



0

x

=



}

0

1

0

:

)

1

0

(

y

=

0

\*

>

0

1

:

1

@

[

/



1

@

1



0

:

<

/

0

\*

0

1

#

%

# HELP YOUR KIDS WITH COMPUTER CODING

0



1

:

/

y

#

1

{

0

1

\*

<

]

1

0

:

1

>

1

)

@

x

#



(

1

0



}

1



0

\

=

\*

0

:

1

0

#

@

A UNIQUE STEP-BY-STEP VISUAL GUIDE,  
FROM BINARY CODE TO BUILDING GAMES



**HELP YOUR KIDS WITH**  
*COMPUTer*  
*CODing*

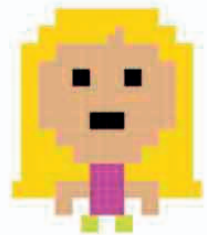

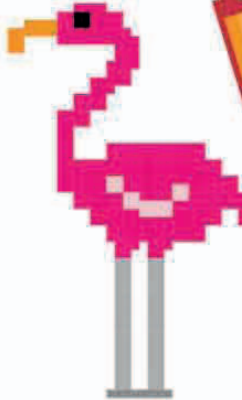
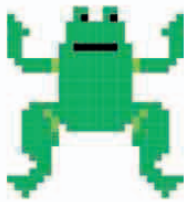
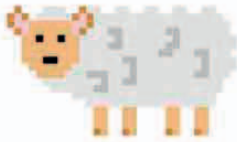
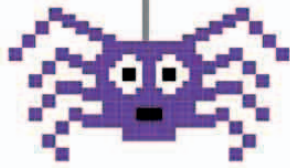



**HELP YOUR KIDS WITH**  
*COMPUTer*  
*CODing*

A UNIQUE STEP-BY-STEP VISUAL GUIDE,  
FROM BINARY CODE TO BUILDING GAMES





LONDON, NEW YORK, MELBOURNE,  
MUNICH, AND DELHI

**DK LONDON**

**Editor** Sam Priddy  
**Designer** Fiona Macdonald  
**Additional editors** Sam Atkinson,  
Lizzie Davey, Daniel Mills, Ben Morgan  
**US editor** Jill Hamilton  
**Additional designer** Simon Murrell  
**Managing editor** Paula Regan  
**Managing art editor** Owen Peyton Jones  
**Senior producer, pre-production** Ben Marcus  
**Senior producer** Mary Slater  
**Jacket editor** Maud Whatley  
**Jacket designer** Laura Brim  
**Jacket design development manager** Sophia MTT  
**Publisher** Sarah Larter  
**Art director** Phil Ormerod  
**Associate publishing director** Liz Wheeler  
**Publishing director** Jonathan Metcalf

**DK INDIA**

**Senior art editor** Devika Dwarkadas  
**Editors** Suefa Lee, Neha Pande  
**Art editors** Sanjay Chauhan,  
Shreya Anand Virmani  
**Assistant art editor** Vanya Mittal  
**DTP designer** Sachin Gupta  
**Managing editor** Rohan Sinha  
**Deputy managing art editor** Sudakshina Basu  
**Pre-production manager** Balwant Singh  
**Jacket designer** Suhita Dharamjit  
**Senior DTP designer** Harish Aggarwal

First American Edition, 2014  
Published in the United States by DK Publishing  
345 Hudson Street, 4th Floor, New York, New York 10014  
14 15 16 17 18 10 9 8 7 6 5 4 3 2 1  
001 – 192672 – Jun/2014

Copyright © 2014 Dorling Kindersley Limited  
All rights reserved. Without limiting the rights under copyright reserved above, no part of this publication may be reproduced, stored in a retrieval system, or transmitted in any form or by any means (electronic, mechanical, photocopying, recording, or otherwise), without the prior written permission of the copyright owner.  
Published in Great Britain by Dorling Kindersley Limited.

A catalog record for this book is available from the Library of Congress.  
ISBN: 978-1-4654-1956-9

DK books are available at special discounts when purchased in bulk for sales promotions, premiums, fund-raising, or educational use. For details, contact: DK Publishing Special Markets, 345 Hudson Street, New York, New York 10014 or SpecialSales@dk.com.

Printed and bound in China by South China Printing Company.  
Discover more at  
[www.dk.com](http://www.dk.com)



**CAROL VORDERMAN M.A. (CANTAB), MBE** is one of Britain's best-loved TV presenters and is renowned for her skills in mathematics. She has a degree in Engineering from the University of Cambridge. Carol has a keen interest in coding, and feels strongly that every child should have the chance to learn such a valuable skill. She has hosted numerous TV shows on science and technology, such as *Tomorrow's World* and *How 2*, as well as *The Pride of Britain Awards*, on the BBC, ITV, and Channel 4. Whether co-hosting Channel 4's *Countdown* for 26 years, becoming the second best selling female nonfiction author of the noughties decade in the UK, or advising British Prime Minister David Cameron on the future of potential mathematics education in the UK, Carol has a passion and devotion to explaining mathematics, science, and technology in an exciting and easily understandable way.



**DR. JON WOODCOCK M.A. (OXON)** has a degree in Physics from the University of Oxford and a Ph.D. in Computational Astrophysics from the University of London. He started coding at the age of eight and has programmed all kinds of computers from single-chip microcontrollers to world-class supercomputers. His many projects include giant space simulations, research in high-tech companies, and intelligent robots made from junk. Jon has a passion for science and technology education, giving talks on space and running computer programming clubs in schools. He has worked on numerous science and technology books as a contributor and consultant.



**SEAN McMANUS** learned to program when he was nine. His first programming language was Logo. Today he is an expert technology author and journalist. His other books include *Scratch Programming in Easy Steps*, *Web Design in Easy Steps*, and *Raspberry Pi For Dummies*. Visit his website at [www.sean.co.uk](http://www.sean.co.uk) for Scratch games and tutorials.



**CRAIG STEELE** is a specialist in Computing Science education. He is Project Manager for CoderDojo Scotland, which runs free coding clubs for young people. Craig has previously worked for the Scottish Qualification Authority, Glasgow Science Centre, and the University of Glasgow. Craig's first computer was a ZX Spectrum.



**CLAIRE QUIGLEY** studied Computing Science at Glasgow University where she obtained a B.S. and a Ph.D. She has worked in the Computer Laboratory at Cambridge University and on a project that aimed to develop computational thinking skills in primary school pupils. She is a mentor at CoderDojo Scotland, a coding club for young people.



**DANIEL McCAFFERTY** holds a degree in Computer Science from the University of Strathclyde. Since graduating, he has been developing software for some of the world's largest investment banks. In his spare time, Daniel is a mentor at CoderDojo Scotland, a coding club for young people.

# Contents

- 8 **FOREWORD** by Carol Vorderman
- 10 **HOW THIS BOOK WORKS**

## 1 WHAT IS CODING?

- 14 What is a computer program?
- 16 Thinking like a computer
- 18 Becoming a coder

## 2 STARTING FROM SCRATCH

- 22 What is Scratch?
- 24 Installing Scratch
- 26 Scratch interface
- 28 Sprites
- 30 Colored blocks and scripts
- 32 **Project 1: Escape the dragon!**
- 38 Making things move
- 40 Costumes
- 42 Hide and seek
- 44 Events
- 46 Simple loops
- 48 Pens and turtles
- 50 Variables
- 52 Math
- 54 Strings and lists
- 56 Coordinates
- 58 Make some noise
- 60 **Project 2: Roll the dice**
- 62 True or false?

- 64 Decisions and branches
- 66 Sensing and detecting
- 68 Complex loops
- 70 Sending messages
- 72 Creating blocks
- 74 **Project 3: Monkey mayhem**
- 82 Time to experiment

## 3 PLAYING WITH PYTHON

- 86 What is Python?
- 88 Installing Python
- 92 Introducing IDLE
- 94 Errors
- 96 **Project 4: Ghost game**
- 98 Ghost game decoded
- 100 Program flow
- 102 Simple commands
- 104 Harder commands
- 106 Which window?
- 108 Variables in Python
- 110 Types of data
- 112 Math in Python
- 114 Strings in Python
- 116 Input and output
- 118 Making decisions
- 120 Branching



- 122 Loops in Python
- 124 While loops
- 126 Escaping loops
- 128 Lists
- 130 Functions
- 132 **Project 5: Silly sentences**
- 134 Tuples and dictionaries
- 136 Lists in variables
- 138 Variables and functions
- 140 **Project 6: Drawing machine**
- 148 Bugs and debugging
- 150 Algorithms
- 152 Libraries
- 154 Making windows
- 156 Color and coordinates
- 158 Making shapes
- 160 Changing things
- 162 Reacting to events
- 164 **Project 7: Bubble blaster**
- 176 What next?

## 4 INSIDE COMPUTERS

- 180 Inside a computer
- 182 Binary and bases
- 184 Symbols and codes
- 186 Logic gates

- 188 Processors and memory
- 190 Essential programs
- 192 Storing data in files
- 194 The Internet

## 5 PROGRAMMING IN THE REAL WORLD

- 198 Computer languages
- 200 Coding stars
- 202 Busy programs
- 204 Computer games
- 206 Making apps
- 208 Programming for the Internet
- 210 Using JavaScript
- 212 Bad programs
- 214 Mini computers
- 216 Becoming a master programmer
  
- 218 Glossary
- 220 Index
- 224 Acknowledgments

Find out more at:

[www.dk.com/computercoding](http://www.dk.com/computercoding)



# Foreword

---

---

---

---

Just a few years ago, computer coding seemed like a mysterious skill that could only be practiced by specialists. To many people, the idea that coding could be fun was a strange one. But then the world changed. In the space of a few years, the Internet, email, social networks, smartphones, and apps hit us like a tornado, transforming the way we live.

Computers are a huge part of life that we all now take for granted. Instead of calling someone on the phone, we send a text message or use social media. From shopping and entertainment to news and games, we guzzle everything computers have to offer. But we can do more than just use this technology, we can create it. If we can learn to code, we can make our own digital masterpieces.

Everything computers do is controlled by lines of code that someone has typed out on a keyboard. It might look like a foreign language, but it's a language anybody can pick up quite quickly. Many would argue that coding has become one of the most important skills you can learn in the 21st century.

---

---

---

Learning to code is tremendous fun because you can get instant results, no matter how much more you have to learn. In fact, it's such fun creating games and programs that it feels effortless once you're hooked. It's also creative—perhaps the first science that combines art, logic, storytelling, and business.

Not only that, coding is a fantastic skill for life. It strengthens logical thinking and problem-solving skills—vital in many different areas of life, from science and engineering to medicine and law. The number of jobs that require coding is set to increase dramatically in the future, and there's already a shortage of good coders. Learn to code, and the digital world is yours for the taking!

*Carol Vorderman*

CAROL VORDERMAN



# How this book works

This book introduces all the essential concepts needed to understand computer coding. Fun projects throughout put these ideas into practice. Everything is broken down into small chunks so that it's easy to follow and understand.



Each topic is described in detail, with examples and exercises

"See also" boxes list other subjects that are linked to the topic

## 42 STARTING FROM SCRATCH

# Hide and seek

Welcome to the special effects studio! Using the purple "Looks" blocks, find out how to make sprites vanish and reappear, grow and shrink, and fade in and out.

**Hiding sprites**  
To make a sprite disappear, use the "hide" block. The sprite is still on the stage, and it can still move around, but it can't be seen unless the "show" block is used to make it visible again.

**SEE ALSO**

◀ 38-39 Making things move

▶ Sending 70-71 messages

Use the "hide" block to make sprites disappear in games

**Hide and show**  
To make a sprite vanish, use the "hide" block. When you're ready for it to be seen again, use the "show" block. These blocks are found in the "Looks" section of the blocks palette.

hide

show

**Disappearing cat**  
Try this script using the cat sprite. It disappears and reappears but it keeps moving, even when you can't see it.

```

when clicked
  forever
    wait 1 secs
    hide
    turn 90 degrees
    move 100 steps
    wait 1 secs
    show
            
```

This block hides the cat

This block rotates the cat clockwise

The cat still moves even when hidden

This block shows the cat again

## 170 PLAYING WITH PY

# BUBBLE BLASTER

**Figuring out the distance**  
In this game, and lots of others, it is between two objects. Here's how to formula to have the computer work

11 This function calculates the distance between two objects. Add this bit of code directly to the code you wrote in step 9.

```

from math import sqrt
def distance(id1, id2):
    x1, y1 = get_coords(id1)
    x2, y2 = get_coords(id2)
    return sqrt((x2 - x1)
            
```

## Sizes and effects

Scripts can be used to change the size of a sprite and add special effects to it.

change size by 10

Type in positive numbers to make sprites bigger and negative numbers to make them smaller

set size to 100 %

Higher numbers make sprites bigger and lower numbers make them smaller. 100 is normal size

△ Changing a sprite's size  
These two blocks can be used to make a sprite bigger or smaller, either by a set amount or by a percentage of its size.

Resets all the effects

△ Add...  
The gap used to or distort experim

## Using effects to teleport

Add a ghost sprite from the "Fantasy" category of the sprite library, and create the script shown below. It makes the ghost appear to teleport when clicked.

```

when this sprite clicked
  clear graphic effects
  repeat (20)
    change ghost effect by 5
  glide (0.1) secs to x: pick random (-150) to (150) y: pi
  repeat (20)
    change ghost effect by (-5)
            
```

The "ghost" effect makes the fade slightly; by repeating the block 20 times the sprite fades away completely

This "Opera" selects a random horizontal

Using this block makes the sprite fade back in

Colorful illustrations highlight different programming concepts

Programming scripts and code are explained line by line

Instructions show what to click, drag, or select

Labels help explain each step

Seven projects build up coding skills. Project pages are highlighted with a blue band

Simple step-by-step instructions guide you through each project



Distance between points

Useful to know the distance between two points. Use a well-known mathematical formula to work it out.

Get the position of the first object  
 Get the position of the second object  
 Gives back the distance between them  
 $\sqrt{(x2 - x1)^2 + (y2 - y1)^2}$

HIDE AND SEEK 43

Change the numbers in the blocks to set how strong the effect is  
 pixelate effect by (25)  
 effect to (0)  
 Each color is represented by a number. Change the number to set the color  
 graphic effects  
 graphic effects in Scratch can be used to change a sprite's appearance and its shape. They're fun to experiment with.

You'll never know where I'll appear next!  
 This block selects a random vertical position  
 block random (-150) to (150)  
 This block makes the ghost move slowly, hidden from view

13

Now update the main game loop to use the functions you have just created. Remember that the order is important, so make sure you put everything in the right place. Then run the code. Bubbles should burst when they hit the sub. Check the shell window to see the score.

```
score = 0
#MAIN GAME LOOP
while True:
    if randint(1, BUB_CHANCE) == 1:
        create_bubble()
    move_bubbles()
    clean_up_bubs()
    score += collision()
    print(score)
    window.update()
    sleep(0.01)
```

**EXPERT TIPS**  
**Python shortcut**  
 The code "score += collision()" is a shortcut for writing "score = score + collision()". It adds the collision score to the total score, then updates the total score. Code like this is common, so a shortcut is useful. You can also do the same thing using the "--" symbol. For example, "score -= 10" is the same as "score = score - 10".



Each line of code is clearly labeled so you can't go wrong

This icon indicates that the project continues on the next page

Boxes give extra information: tips, definitions, and things to remember



**EXPERT TIPS**

### When to save

This save icon appears on the project spreads. It reminds you when to save the work you've done, so that nothing is lost if the computer crashes. Always remember to save your work frequently.

**T**

# What is coding?



# What is a computer program?

A computer program is a set of instructions that a computer follows to complete a task. “Coding”, or “programming”, means writing the step-by-step instructions that tell the computer what to do.

## Computer programs are everywhere

We are surrounded by computer programs. Many of the devices and gadgets we use every day are controlled by them. These machines all follow step-by-step instructions written by a computer programmer.

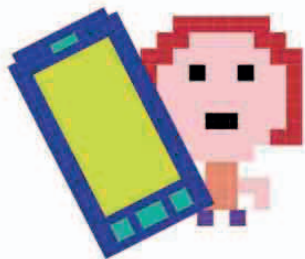

### ◁ Mobile phones

Programs allow you to make a phone call or send text messages. When you search for a contact, a program finds the correct phone number.

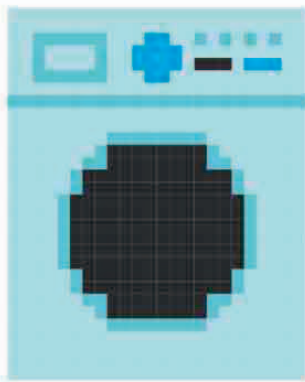

### △ Washing machines

Washing machines are programmed to follow different cycles. Computer code controls how hot the water is and how long the wash takes.

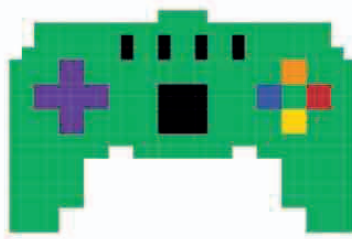

### ◁ Games

Consoles are just another type of computer, and all the games that run on them are programs. All the graphics, sounds, and controls are written in computer code.

### ▷ Cars

In some cars, computer programs monitor the speed, temperature, and amount of fuel in the tank. Computer programs can even help control the brakes to keep people safe.

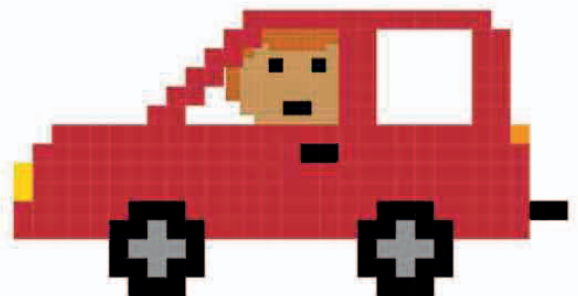

## SEE ALSO

Thinking like **16–17** ›  
a computer

Becoming **18–19** ›  
a coder

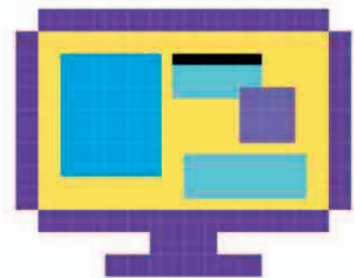

### △ Computer software

Everything a computer does, from browsing the Internet to writing documents or playing music, works because of code written by a computer programmer.



## How computer programs work

Computers might seem very smart, but they are actually just boxes that follow instructions very quickly and accurately. As intelligent humans, we can get them to carry out different tasks by writing programs, or lists of instructions.

### 1 Computers can't think

A computer won't do anything by itself. It's up to the computer programmer to give it instructions.



Without instructions a computer is clueless

### 2 Write a program

You can tell a computer what to do by writing a set of very detailed instructions called a program. Each instruction has to be small enough that the computer can understand it. If the instructions are incorrect, the computer won't behave the way you want it to.

This is a computer program counting down to launch

```
for count in range(10, 0, -1):
    print("Counting down", count)
```

### 3 Programming languages

Computers can only follow instructions in a language they understand. It's up to the programmer to choose which language is best for the task.

```
for count in range(10, 0, -1):
    print("Counting down", count)
```

All programs are finally converted into "binary code", a basic computer language that uses only ones and zeroes

```
0010 0011 1000 1100
1000 0110 0100 1001
0100 1001 0001 0101
```

# BLAST OFF!



#### LINGO

### Hardware and software

"Hardware" means the physical parts of the computer that you can see or touch (all the wires, the circuits, the keyboard, the display screen, and so on). "Software" means the programs that run on the computer and control how it works. Software and hardware work together to make computers do useful things.

# Think like a computer

A programmer must learn to think like a computer. All tasks must be broken down into small chunks so that they are easy to follow and impossible to get wrong.

## SEE ALSO

◀ 14–15 What is a computer program?

Becoming 18–19 ▶  
a coder

## Thinking like a robot

Imagine a café where the waiter is a robot. The robot has a simple computer brain, and needs to be told how to get from the café kitchen to serve food to diners seated at tables. First the process has to be broken down into simple tasks the computer can understand.



### LINGO

## Algorithm

An algorithm is a set of simple instructions for performing a task. A program is an algorithm that has been translated into a language that computers can understand.

### 1 Waiter robot program 1

Using this program the robot grabs the food from the plate, crashes straight through the kitchen wall into the dining area, and puts the food on the floor. This algorithm wasn't detailed enough.

1. Pick up food
2. Move from kitchen to diner's table
3. Put food down

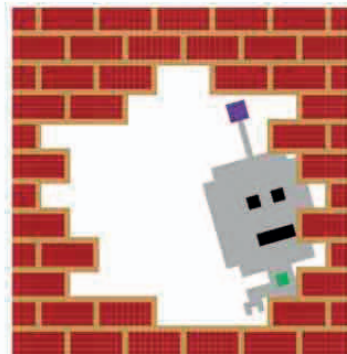

### ◁ Disaster!

The instructions weren't clear: we forgot to tell the robot to use the door. It might seem obvious to humans but computers can't think for themselves.

### 2 Waiter robot program 2

This time we've told the robot waiter to use the kitchen door. It makes it through the door, but then hits the café cat, trips, and smashes the plate on the floor.

1. Pick up a plate with food on it
2. Move from kitchen to diner's table by:
  - Move to door between kitchen and dining area
  - Move from door to the table
3. Put plate down on the table in front of the diner

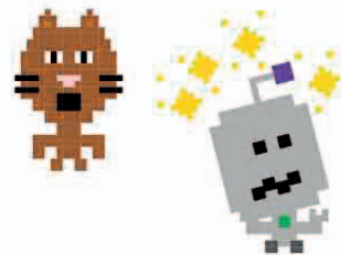

### △ Still not perfect

The robot doesn't know how to deal with obstacles like the cat. The program needs to give the robot even more detailed instructions so it can move around safely.

### 3 Waiter robot program 3

In this version of the program, the robot successfully delivers the food to the diner avoiding any obstacles. But after putting the plate down, the robot remains standing at the table while food piles up in the kitchen.

1. Pick up a plate with food on it holding it level at all times

2. Move from kitchen to diner's table by:

Move to door between kitchen and dining area

checking for obstacles and steering around them

Move from door to the table

checking for obstacles and steering around them

3. Put plate down on the table in front of the diner

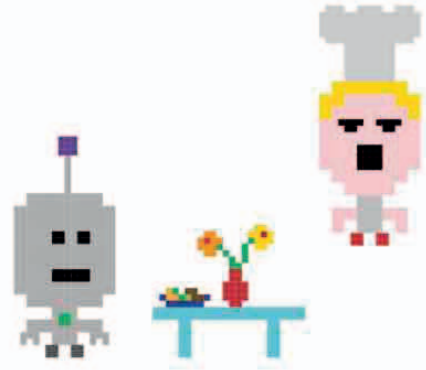

#### △ Success at last?

Finally the robot can deliver the food safely. But we forgot to give it instructions to go back to the kitchen and get the next plate.

## Real-world example

The waiter robot might be imaginary, but algorithms like this are in action all around us. For example, a computer-controlled elevator faces the same sort of problems. Should it go up or down? Which floor should it go to next?

1. Wait until doors are closed

2. Wait for button to be pressed

If button pressed is higher than current floor:

Move lift upwards

If button pressed is lower than current floor:

Move lift downwards

3. Wait until current floor equals button pressed

4. Open doors

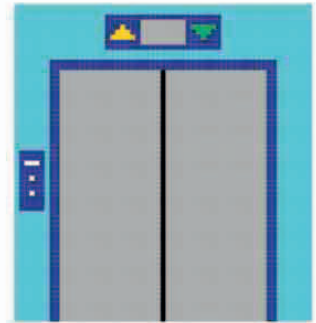

#### ◁ Elevator program

For the elevator to work correctly and safely, every step has to be precise, clear, and cover every possibility. The programmers have to make sure that they create a suitable algorithm.

# Becoming a coder

Coders are the people who write the programs behind everything we see and do on a computer. You can create your own programs by learning a programming language.

## SEE ALSO

What is **22-23** ›  
Scratch?

What is **86-87** ›  
Python?

## Programming languages

There are a huge range of programming languages to choose from. Each one can be used for different tasks. Here are some of the most popular languages and what they are often used for:

**C** A powerful language for building computer operating systems.

**Ada** Used to control spacecraft, satellites, and airplanes.

**Java** Works on computers, cell phones, and tablets.

**MATLAB** Ideal for programs that need to carry out lots of calculations.

**Ruby** Automatically turns lots of information into web pages.

**Javascript** A language used to build interactive websites.

## Scratch

A visual language that's ideal for learning programming. This is the first language covered in this book.



## Python

A text-based language that can be used to build all kinds of things. It's the second language covered in this book.

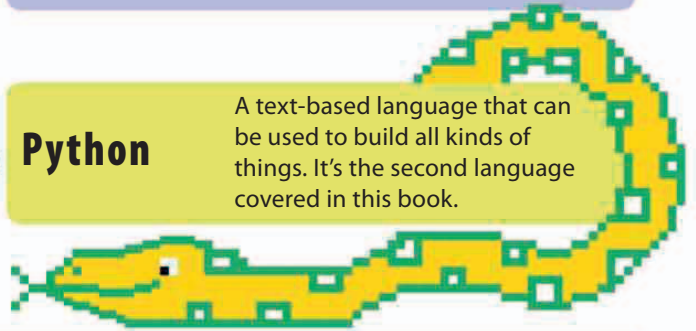

## What is Scratch?

Scratch is a great way to start coding. Programs are created by connecting together blocks of code, instead of typing it out. Scratch is quick and easy to use, and also teaches you the key ideas you need to use other programming languages.

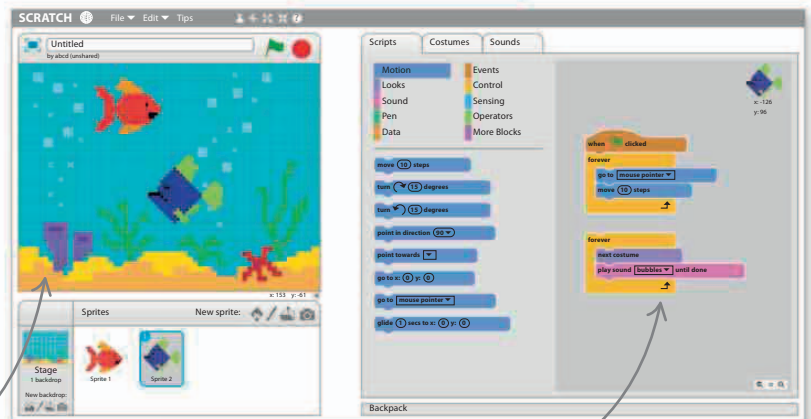

The program appears on this side of the screen

Code is made by connecting colored blocks together

## What is Python?

People around the world use Python to build games, tools, and websites. It's a great language to master because it can help you build all kinds of different programs. Python looks like a mixture of recognizable words and characters, so it can be easily read and understood by humans.

A program written  
in Python

```
IDLE  File  Edit  Shell  Debug  Window  Help
ghostgame

# Ghost Game
from random import randint
print('Ghost Game')
feeling_brave = True
score = 0
while feeling_brave:
    ghost_door = randint(1, 3)
    print('Three doors ahead...')
```

## Getting started

It's time to start programming. All you need is a computer with an Internet connection. This book starts with Scratch—the perfect language to help you on your way to becoming a coding expert. Get ready to jump into the exciting world of computer coding.

### EXPERT TIPS

#### Enjoy experimenting

As a programmer you should experiment with the code and programs you make. One of the best ways to learn programming is to play around and see what happens when you change different parts of the code. By tinkering and fiddling, you'll discover new ways of doing things. You'll learn much more about computer programming and have even more fun.

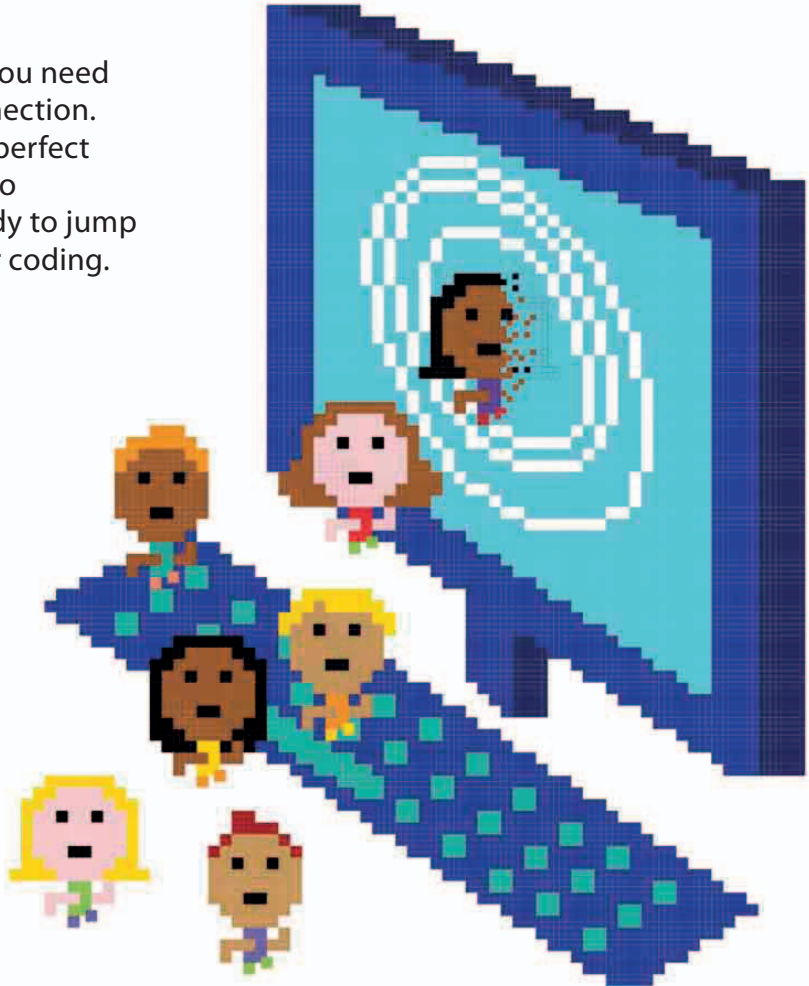



# Starting from Scratch



# What is Scratch?

Scratch is a visual programming language that makes coding simple. It can be used to make all sorts of fun and interesting programs.

## SEE ALSO

Installing and launching Scratch **24–25** ›

Scratch interface **26–27** ›

Colored blocks and scripts **30–31** ›

## Understanding Scratch

Scratch is perfect for making games and animations. It has large collections (or “libraries”) of cool graphics and sounds that you can play around with.

Blocks lock together like jigsaw pieces

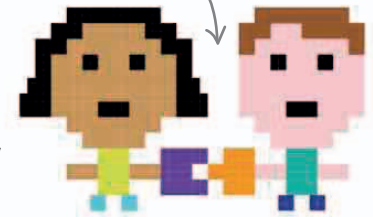

### 1 Start programming

Scratch is a programming language. There's not much typing, and it's easy to get started.

Write your first program in Scratch!

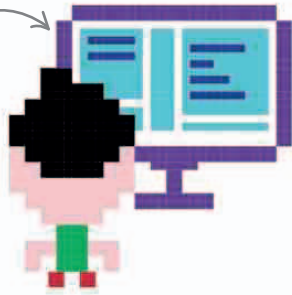

### 2 Put together programming blocks

Scratch uses colored blocks of code. Blocks are selected and joined together to make a script, which is a set of instructions.

### 3 Make sprites move and speak

Objects such as people, vehicles, and animals can be added to a program. These objects are called sprites. Scripts make them move and speak.

Sprites like me can be programmed to talk in speech bubbles.

Sprites can be programmed to walk, run, and dance



## LINGO

### Why is it called Scratch?

“Scratching” is a way of mixing different sounds to make new music. The Scratch programming language enables you to mix pictures, sounds, and scripts to make new computer programs.





## A typical Scratch program

Here is an example of a Scratch program. All of the action takes place in an area on the screen called the “stage.” Background images and sprites can be added to the stage, and you can write scripts to make things happen.

### ▷ Running a program

Starting a program is called “running” it. To run a program in Scratch, click the green flag above the stage.

The red button stops a program

The green flag runs a program

Background image

Adding a script makes the shark sprite move

Several sprites can be on the stage at once

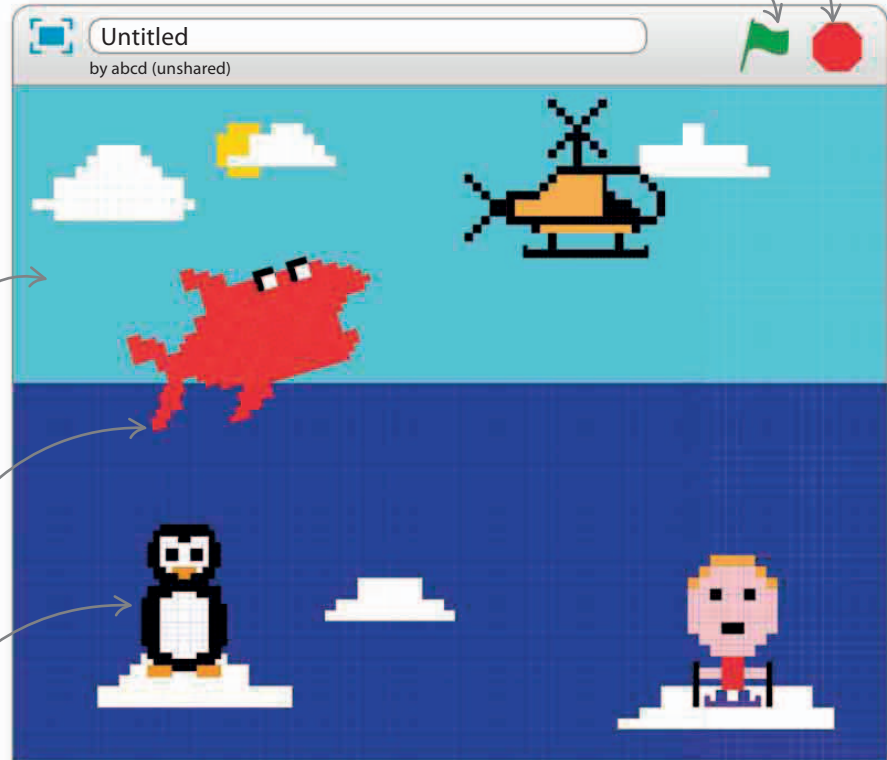

### ▷ Scripts make sprites move

Scratch contains blocks that can be used to make scripts. This script makes the shark bounce around the screen. The “next costume” block makes it open and close its mouth with each movement.

The “forever” block keeps the sprite moving endlessly

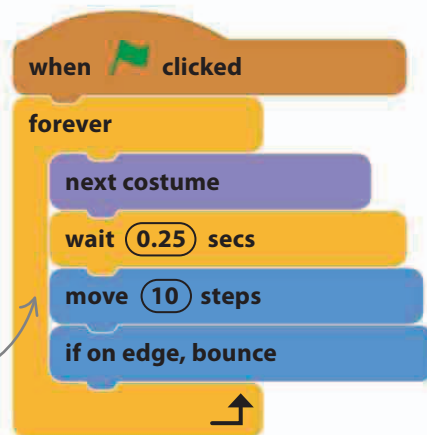

### REMEMBER

## Scratch programs

In Scratch, when you save your work it is called a “project.” A project includes all the sprites, backgrounds, sounds, and scripts you’re working with. When you load a project again later, everything will be where it was when you saved it. A Scratch project is a computer program.

# Installing and launching Scratch

To start programming in Scratch, you need to have the Scratch software. It can be installed on a computer, or it can be used online.

## Create a Scratch account

A Scratch account can be used to share the programs you make on the Scratch website. It's also used to save work online. Visit the Scratch website at: <http://scratch.mit.edu/> and click "Join Scratch" to create your account.

### ▷ Getting started

The way Scratch is set up depends on whether it's used over the Internet (online) or from downloaded software (offline).



## 1 Set-up

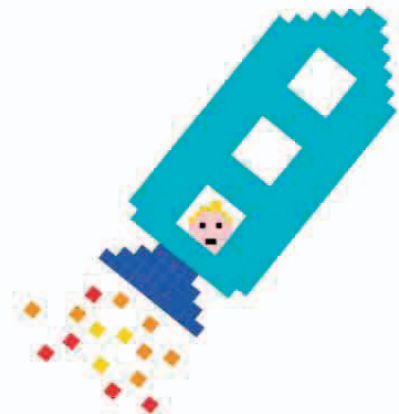

## 2 Launching Scratch

### REMEMBER

#### Scratch website

Find the Scratch website at:  
<http://scratch.mit.edu/>

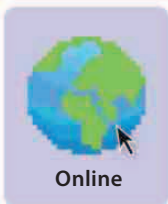
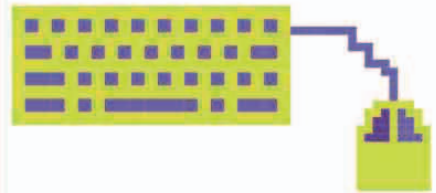

Visit <http://scratch.mit.edu> and click "Join Scratch." Fill in the form to create a username and password. Make sure you get permission from your parent or caregiver to join the website.

Once you've joined the Scratch website, click "Sign in," and enter your username and password. Click "Create" at the top of the screen to begin a new program.



Download the software version of Scratch at: <http://scratch.mit.edu/scratch2download/>. Run the installation program and a Scratch icon will appear on your desktop.

Double-click the icon on the desktop and Scratch will start, ready to begin programming.

## EXPERT TIPS

**Mouse control**

The “click” instruction means press the left mouse button if there is more than one. “Right-click” means use the right mouse button. If a mouse only has one button, hold the “CTRL” key on the keyboard and press the mouse button to perform a right-click.

**3 Saving work**

When you’re logged in, Scratch automatically saves work for you. To find your work, click your username at the top right of the screen and click “My Stuff.”

Click the “File” menu at the top of the screen and choose “Save As.” Ask the person who owns the computer where you should save your work.

**Different versions of Scratch**

This book uses Scratch 2.0, the latest version of Scratch. Use this version if possible. An older version will differ slightly.

△ **Scratch 1.4**

The older version of Scratch has the stage on the right of the screen.

△ **Scratch 2.0**

The latest version of Scratch has some new commands and the stage is on the left of the screen.

**4 Operating systems**

The web version of Scratch works well on Windows, Ubuntu, and Mac operating systems. It needs Adobe Flash software, though, so it won’t work on some tablets.

The offline version of Scratch works well on computers with Windows and Mac operating systems. It doesn’t work well on computers that use Ubuntu. If a computer uses Ubuntu, try the online version instead.

Ready?  
Let’s go!



# Scratch interface

This is Scratch's screen layout, or "interface."  
The stage is on the left and programs are created on the right.

## ▽ Experiment

Click the buttons and tabs to explore and experiment with the Scratch interface. The projects that follow explain how to use them.

■ ■ **EXPERT TIPS**

## Menu and tools

### MENU OPTIONS

This is what the menu options at the top of the screen do.

File ▾ **Save work** or start a new project.

Edit ▾ **Undo any mistakes** or change the stage size.

Tips **If you get stuck**, find help here.

### CURSOR TOOLS

Click on the tool you want to use, and then click on the sprite or script that you want to use it on.

👤 **Copy** a sprite or script.

✂️ **Delete** a sprite or script.

🔍 **Enlarge** a sprite.

🔍 **Shrink** a sprite.

❓ **Get help** on a block.

The screenshot shows the Scratch interface with several annotations:

- Click for full screen view**: Points to the full-screen button in the top toolbar.
- Change language**: Points to the globe icon in the top toolbar.
- Menu options**: Points to the File, Edit, and Tips menus in the top toolbar.
- Cursor tools**: Points to the copy, delete, enlarge, and shrink icons in the top toolbar.
- Program name box**: Points to the text box containing "Untitled" and "by abcd (unshared)".
- Click a sprite on the stage or in the sprite list to select it**: Points to the green frog sprite on the stage.
- Buttons to change the backdrop**: Points to the backdrop selection buttons in the bottom toolbar.
- Blue box around the selected sprite**: Points to the blue border around the owl sprite in the sprite list.
- Buttons to add new sprites**: Points to the buttons for adding new sprites in the bottom toolbar.

▷ **Scratch map**

The stage is where programs run. Sprites are managed in the sprite list and script blocks can be found in the blocks palette. Build scripts in the scripts area.



STAGE LIST

BACKPACK

Sounds tab

Costumes tab

Scripts tab

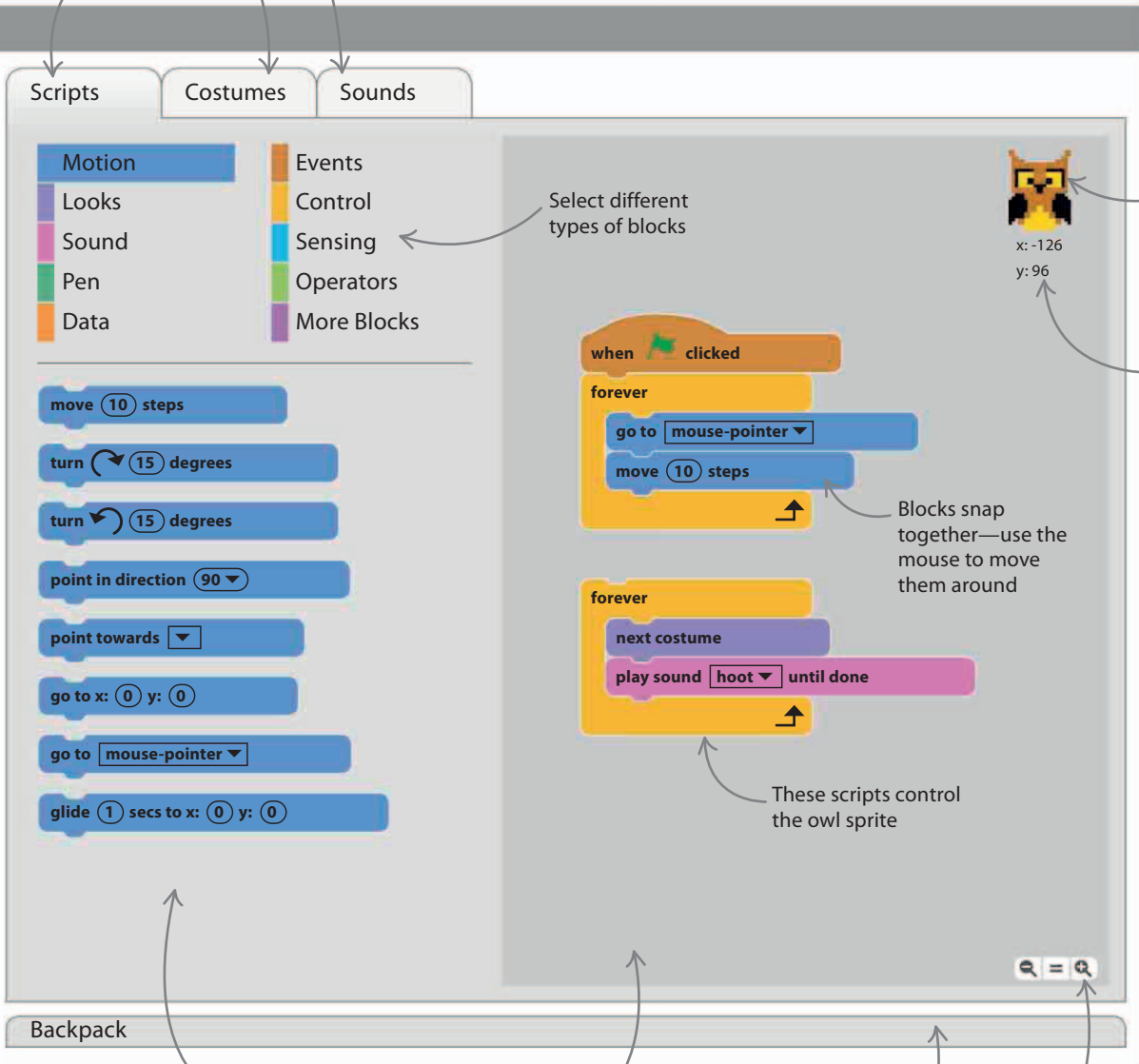

Select different types of blocks

Current sprite selected

Position of the current sprite on the stage

Blocks snap together—use the mouse to move them around

These scripts control the owl sprite

Backpack

Drag blocks from here into the scripts area to make scripts

Build scripts here

Store scripts, sprites, sounds and costumes in the backpack

Zoom in on scripts

# Sprites

Sprites are the basic components of Scratch. Every Scratch program is made up of sprites and the scripts that control them. The “Escape the dragon!” program on pages 32–37 uses the cat, dragon, and donut sprites.

## SEE ALSO

◀ 26–27 Scratch interface

Costumes 40–41 ▶

Hide and seek 42–43 ▶

## What can sprites do?

Sprites are the images on the stage. Scripts are programmed to make them do things. Sprites can be instructed to react to other sprites and the user of the program. Here are a few things sprites can do:

**Move around the stage**

**React when they touch things**

**Change their appearance**

**Be controlled by the user**

**Play sounds and music**

**Talk in speech bubbles**

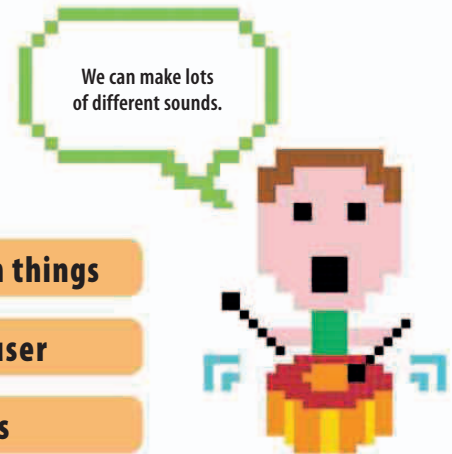

## Sprites in the Scratch interface

Each project can have several sprites, and each one can have its own scripts. It's important to add scripts to the correct sprite, and to know how to switch between them.

The scripts being shown here belong to the sprite shown here

Select different sprites by clicking on them

▷ **Sprites and scripts**  
A project can have lots of sprites, and each sprite can have lots of scripts.

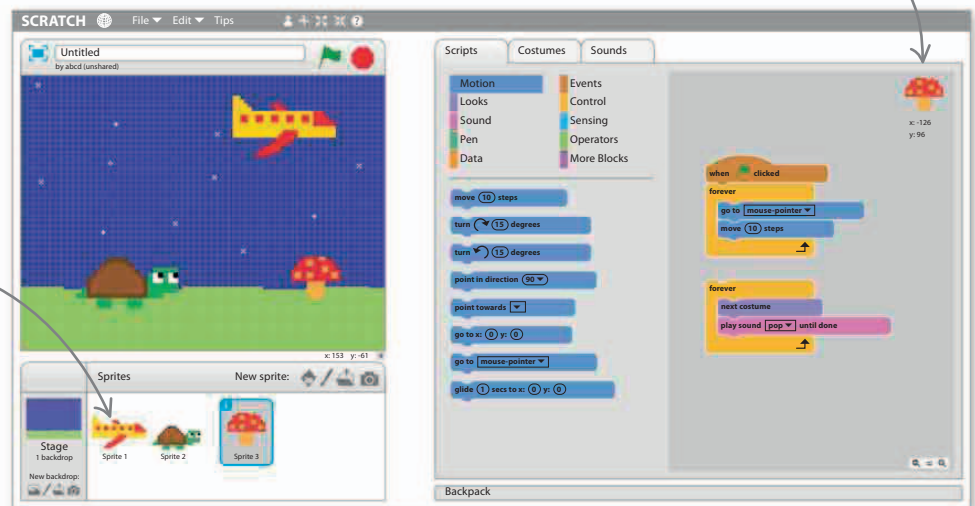

## Creating and editing sprites

Games are more exciting when there are more sprites to hit, dodge, or chase each other around the stage.

It's simple to create, copy, and delete sprites.

### ▽ Create a sprite

Use the buttons above the sprite list to add or create a sprite for your program.

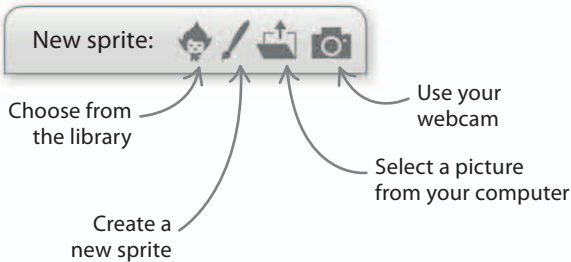

### ▽ Copy or delete a sprite

To copy a sprite and its scripts, right-click on it in the sprite list and choose "duplicate."

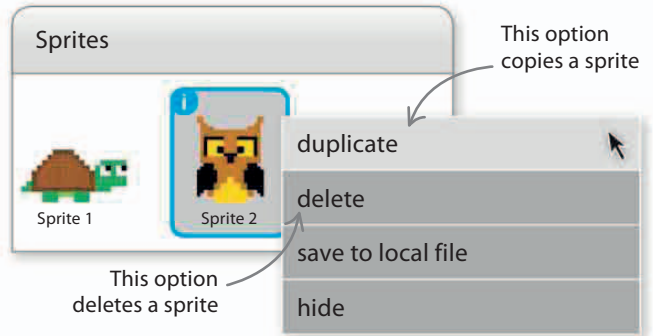

## Naming a sprite

When you start a new program in Scratch the cat sprite is called "Sprite1." It's easier to write programs if you give your sprites more meaningful names. It also makes it easier to understand and manage scripts.

### 1 Select the sprite

Select a sprite in the sprite list, and then click on the blue "i" button in the corner.

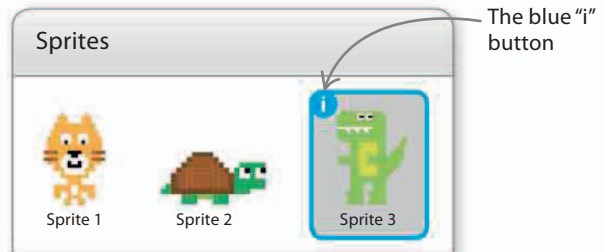

### 2 Change the name

When the information panel opens, click on the text box and use the keyboard to change the name of the sprite.

Type the sprite's new name here

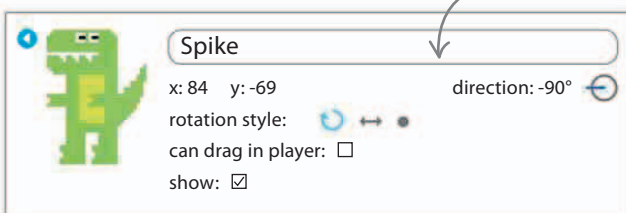

### 3 Renamed sprite

Click the blue arrow to the left of the sprite to close the information panel.

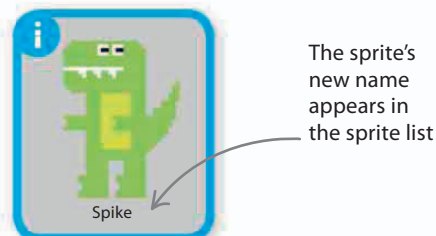

# Colored blocks and scripts

Blocks are color-coded depending on what they do. Putting them together builds scripts that run in the order in which they are placed.

## Colored blocks

There are ten different types of blocks in Scratch. Switch between them using the buttons in the blocks palette. Click on a color to see all the blocks in that section.

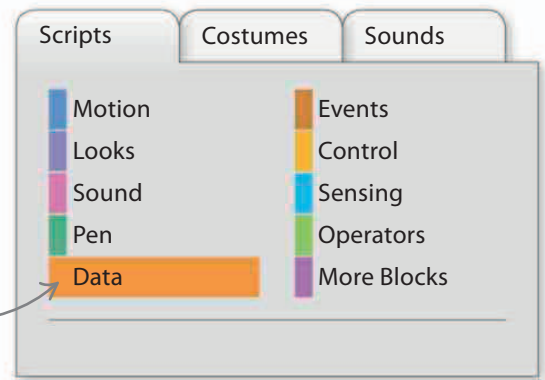

### SEE ALSO

◀ 26–27 Scratch interface

Escape the 32–37 ▶ dragon!

## Functions of blocks

Different types of blocks do different things in programs. Some of them make sprites move, some manage sounds, and some decide when things happen.

### ▽ Events and sensing

Brown “Events” blocks make things happen. Light blue “Sensing” blocks detect information about the keyboard, mouse, and what a sprite is touching.



### ▽ Motion, looks, sound, and pen

These blocks control what a sprite does on screen—this is called the output of a program. Pick a sprite and try each block to see what it does.

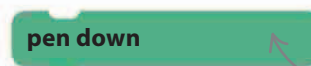
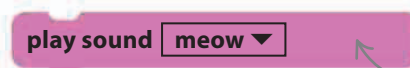



▽ **Data and operators**

Orange “Data” blocks and green “Operators” blocks store numbers and words and do things with them.



▽ **Control**

The “Control” blocks make decisions about when blocks run. They can be programmed to repeat instructions.

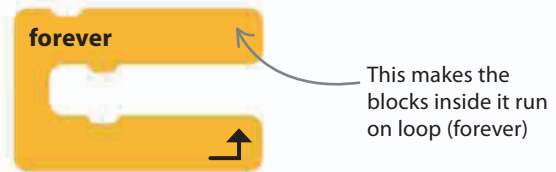

## Flow of scripts

When a program runs, Scratch carries out the instructions on the blocks. It starts at the top of the scripts and works its way down.

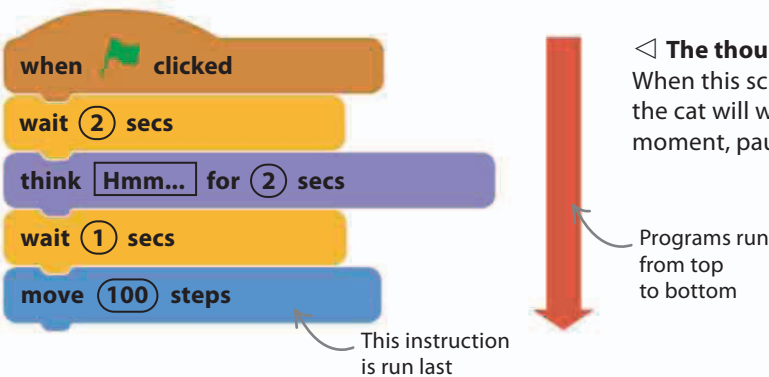

◁ **The thoughtful cat**

When this script is used with the cat sprite, the cat will wait 2 seconds, think for a moment, pause 1 second, and then move.

## Running scripts

When a script is running, it glows. Use the green flag button on the stage to run a script or click a script or a block to make it run.

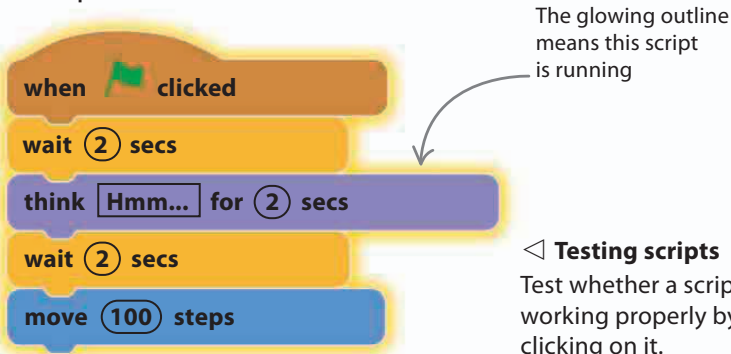

**REMEMBER**

### Stopping scripts

To stop all scripts in a program that are running, click the red stop button above the stage. It's shaped like a hexagon. You'll find it beside the green flag button used to start your program.

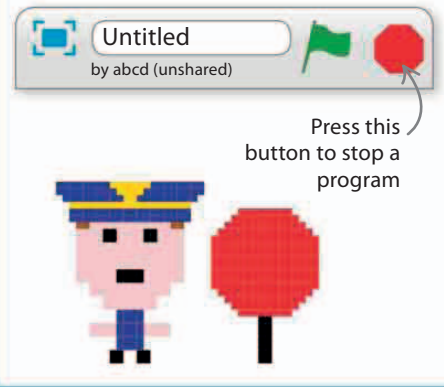

## PROJECT 1

# Escape the dragon!

This project introduces some basic Scratch coding. It shows how to make a game to help the cat sprite dodge a fire-breathing dragon.

### SEE ALSO

◀ 24–25 Installing and launching Scratch

◀ 26–27 Scratch interface

## Make the cat move

This stage explains how to make the cat sprite move around and chase the mouse-pointer. Follow the instructions carefully because otherwise the game might not work.

- 1** Open Scratch. Click “File” on the menu and select “New” to start a new project. The cat sprite appears.



- 2** Click the yellow “Control” button in the blocks palette. Then click the “forever” block, keep the mouse button pressed down, and drag the block into the scripts area on the right. Release the button to drop the block.

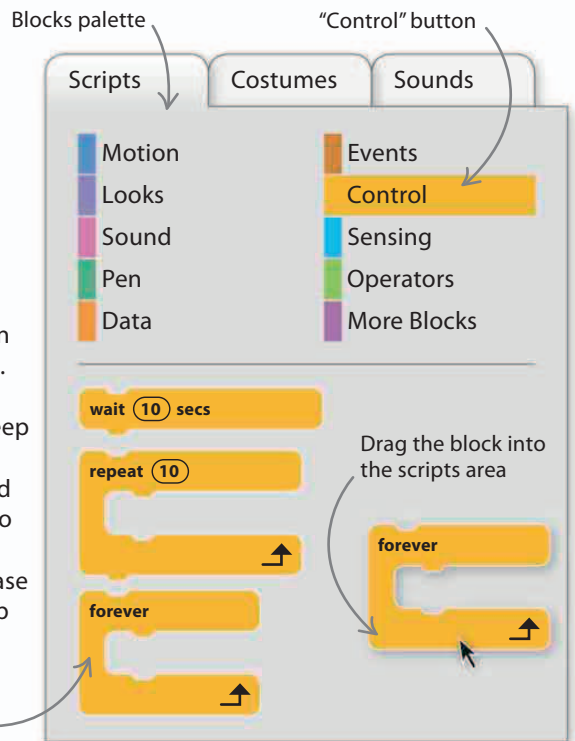

- 3** Click the blue “Motion” button in the blocks palette. The blue “Motion” commands will appear. Drag the “point toward” block into the scripts area and drop it inside the “forever” block. Click the black arrow in the block and choose “mouse-pointer.”

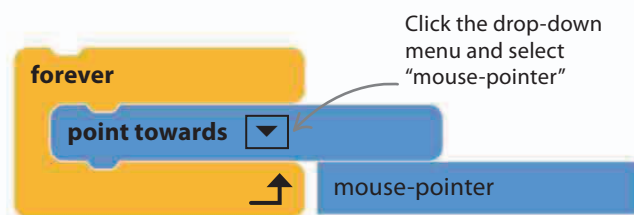

- 4** Click the “Events” button in the blocks palette. Drag the “when green flag clicked” block into the scripts area. Join it to the top of your script.

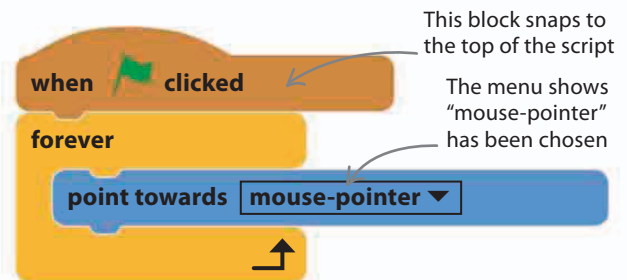

**5** Try running the program by clicking the green flag at the top of the stage. As you move the mouse around the stage, the cat turns to face the mouse-pointer.

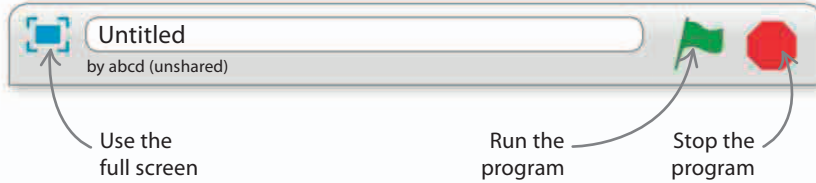

Move the mouse and watch the cat spin around following it

**6** Click the "Motion" button again, and drag the "move 10 steps" block into the scripts area. Drop it inside the "forever" block. Click the green flag button so the cat chases the mouse-pointer!

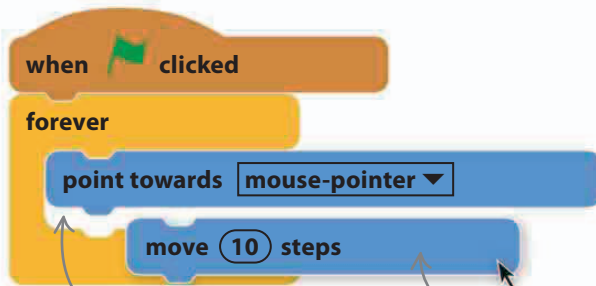

The "forever" block automatically stretches to make room

Drop this block inside the "forever" block

**7** The picture behind the sprites is called a backdrop. To the left of the sprite list is a button to add a backdrop from the library. Click it, then select the "Space" theme from the list. Click the "stars" image and then click the "OK" button at the bottom right.

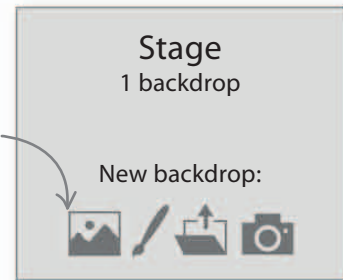

Choose backdrop from the library

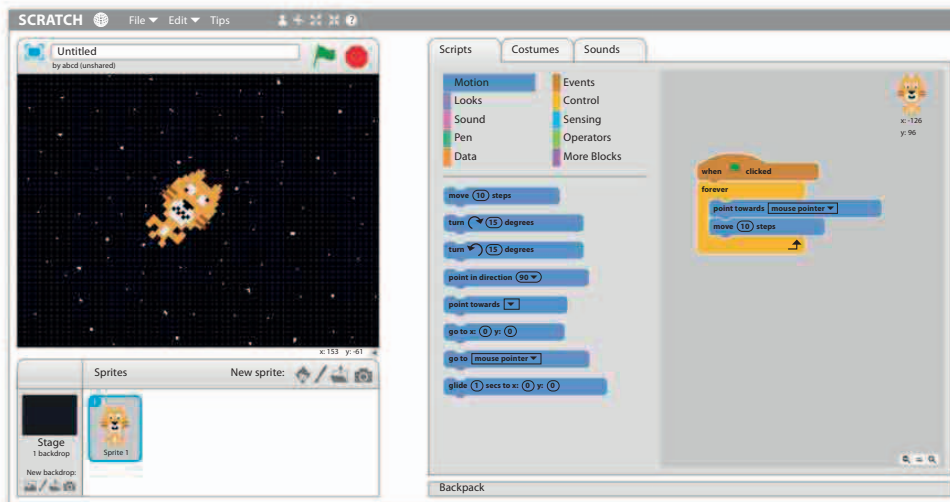

**◀ Cat in space**

The Scratch interface now looks like this. Run the program and the cat chases the mouse-pointer through space.



Scratch automatically saves work if you're online. To save work while offline—click "File" and select "Save As."



## ESCAPE THE DRAGON!

### Add a fire-breathing dragon

Now that the cat can chase the mouse, make a dragon to chase the cat. Don't let the dragon catch the cat, or it will get scorched.

- 8** Above the sprite list is a button to add a sprite from the library. Click it, choose the "Fantasy" category from the menu on the left, and select "Dragon." Click the "OK" button in the bottom-right of the screen.



- 9** Add this script to the dragon sprite. Click the color-coded buttons in the blocks palette to select the blocks below, then drag the blocks into the scripts area. The dragon will now chase the cat.

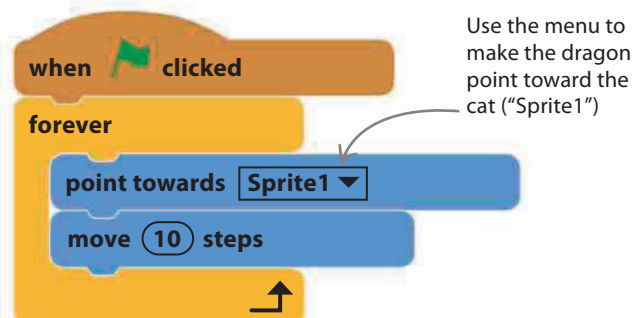

- 10** Click the blue "Motion" button and drag the "go to x:0 y:0" block into the script. Click the number boxes in the block and change them to -200 and -150. Click the purple "Looks" button and add the "switch costume to" block to your script.

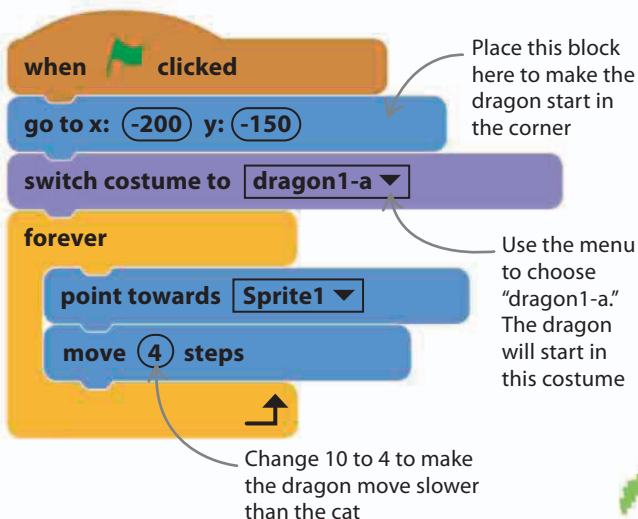

- 11** With the dragon sprite highlighted, add this second script to the scripts area. The "wait until" block is found in the "Control" section, and the "touching" block is in the "Sensing" section. The dragon now breathes fire when it touches the cat.



**12** In coding, a “variable” is used to store information. This step uses a variable to create a timer to measure how long a player survives before getting toasted. Click the “Data” button and then click “Make a Variable.”

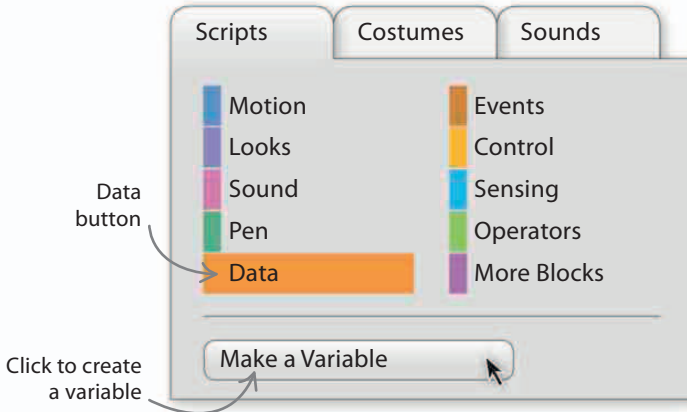

**13** Type in the variable name “Time” and make sure the “For all sprites” button is selected underneath, then click “OK.” This means that the cat, dragon, and any other sprites can use the variable.

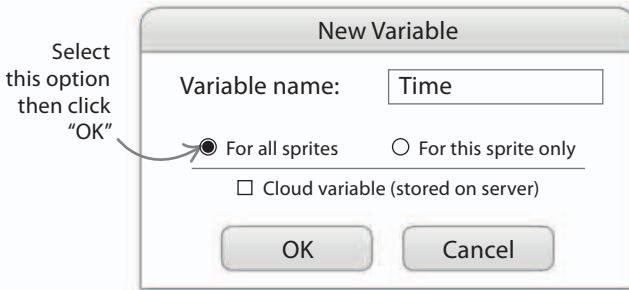

**14** The variable name and the number in it appear on the stage in a small box. Right-click it and choose “large readout.” This shows just the number in the box.

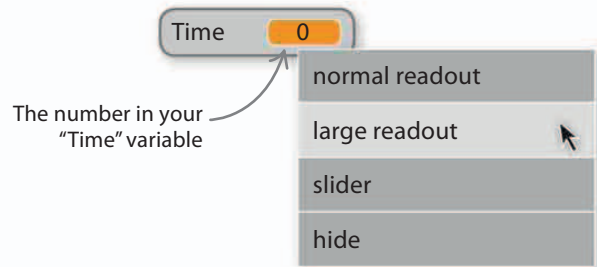

**15** Making a variable adds new blocks to the “Data” section of the blocks palette. Drag the “set Time to 0” and “change Time by 1” blocks from the “Data” section to the scripts area to make this new script. You can give this script to any sprite.

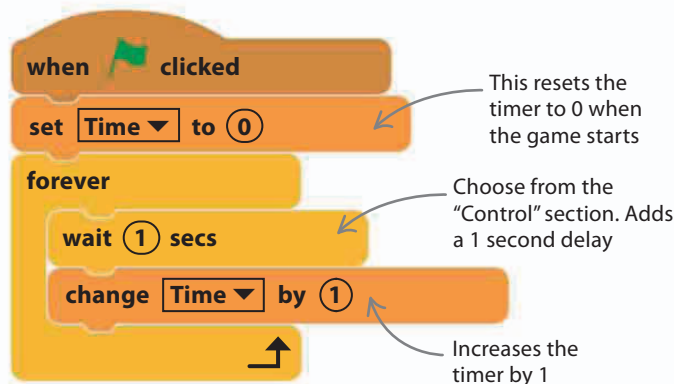

EXPERT TIPS

**Make the game harder**

Try changing the speed or size of your sprites.

**Make the dragon faster:**

move 5 steps

**Make the dragon larger or smaller:**



Click this icon and then click a sprite to make it larger.



Click this icon and then click a sprite to make it smaller.



Don't forget to save your work



## ESCAPE THE DRAGON!

### Add a delicious donut

Scratch comes with lots of sprites in its library. Make the game trickier by adding a donut sprite to the program for the cat to chase.

- 16** Click the button above the sprite list to add a new sprite from the library. Select “Donut” from the “Things” category on the left and click “OK.”

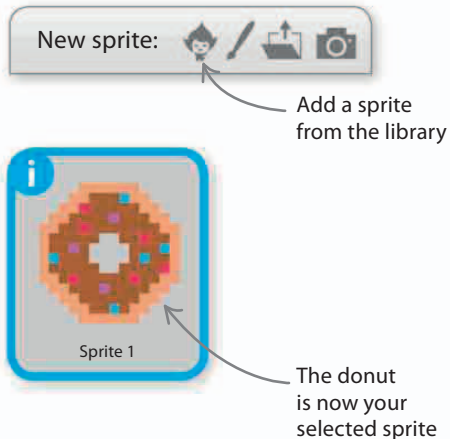

- 18** Select the cat in the sprite list so its script appears. Click the menu in the “point toward mouse-pointer” block. Change it so that the cat follows the donut instead of the mouse-pointer.

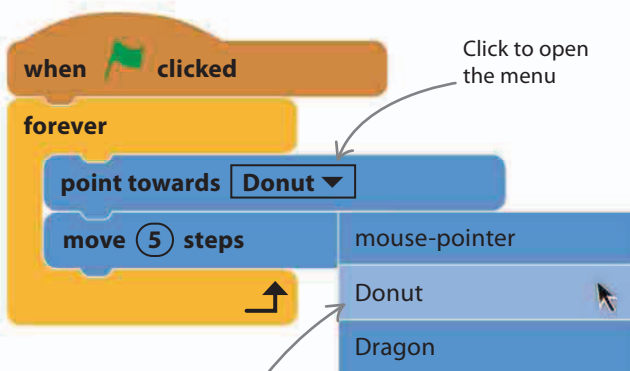

- 17** Add this script to the donut. The “mouse down?” block can be found in the “Sensing” section, and the “go to mouse-pointer” block in the “Motion” section. This script makes the donut follow the mouse-pointer when the mouse button is clicked.

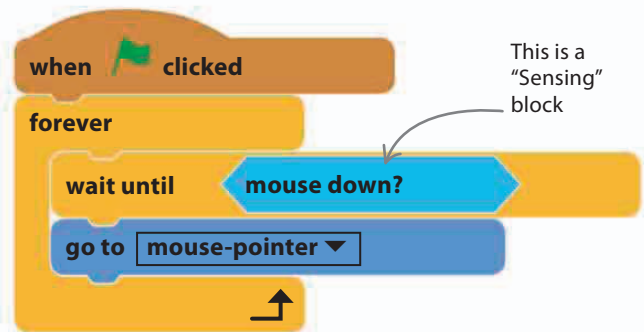

- 19** Click the green flag button to run the program. Press the mouse button and the donut moves to the mouse-pointer. The cat follows the donut, and the dragon chases the cat.

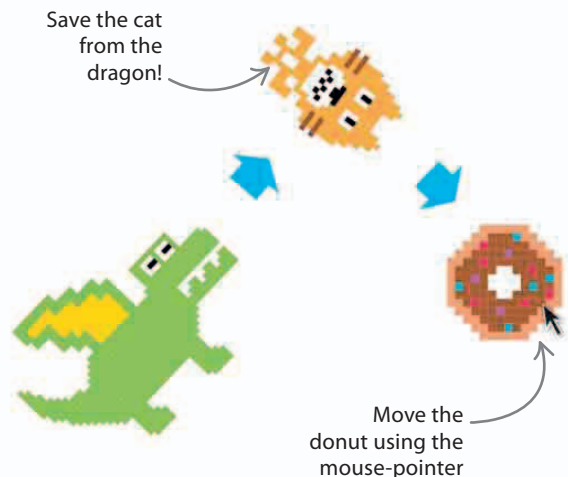

**20** Now add some music. Click the “Sounds” tab above the blocks palette. Each sprite has its own sounds, and they are managed here. Click the button on the left to add a sound from the library.

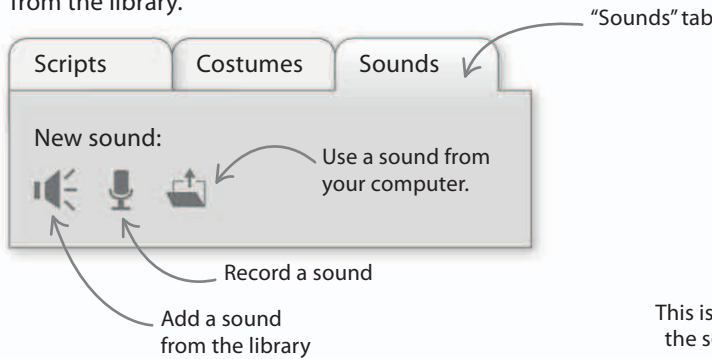

**21** Select the “drip drop” sound and click the “OK” button at the bottom-right. The sound is added to the cat sprite, and appears in the “Sounds” area.

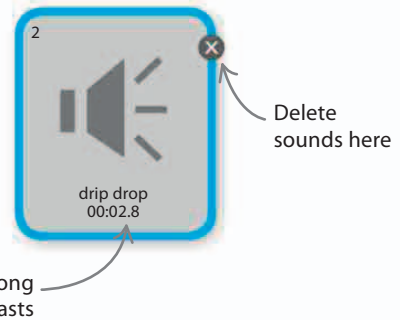

**22** Click the “Scripts” tab to go back to the scripts area. Add this script to the cat sprite, so it plays the music all the time. Run the program and have fun!

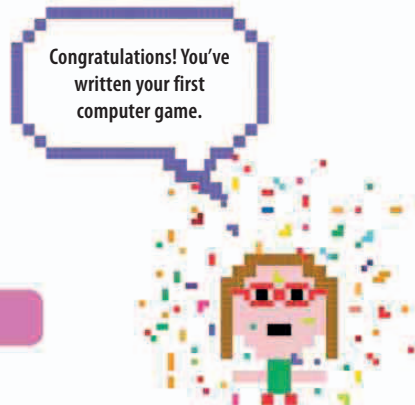
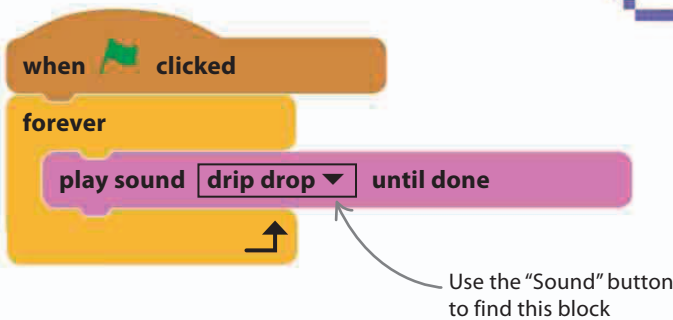

**REMEMBER**

**Achievements**

This project has shown some of the things Scratch can do. Here's what you've achieved.

**Created a program:** By combining blocks of code into scripts, you've put together a game.

**Added pictures:** You've used both backdrops and sprites.

**Made sprites move:** You've made sprites chase each other.

**Used a variable:** You've created a timer for your game.

**Used costumes:** You've changed the dragon's appearance using different costumes.

**Added music:** You've added a sound, and made it play when your program runs.

# Making things move

Computer games are all about firing, dodging, catching, and escaping. Characters might run, fly spaceships, or drive fast cars. To create great games in Scratch, you first need to learn how to make sprites move.

## SEE ALSO

◀ 28–29 Sprites

Co-ordinates 56–57 ▶

## Motion blocks

The dark blue “Motion” blocks make sprites move. Start a new project by clicking the “File” menu and choosing “New.” The new project begins with the cat in the middle of the stage, ready for action.

Scratch won't let sprites walk off the stage, so you'll never lose us.



### 1 First steps

Drag the “move 10 steps” block from the “Motion” section of the blocks palette and drop it into the scripts area to its right. Each time you click the block, the cat moves.

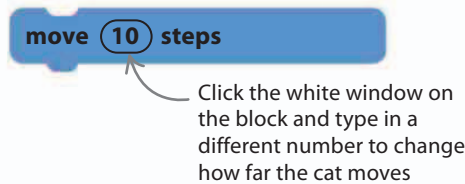

Add this block to tell Scratch when to start running the script

The “forever” block repeats anything inside it endlessly

### 2 Keep on moving

Drag a yellow “forever” block from the blocks palette and drop it around the “move 10 steps” block. Click the green flag on the stage to run the program. The cat moves until it hits the edge of the stage.

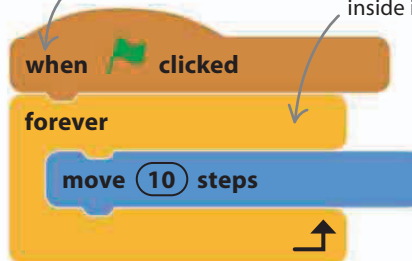

Try changing 10 to 30 to make the cat sprint!

### 3 Bouncing

Drag an “if on edge, bounce” block inside your “forever” block. Now the cat bounces when it hits the edge of the stage. The cat is upside down when it walks to the left.

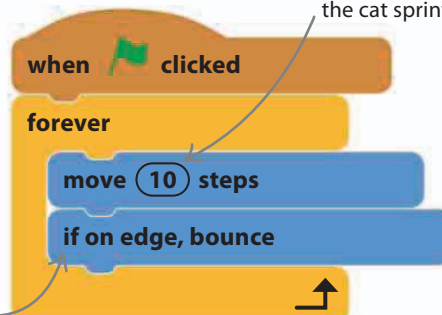



This block makes the cat turn around when it hits the edge of the stage

## EXPERT TIPS

### Rotation styles

Find the cat in the “Sprites” list in the bottom left of the screen. Click the “i” button in the top left of the frame. Here you’ll find a button to change the cat’s rotation style—so it doesn’t walk around on its head!

 The cat faces the direction it’s walking in, sometimes upside down.

 The cat faces left or right, and is always the right way up.

 The cat doesn’t rotate at all.



## Which direction?

The cat is now marching left and right across the screen. It's possible to change the cat's direction, so it walks up and down, or even diagonally. The "Motion" blocks can be used to make a game of cat and mouse.

The direction -90° means "left"

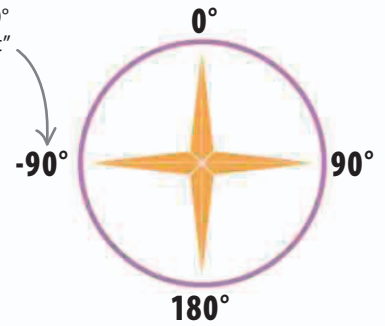

### △ Compass

Directions are measured in degrees, from 0° at the top. You can use any number between -179° and +180°.

### 4 Heading the right way

Drag the "point in direction" block into the scripts area and open its drop-down menu. There are four directions to choose from. Or, click on the number in the window and type in a new direction.

Click the block to make the cat change direction

Select or type in a new number to change the direction of the cat

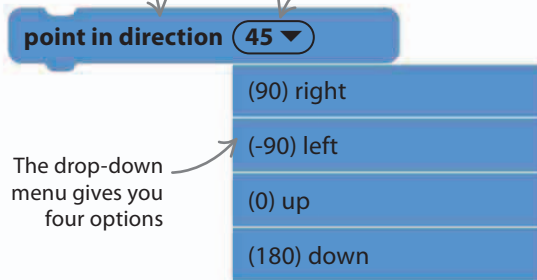

The drop-down menu gives you four options

The cat will follow the mouse-pointer

### 5 Cat and mouse

Remove the "move 10 steps" and "if on edge, bounce" blocks from the script. Now drag a "point towards" block into the "forever" block. Open the menu and choose "mouse-pointer."

Click the green flag to start the program

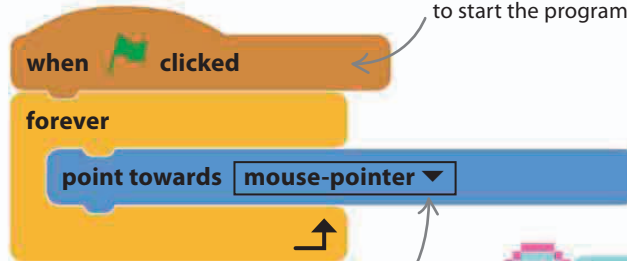

As the mouse-pointer moves, the cat turns to face it

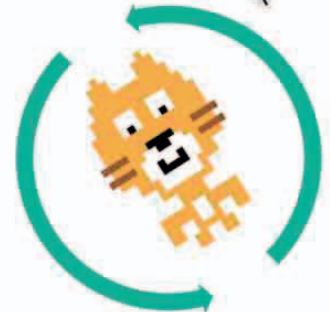

### 6 Chase the mouse

Can the cat catch the mouse? Drag a "move 10 steps" block into the "forever" loop. Now the cat walks toward the mouse-pointer.

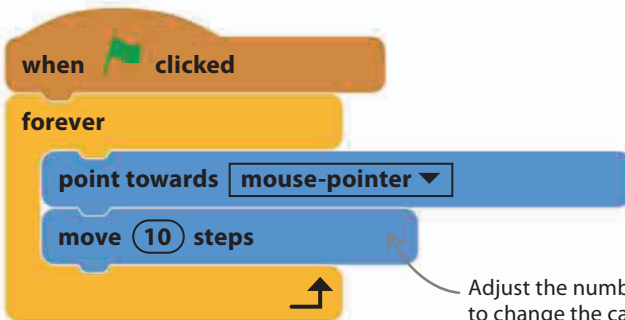

Adjust the number of steps to change the cat's speed

**REMEMBER**

## Sprites

Sprites are objects in a Scratch program that you can move around (see pp.28–29). Every new project starts the cat sprite, but you can add cars, dinosaurs, dancers, and all sorts of other sprites from the library. You can even have a go at designing your own.

# Costumes

To change what a sprite looks like, its expression, or its position, you need to change its “costume.” Costumes are pictures of a sprite in different poses.

## SEE ALSO

◀ **38–39** Making things move

Sending **70–71** ▶ messages

## Changing costumes

Different costumes can make your sprite look like it’s moving its arms and legs. When you switch between the cat’s two costumes, it looks like it’s walking. Start a new project and try this example.

### 1 Different costumes

Click the “Costumes” tab to see the cat’s costumes. They show the cat with its legs and arms in two different positions.

### 2 Make the cat walk

Add this script to make the cat walk. When it moves, it slides across the screen without moving its legs, because its picture always stays the same.

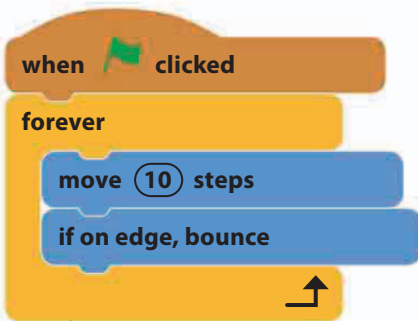

The colors remind you where to find the blocks

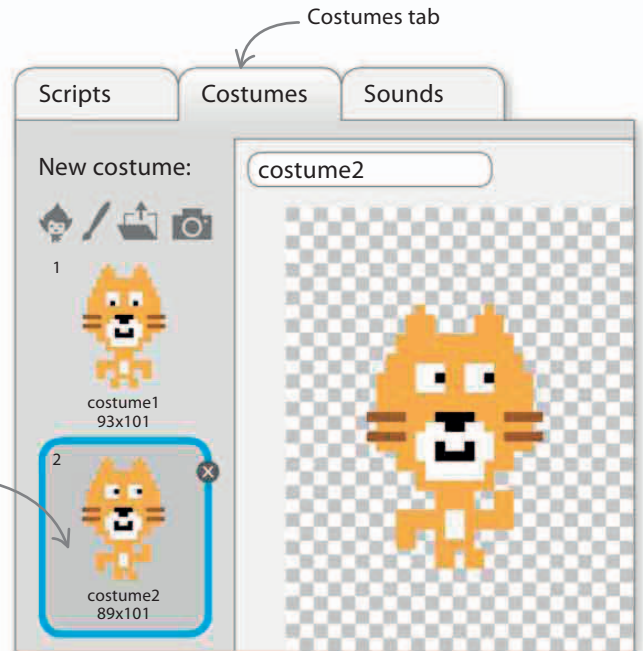

### 3 Change the cat's costume

Add the “next costume” block from the “Looks” section of the blocks palette, so the cat changes its costume with each step. This makes its legs and arms move.

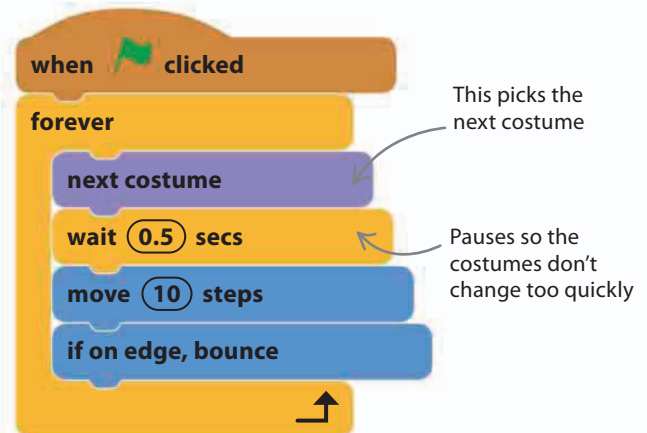

This picks the next costume

Pauses so the costumes don't change too quickly

## Dancing ballerina

Now try making a ballerina dance. Add the ballerina sprite from the library. Select your cat in the sprite list and drag its script on to the ballerina in the sprite list. This copies the script to the ballerina.

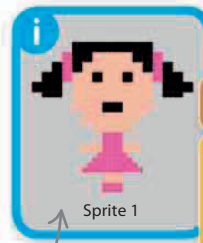

Drop the script on to the ballerina in the sprite list

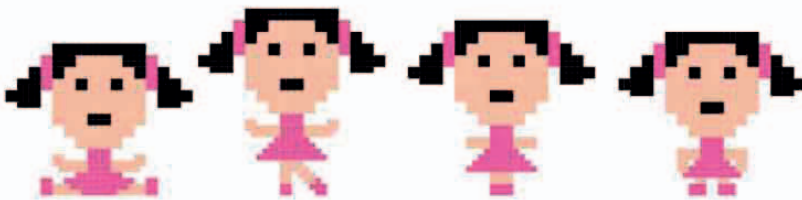

The green flag starts the ballerina's dance

### △ Ballerina's script

The same script works for the ballerina and the cat. The ballerina has four costumes, and she uses them all as she dances on the stage.

## EXPERT TIPS

### Switching

You can choose to show a specific costume for your sprite using the "switch costume to" block. You can use this block to choose a particular position for your sprite.

switch costume to ballerina-a ▼

**Switch costumes:** Use the menu in the block to choose a costume.

switch backdrop to backdrop1 ▼

**Switch backdrops:** Change the picture on the stage with this block.

## Adding speech bubbles

You can add speech bubbles to make your sprites talk when they change costumes. Use the "say Hello! for 2 secs" block and change the text in it to make your sprite say something else.

The ballerina says "Up!"

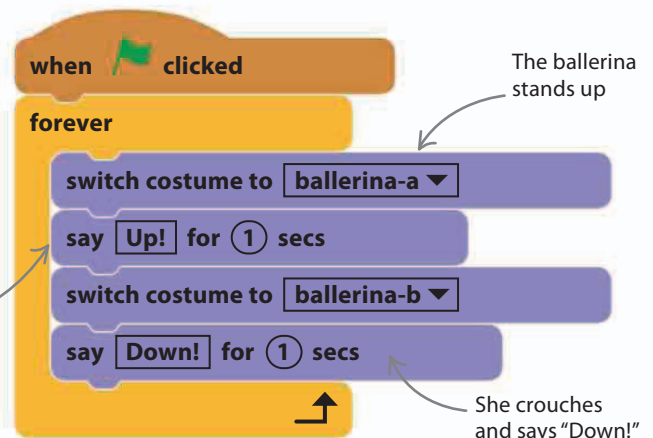

The ballerina stands up

She crouches and says "Down!"

# Hide and seek

Welcome to the special effects studio! Using the purple “Looks” blocks, find out how to make sprites vanish and reappear, grow and shrink, and fade in and out.

## Hiding sprites

To make a sprite disappear, use the “hide” block. The sprite is still on the stage, and it can still move around, but it can’t be seen unless the “show” block is used to make it visible again.

### ▷ Hide and show

To make a sprite vanish, use the “hide” block. When you’re ready for it to be seen again, use the “show” block. These blocks are found in the “Looks” section of the blocks palette.

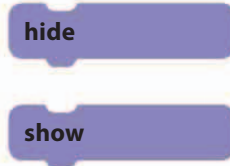

### ▽ Disappearing cat

Try this script using the cat sprite. It disappears and reappears but it keeps moving, even when you can’t see it.

 A Scratch script starting with a 'when green flag clicked' block. It is followed by a 'forever' loop containing:
 

- 'wait 1 secs' block
- 'hide' block (with an arrow pointing to it from the text 'This block hides the cat')
- 'turn 90 degrees' block (with an arrow pointing to it from the text 'This block rotates the cat clockwise')
- 'move 100 steps' block (with an arrow pointing to it from the text 'The cat still moves even when hidden')
- 'wait 1 secs' block
- 'show' block (with an arrow pointing to it from the text 'This block shows the cat again')

### SEE ALSO

◀ 38–39 Making things move

Sending 70–71 ▶ messages

Use the “hide” block to make sprites disappear in games

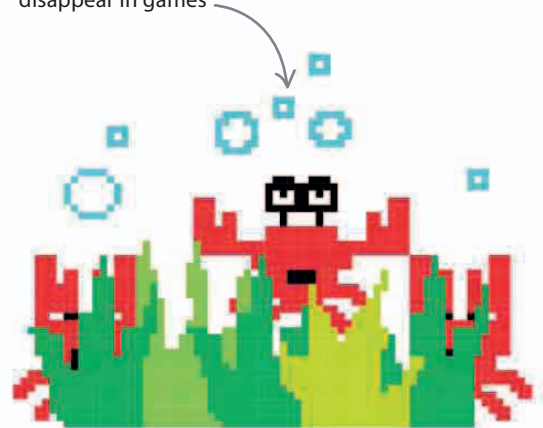

### EXPERT TIPS

## Showing sprites

Select a sprite in the sprite list. Click the “i” button on it to open the information panel. There you can also use the “show” tick box to show or hide a sprite.

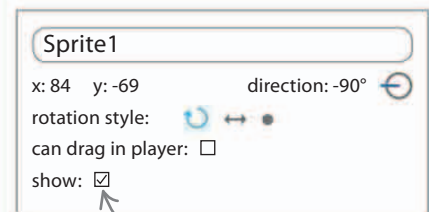

Show a hidden sprite

## Sizes and effects

Scripts can be used to change the size of a sprite and add special effects to it.



### △ Changing a sprite's size

These two blocks can be used to make a sprite bigger or smaller, either by a set amount or by a percentage of its size.

Choose the type of effect from the drop-down menu. The "pixelate" effect makes the sprite become blurred

Change the numbers in the blocks to set how strong the effect is



Each color is represented by a number. Change the number to set the color



Resets all the effects

### △ Adding graphic effects

The graphic effects in Scratch can be used to change a sprite's appearance or distort its shape. They're fun to experiment with.

## Using effects to teleport

Add a ghost sprite from the "Fantasy" category of the sprite library, and create the script shown below. It makes the ghost appear to teleport when clicked.

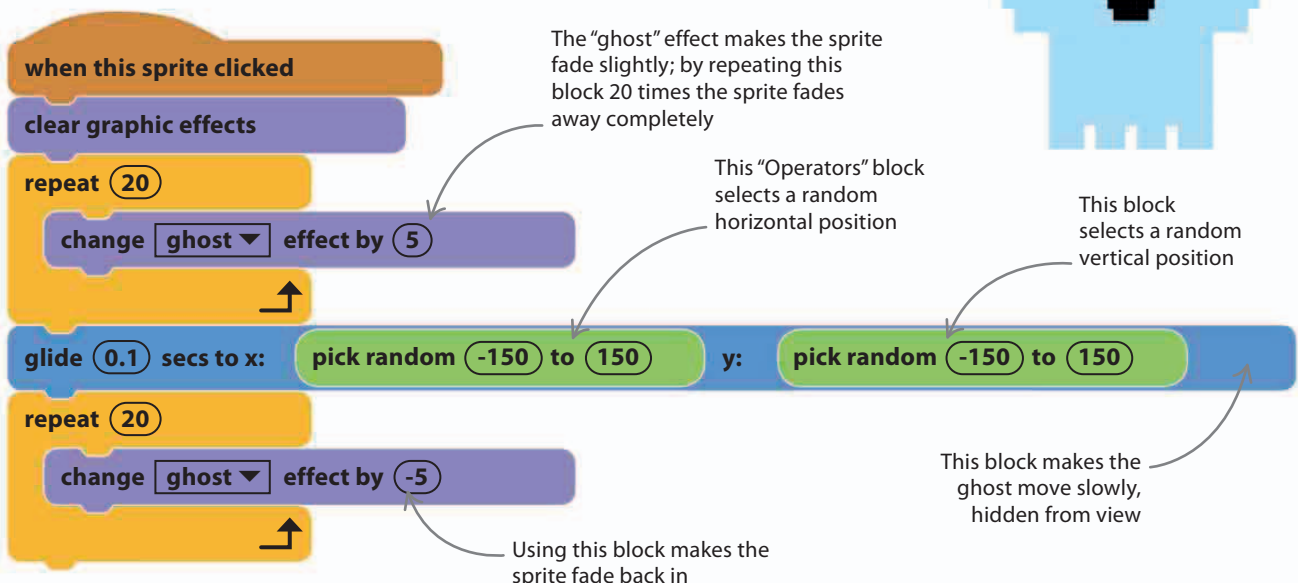

# Events

The brown “Events” blocks in Scratch start scripts when certain things happen. For example, when the user presses a key, clicks a sprite, or uses a webcam or microphone.

## Clicking

A script can be added to a sprite that makes it do something if the sprite is clicked while the program is running. Experiment with different blocks to see what a sprite can do when clicked.



### △ Click a sprite

This script makes the cat sprite meow when you click it.

Drag this block from the “Events” menu to start the script

The cat sprite already has this sound effect attached to it

## Key presses

Programs can be built to react when different keys on the keyboard are pressed. For another way of using the keyboard that’s better for creating games, see pages 66–67.

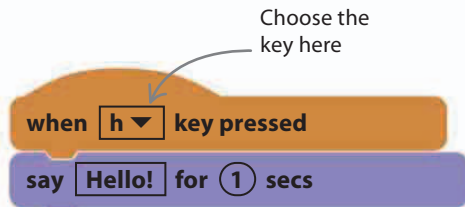

### △ Say hello

Add this script to a sprite and when the H key is pressed, the sprite says “Hello!”

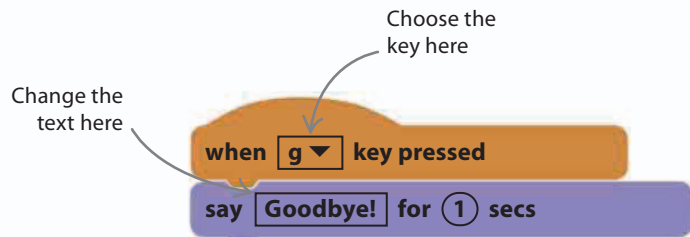

### △ Say goodbye

This script uses the G key to make a sprite say “Goodbye!”

## SEE ALSO

Sensing **66–67** >  
and detecting

Sending **70–71** >  
messages

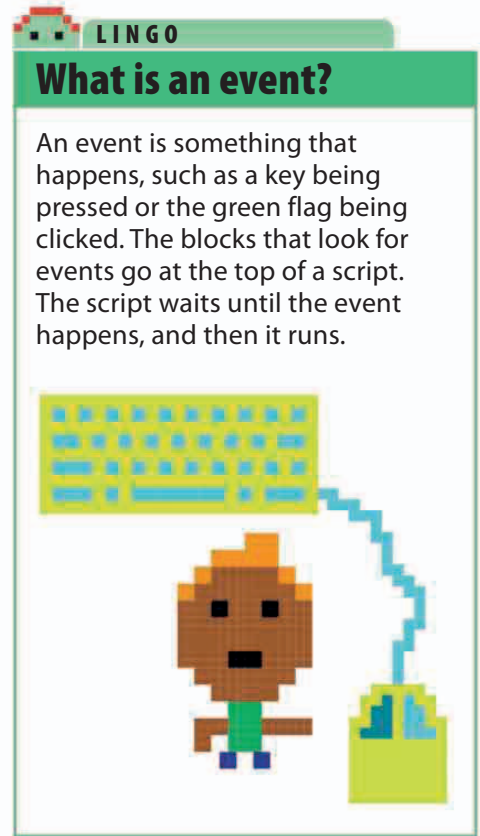

## Sound events

If your computer has a microphone, sprites can detect how loud the sounds in a room are on a scale of 0 (very quiet) to 100 (very loud). Use the “when loudness > 10” block to make a script start when the sounds are loud enough.



### EXPERT TIPS

#### Asking permission

Scratch asks for permission to use your webcam and microphone. When the box pops up, click “Allow.”

- 1 Make the cat sensitive to noise**  
Start a new project, and add the “room3” backdrop image from the backdrop library. Drag the cat sprite on to the chair and add the script shown here.

- 2 Shout at the cat**  
Shout into the microphone—the cat will jump out of its seat with fright and meow. It will also respond to music and other sounds if they are loud enough.

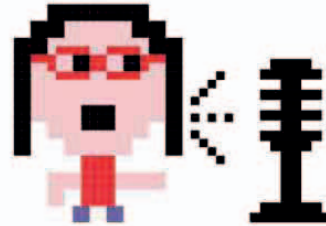
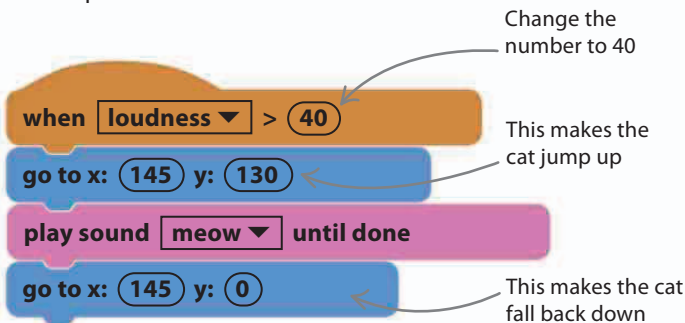

## Webcam motion detector

If you have a webcam, it can be used with Scratch too. Add this script to the cat, and when you wave at it through the webcam, it will meow back.

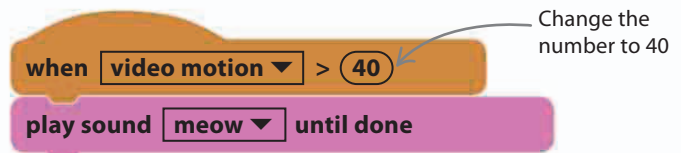

### △ Detect motion

Use the “when loudness > 10” block. Click the menu to change “loudness” to “video motion.” The script will start when you’re moving around enough.



### EXPERT TIPS

#### Backdrop changes

A sprite can react to the backdrop changing. For example, you can have a backdrop that makes the sprite disappear. Upload a new backdrop from the stage list in the bottom left of the screen, and then add the “when backdrop switches to backdrop1” block to do this.

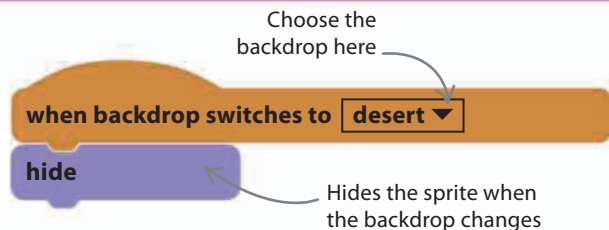

# Simple loops

A loop is a part of a program that repeats itself. The loop blocks (from the “Control” section) tell Scratch which blocks to repeat, and how many times. They save us from adding the same blocks over and over again.

## SEE ALSO

Complex **68–69** >  
loops

Loops **122–123** >  
in Python

## Forever loop

Whatever you put inside the “forever” block repeats itself forever. There’s no option to join anything at the bottom, because a “forever” loop never ends.

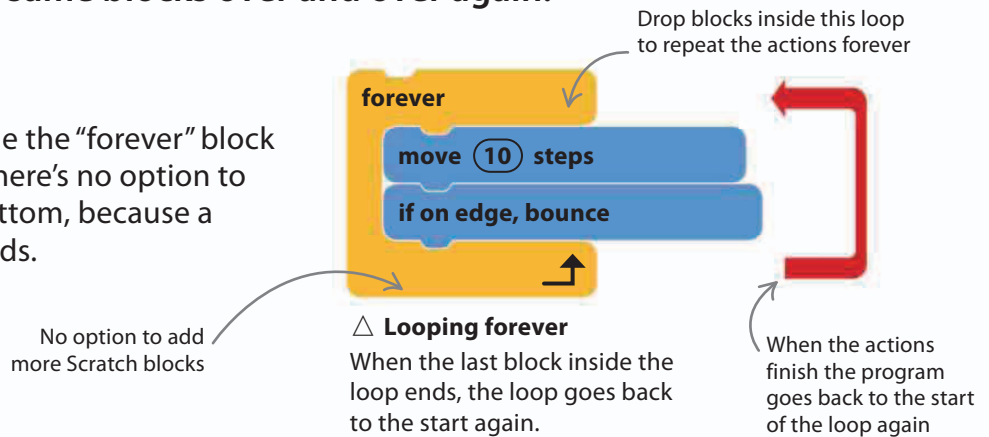

## Repeat loop

To repeat an action a certain number of times, use a “repeat 10” block. Change the number in it to set how many times the loop will repeat itself. Add the “Dinosaur1” sprite to a new project and build it this script.

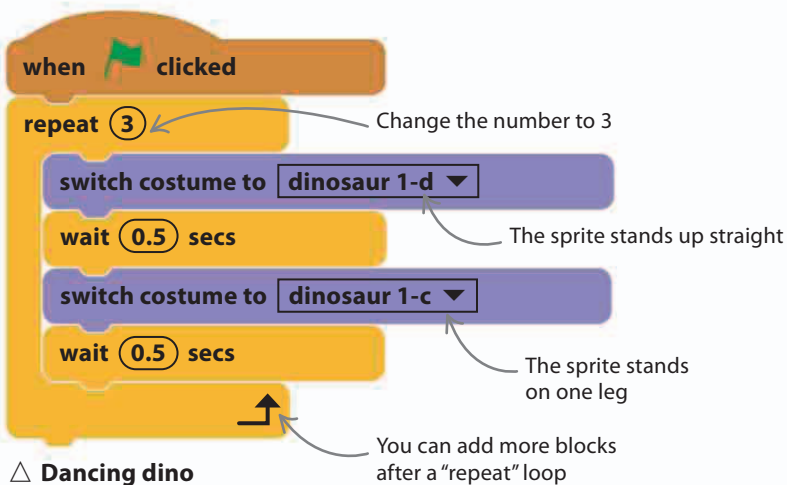

### △ Dancing dino

When the green flag is clicked, the dinosaur dances. He repeats his dance moves three times.

## REMEMBER

### Loop block shape

The loop blocks are shaped like jaws. Drop the blocks that you want to repeat into the jaws, so the loop wraps around them. As you add more blocks, the jaws stretch to make room for them.

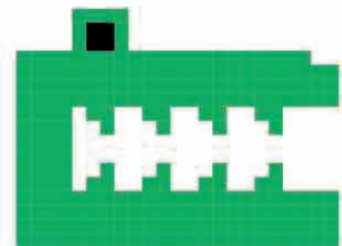



## Nested loops

Loops can also be “nested,” which means they can be put inside each other. In this script, the dinosaur finishes his dance by walking right and left and then thinking for a moment. When he’s got his breath back, he dances again and stops only when you click the red stop button.

### ▷ Loops in loops

This “forever” loop has several repeat loops inside it. Make sure the blocks are inside the right loops, otherwise the program won’t work properly.

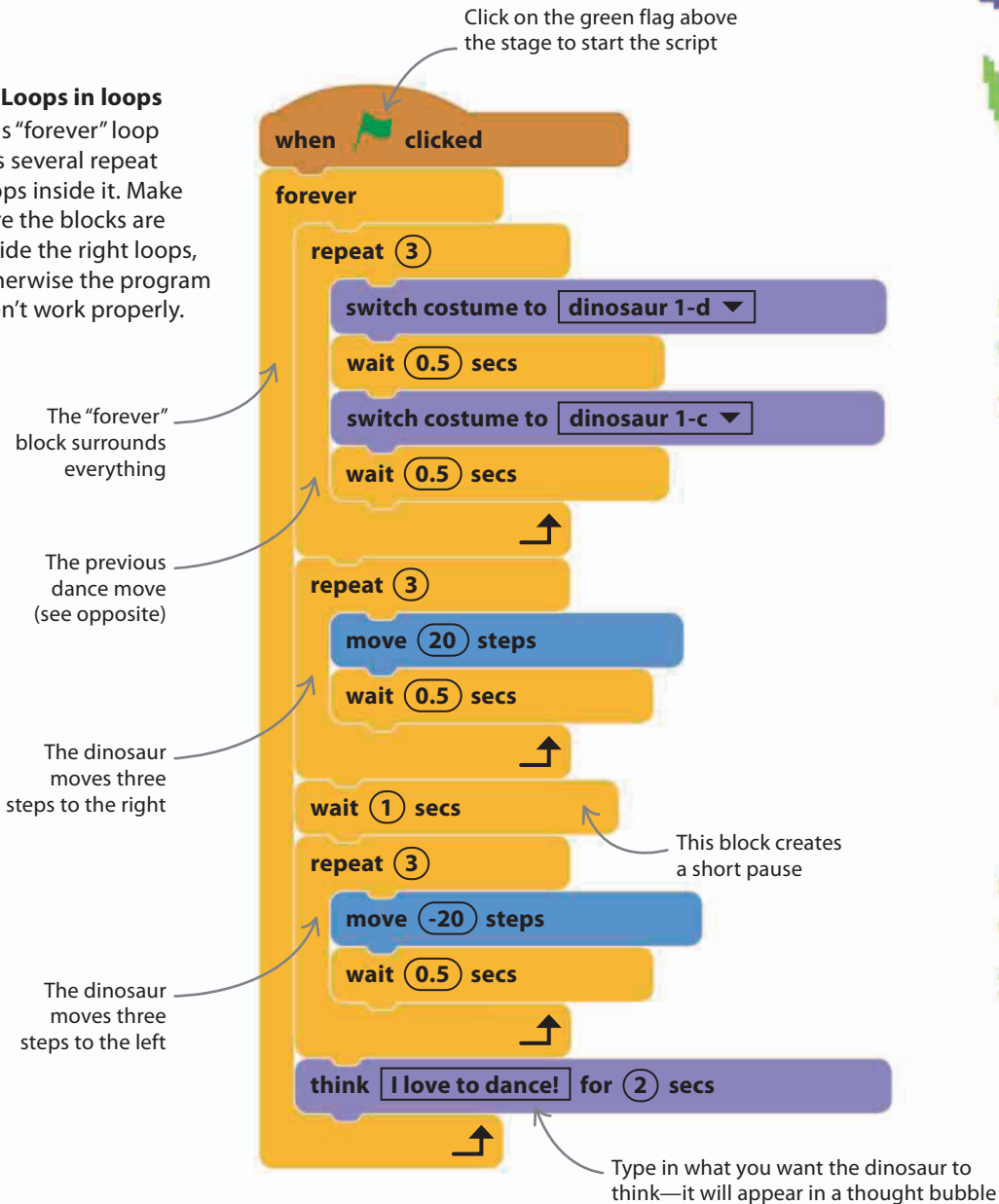

# Pens and turtles

Each sprite has a pen tool that can draw a line behind it wherever it goes. To create a picture, turn on the pen and then move the sprite across the stage, like moving a pen across paper.

## SEE ALSO

< 44–45 Events

< 46–47 Simple loops

## Pen blocks

The dark green blocks are used to control the pen. Each sprite has its own pen that can be turned on by using the “pen down” block and turned off using the “pen up” block. The size and color of the pen can also be changed.

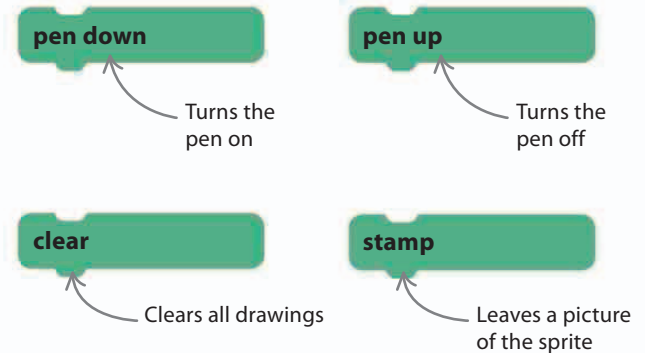

### △ Playing with pens

Experiment with how you can use the pen blocks to make drawings.

## Draw a square

To draw a square, you simply put the pen down on the stage and then move the sprite in a square shape. Use a loop to draw the four sides and turn the corners.

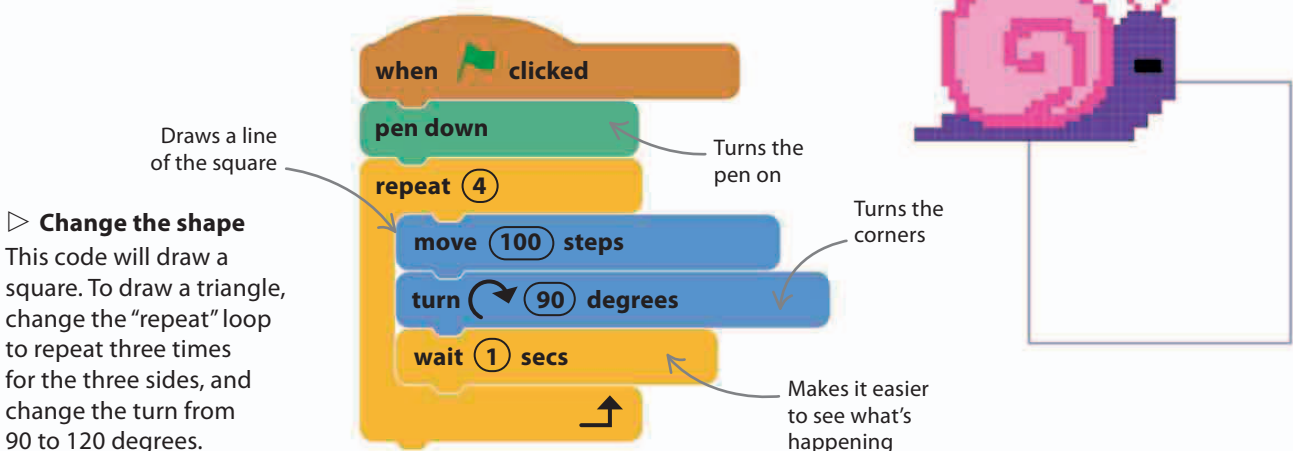

### ▷ Change the shape

This code will draw a square. To draw a triangle, change the “repeat” loop to repeat three times for the three sides, and change the turn from 90 to 120 degrees.

# Skywriting

In this program, you control a plane. As you fly it will leave a smoke trail, so you can draw in the sky. Start a new project and add the plane sprite, then add this script.

## ▷ Flying high

Use the left and right keys to turn the plane. Switch on the smoke with the “a” key and turn it off with the “z” key. Press the spacebar to clear the sky.

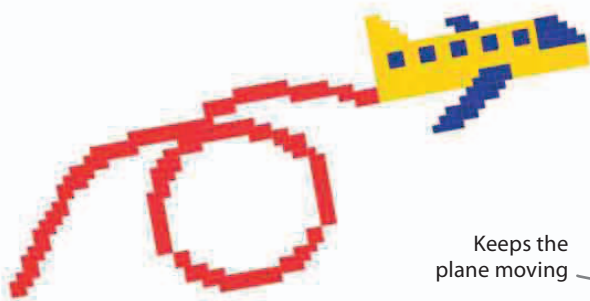

You can only use colors that appear on the Scratch interface. To select red, click in the square and then click on the red stop button above the stage

```

when clicked
  set size to 20 %
  set pen color to [red]
  set pen size to 3
  forever
    move 2 steps
    if on edge, bounce
  
```

Keeps the plane moving

Makes the line thicker

Keeps the plane on the stage

**LINGO**

## Turtle graphics

Using sprites to draw pictures is called “turtle graphics.” That’s because there’s a type of robot called a turtle that can be moved around the floor to draw pictures. The first programming language to use turtle graphics was called LOGO.

```

when right arrow key pressed
  turn 10 degrees
when left arrow key pressed
  turn -10 degrees
when a key pressed
  pen down
when z key pressed
  pen up
when space key pressed
  clear
  
```

Rotates right

Rotates left

Turns the pen on

Turns the pen off

Clears the pen trail

# Variables

In coding, a variable is the name for a place where you can store information. Variables are used to remember things such as the score, a player's name, or a character's speed.

## Creating a variable

You can create a variable to use in your program using the "Data" section of the blocks palette. Once a variable has been created, new blocks appear in the blocks palette ready for you to use.

### SEE ALSO

Maths **52-53** >

Variables **108-109** >  
in Python



### ◀ Storing data

Variables are like boxes where you can store different bits of information for use in your program.

### 1 Make a variable

First, click the "Data" button in the blocks palette. Then select the "Make a Variable" button.

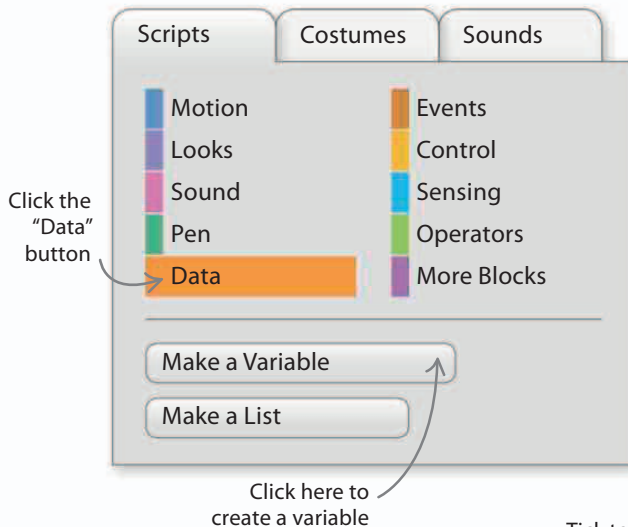

### 2 Name the new variable

Give the variable a name that will help you to remember what it does. Select which sprites will use the variable, then click "OK."

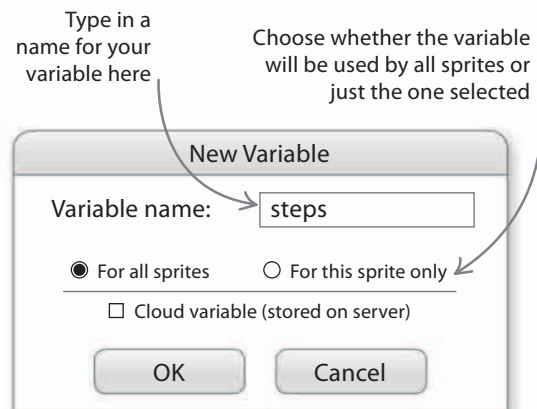

### 3 A new variable is created

Once a new variable has been created, new blocks appear in the blocks palette. The menus inside these blocks let you select which variable they apply to, if you have created more than one.

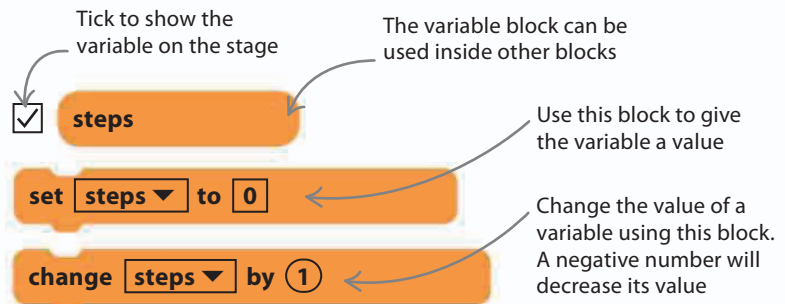

## Using a variable

Variables can be used to change a sprite's speed. This simple script shows you how.

- 1 Set the value of a variable**  
Create this script. Use the "set steps to 0" block and change the number to 5. Drag the "move 10 steps" block into the script, but drop the "steps" variable block over the "10."

This sets the value of the "steps" variable to 5

Here, "steps" means 5, as the value has been set above

Set my speed using the "set steps to 0" block.

The script consists of the following blocks:

- when green flag clicked
- set steps to 5
- forever loop containing:
  - move steps steps
  - if on edge, bounce

A cat sprite is shown below the script, with a speech bubble indicating its speed is being set.

- 2 Changing the value of a variable**  
Use the "change steps by 1" block to increase the value of the variable "steps" by 1. Put it inside the "forever" block, so the cat keeps on getting faster.

The "steps" variable keeps on increasing as the "forever" loop goes around and around

The script consists of the following blocks:

- when green flag clicked
- set steps to 0
- forever loop containing:
  - change steps by 1
  - move steps steps
  - if on edge, bounce

A cat sprite is shown below the script, with a speech bubble indicating its speed is being increased.

## Deleting variables

When you no longer want a variable, right-click on it in the blocks palette and then select "delete variable." You'll lose any information that was in it.

Variables can be renamed here

The screenshot shows the "steps" variable selected in the blocks palette. A context menu is open with the following options:

- Make a Variable
- Make a List
- steps (checked)
- rename variable
- delete variable

## EXPERT TIPS

### Read-only variables

Some variables are set by Scratch and can't be changed. They're still variables, though, because their values vary. These blocks are known as sensing blocks.

**distance to**

Tracks the distance to something, such as the mouse-pointer.

**costume #**

Reports the number of the costume a sprite is wearing.

**direction**

Tells you which direction a sprite is travelling in.

# Math

As well as storing numbers in variables (see pp.50–51), Scratch can be used to carry out all sorts of calculations using the “Operator” blocks.

## SEE ALSO

◀ 50–51 Variables

Math 112–113 ▶  
in Python

## Doing sums

There are four “Operator” blocks that can be used to do simple calculations. These are addition, subtraction, multiplication, and division.

$$7 + 22$$

### △ Addition

The “+” block adds the two numbers in the block together.

$$64 - 28$$

### △ Subtraction

The “-” block subtracts the second number from the first.

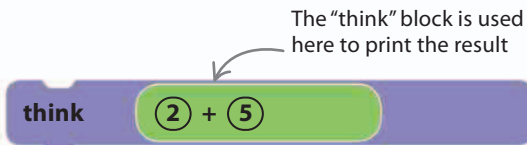

### △ Printing results

Drag a “think” block into the scripts area and drop a “+” block inside it. Now add two numbers together and watch your sprite think the answer.

$$11 * 10$$

### △ Multiplication

Computers use the “\*” symbol for multiplication, because “x” looks like a letter.

$$120 / 4$$

### △ Division

There’s no division sign on the keyboard, so Scratch uses the “/” symbol instead.

## Results in a variable

For more complex calculations, such as fixing the sale price of an item, instead of just using numbers you can use the value of a variable in a sum. The result can be stored in a variable too.

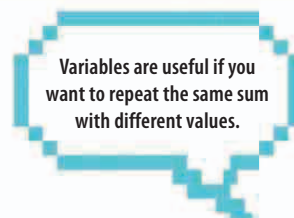

- 1 Create variables**  
Go to the “Data” section of the blocks palette and create two variables—“sale price” and “price”.

- 2 Set the price**  
Select the “set price” block and fix the price of an item to 50.

set **price** ▼ to 50

Use the drop-down menu to select “price”

- 3 Calculate the sale price**  
Use this script to calculate half the price of an item and set it as the sale price.

set **sale price** ▼ to

**price**

/ 2

Drag the “price” variable into the window to divide the price by 2

Add the “/” block inside the “set sale price” block

## Random numbers

The “pick random” block can be used to select a random number between two values. This block is useful for rolling dice in a game or for when you want to mix up a sprite’s costumes.

pick random 1 to 10

You can change the numbers in the block

### Pick a random number

To pick a random month, change the numbers to choose a number between 1 and 12.

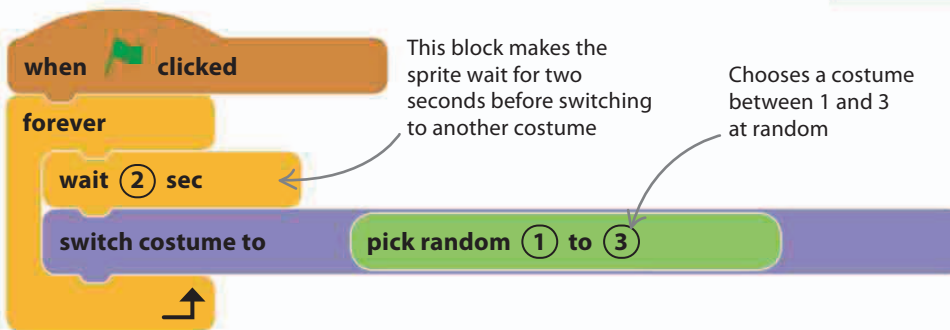

### Switching costumes

This script changes a sprite’s costume at random every two seconds.

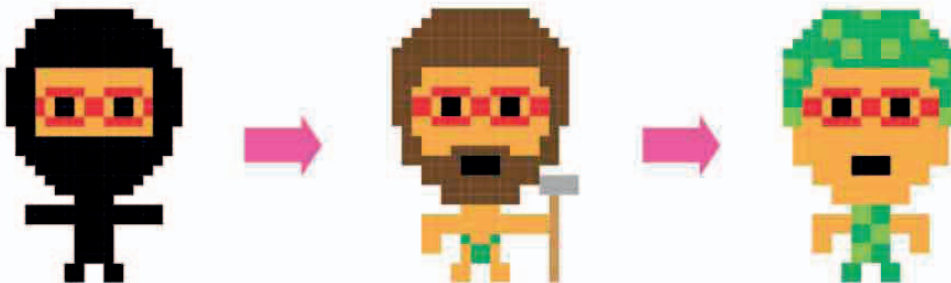

### Random costumes

Costumes can make a sprite appear to move its body, or might give it different clothes, as shown here.

## Hard math

Simple “Operator” blocks can do most calculations, but Scratch can also do more complex math. The “mod” block divides two numbers and gives the remainder, which is the number that is left over. The “round” block rounds to the nearest whole number, and the “sqrt” block gives the square root of a number.

10 mod 3

Gives nearest whole number to 44.7

Divides 10 by 3 and gives the remainder—the number that is left over

round 44.7

Choose different functions from the drop-down menu

### More math

The “Operator” section has blocks of advanced math functions that can be used to do complex calculations.

sqrt of 9

Calculates the square root of 9

# Strings and lists

In programming, a sequence of letters and symbols is called a “string”. Strings can contain any character on the keyboard (including spaces) and be of any length. Strings can also be grouped together in lists.

## SEE ALSO

◀ 50–51 Variables

Strings 114–115 ▶  
in Python

Keyboard characters are lined up as if they were hanging from a string

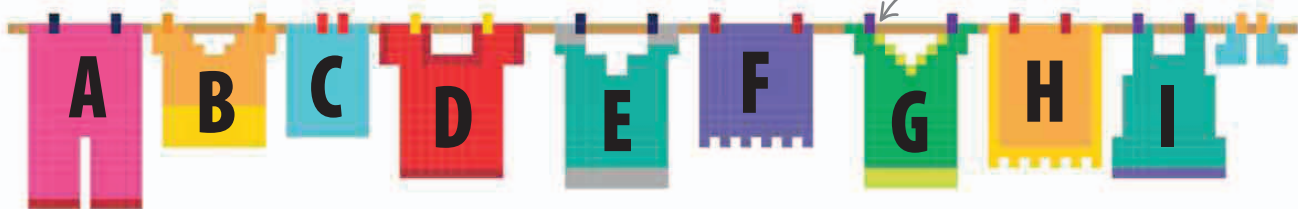

## Working with words

Programs often need to remember words, such as a player’s name. Variables can be created to remember these words. Scratch programs can also ask the user questions, which they answer by typing into a text box that pops up. The following script asks for the user’s name, and then makes a sprite say “Hello” to them.

### 1 Create a new variable

Click the “Data” button in the blocks palette and click the “Make a Variable” button. Create a variable called “greeting”.



Name your variable “greeting”

This block puts “Hello ” into the variable “greeting”. Leave a space at the end of “Hello ” to make the output of the program neater

### 2 Asking a question

This script makes the sprite ask a question. Whatever the user types into the text box that pops up on the screen is stored in a new variable called “answer”. The script then combines the strings contained in the “greeting” and “answer” variables to greet to the user.

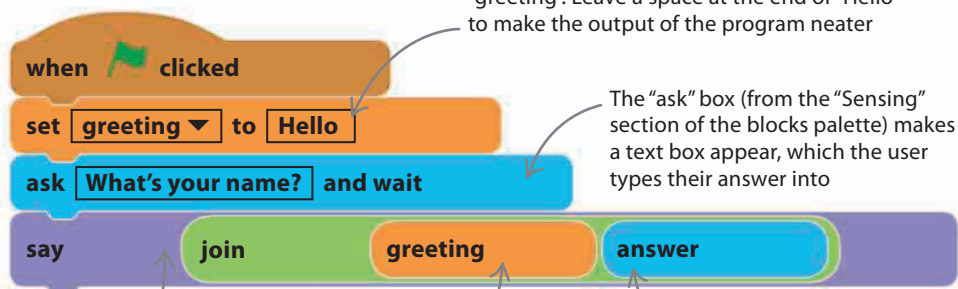

The “say” bubble creates a speech bubble for the sprite

The “greeting” variable holds the string “Hello ”

The “answer” variable (from the “Sensing” section) contains whatever the user types into the text box



# Making lists

Variables are perfect if you just want to remember one thing. To remember lots of similar things, lists can be used instead. Lists can store many items of data (numbers and strings) at the same time—for example, all of the high scores in a game. The following program shows one way of using a list.

**1 Create a list**  
 Start a new project. Go into the “Data” section of the blocks palette and click the “Make a List” button. Give your list the name “sentence”.

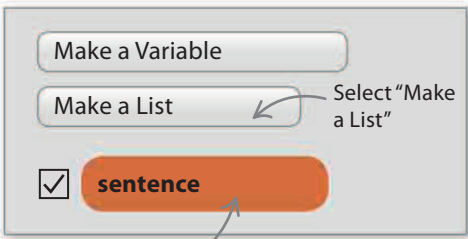

Select “Make a List”  
 Call your list “sentence”  
 This adds the user’s answer to the list

**2 Using your list**  
 This script asks the user to type words into a list. Each word appears in the sprite’s speech bubble as it is added to the list.

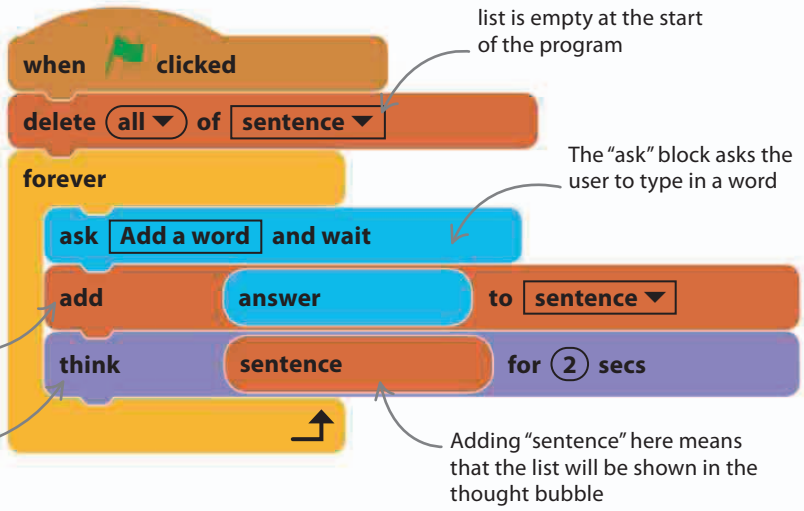

**3 Seeing the list**  
 If you check the box beside the list in the blocks palette, the list is shown on the stage. You can see each new word as it’s added to the list.

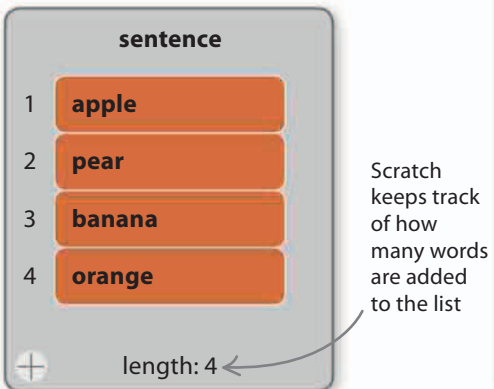

### EXPERT TIPS

## Playing with lists

These blocks can be used to change the contents of a list. Each item in a list has a number—the first item is number 1, and so on. These numbers can be used to remove, insert, or replace items.

Deletes the first item in the list  
 Adds “cherry” as the first item in the list  
 Replaces the first list item with “cherry”

# Coordinates

To put a sprite in a particular spot, or to find out its exact location, you can use coordinates. Coordinates are a pair of numbers that pinpoint a sprite's position on the stage using an x and y grid.

## x and y positions

The x and y positions of a sprite and the mouse-pointer are shown on the Scratch interface. It can be helpful to know a sprite's coordinates when writing a script.

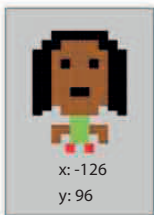

### ◀ Position of a sprite

You can see a sprite's current coordinates in the top right corner of the scripts area.

x: 240 y: 180

### △ Position of the mouse-pointer

The mouse-pointer's coordinates are shown at the bottom right of the stage. Move the mouse-pointer over the stage and watch the coordinates change.

**x position**

**y position**

### ◀ Show coordinates on the stage

Check the boxes beside the "x position" and "y position" blocks to show a sprite's position on the stage.

## x and y grid

To pinpoint a spot, count the number of steps left or right, and up or down, from the middle of the stage. Steps to the left or right are called "x". Steps up or down are called "y". Use negative numbers to move left and down.

The stage is based upon an x and y grid

This sprite is 190 steps left (-190) and 150 steps down (-150) from the middle of the stage

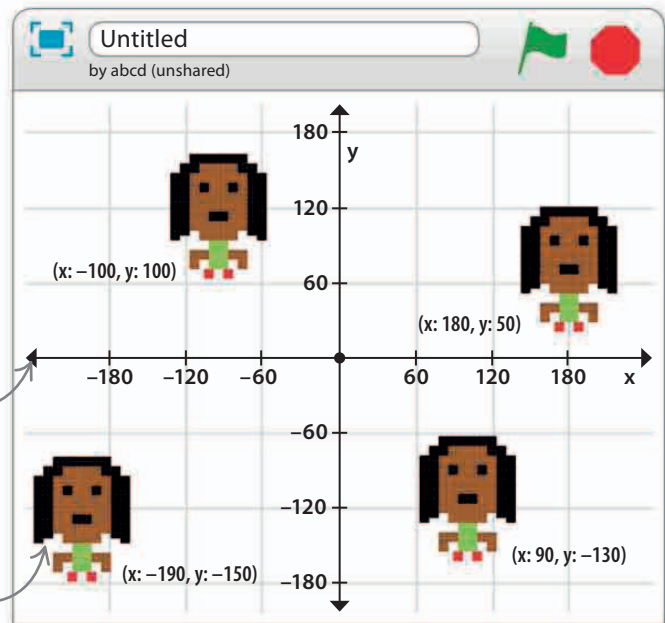

## Moving the sprite

Coordinates are used to move a sprite to a particular spot on the stage. It doesn't matter how near or far away the spot is. The "glide 1 secs to x:0 y:0" block from the "Motion" section of the blocks palette makes the sprite glide there smoothly.

when  clicked

glide 1 secs to x: 150 y: 100

glide 1 secs to x: -150 y: -100

glide 1 secs to x: -200 y: 100

glide 1 secs to x: 0 y: 0

Change the coordinate numbers to make the sprite go somewhere else

### △ Control the sprite with a script

Can you work out the path the sprite will take when you run this script? Try it and see!

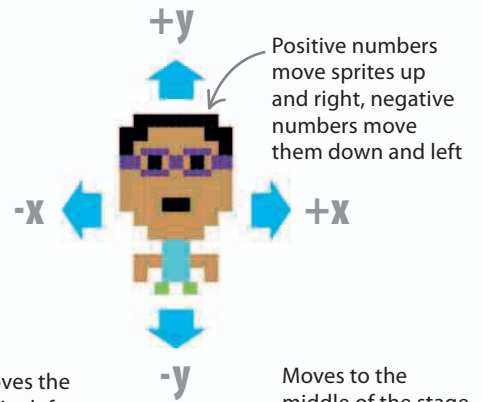

Moves the sprite left

change x by -10

set x to 0

Moves to the middle of the stage

change y by 125

set y to 180

### △ Change x and y separately

These blocks can be used to change x without changing y, and the other way around.

Moves up to the top of the stage

## Crazy horse's trip

Try this fun script to test out coordinates. Select the "Horse1" sprite from the sprite list and give it the below script. This program uses the "go to x:0 y:0" block to keep moving the horse to a random position, drawing a line behind it as it goes.

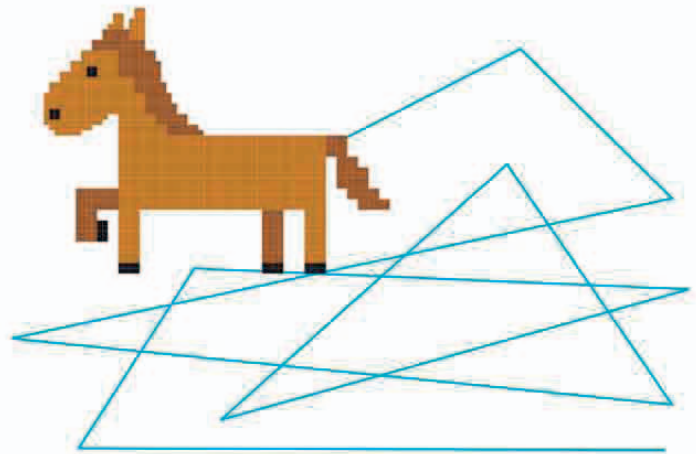

when  clicked

pen down

forever

go to x: pick random -240 to 240 y: pick random -180 to 180

wait 0.2 secs

This block leaves a line when the horse moves

This block from the "Operators" menu selects a random horizontal position

Selects a random vertical position

# Make some noise!

Scratch programs don't have to be silent. Use the pink "Sound" blocks to try out sound effects and create music. You can also use sound files you already have or record brand new sounds for your program.

## SEE ALSO

Sensing **66–67** >  
and detecting

Monkey **74–81** >  
mayhem

## Adding sounds to sprites

To play a sound, it must be added to a sprite. Each sprite has its own set of sounds. To control them, click the "Sounds" tab above the blocks palette.



Click here to select a sound effect from Scratch's library

Record a sound using the computer's microphone

Click the "Sounds" tab to show the sound option buttons



Upload a recording from the computer

## Playing a sound

There are two blocks that play sounds: "play sound" and "play sound until done." "Until done" makes the program wait until the sound has finished before it moves on.

Use the menu to choose which sound to play



The next block in the script will not run until after the meow sound has finished playing

## Turn up the volume

Each sprite has its own volume control, which is set using numbers. 0 is silent and 100 is the loudest.

100 is the maximum volume

set volume to **100** %

This block makes a sprite louder or quieter—use a negative number to make it quieter

change volume by **-10**

Ticking this box makes the sprite's volume show on the stage



volume

## Making your own music

Scratch has blocks that can be used to invent musical sounds. You have a whole orchestra of instruments to conduct, as well as a full drum kit. The length of each note is measured in beats.

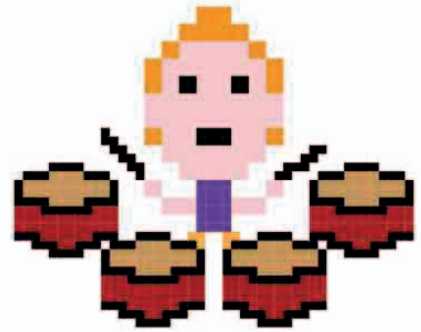

This decides how low or high the pitch of a note is

```
play note 60 for 0.5 beats
```

Big numbers make a note longer. It can also be shorter than a beat, as shown here

```
set instrument to 1
```

Click here to choose an instrument from a drop-down menu

```
play drum 1 for 0.25 beats
```

Use this menu to choose between different types of drum

```
rest for 0.25 beats
```

This block adds a silent break in the music. Higher numbers will give you a longer break

## Playing music

Connecting notes together makes a tune. Create a new variable called "note" (see pages 50–51), and then add the script below to any sprite to create a piece of music.

```
when clicked
  set note to 1
  set instrument to 1
  forever
    change note by 1
    play note note for 0.5 beats
```

Set the value of the variable "note" first

Choose an instrument

Add a "forever" loop around these two blocks

Drag the "note" variable from the "Data" section of the blocks palette

### △ Rising scale

This script makes a series of notes that play when the green flag is clicked. The pitch of each note gets higher one step at a time, and each note plays for half a beat.

## EXPERT TIPS

### Tempo

The speed of music is called its tempo. The tempo decides how long a beat is within a piece of music. There are three blocks for managing the tempo.

```
set tempo to 60 bpm
```

The tempo is measured in beats per minute, or "bpm."

```
change tempo by 60
```

Increase the tempo to make your music faster, or use a negative number to make it slower.

```
 tempo
```

Checking this box makes the sprite's tempo show on the stage.

## PROJECT 2

# Roll the dice

Simple programs can be both useful and fun. This program creates a dice that can be rolled. Play it to see who can get the highest number, or use it instead of a real dice when you play a board game.

## How to create a rolling dice

The dice in this program uses six costumes. Each costume shows a face of the dice with a different number on it—from one to six.

### SEE ALSO

◀ 40–41 Costumes

◀ 46–47 Simple loops

◀ 50–51 Variables

◀ 52–53 Math



- 1** Select the paintbrush button under the stage to draw a new sprite.



Draws a new sprite

- 2** Click the rectangle button on the left of the painting area. To make your dice colorful, select a solid color from the palette (see box below). Then in the painting area hold down the “shift” key, press the left mouse button, and then drag the mouse-pointer to make a square in the middle.



The rectangle button makes a square when the “shift” key is pressed

### EXPERT TIPS

## Changing colors

Under the painting area are the color controls. Click the solid rectangle to draw a block of solid color. Click the empty rectangle to draw an outline of a square or rectangle. Use the slider to change the thickness of the square’s lines. To choose a color, simply click it.

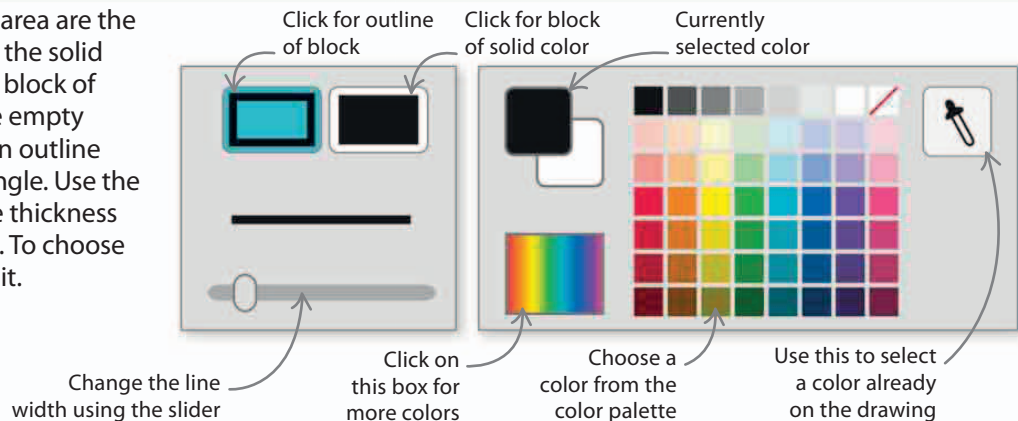

**3** Right-click on your costume to the left of the painting area, and choose “duplicate”. Repeat this step until you have six costumes.

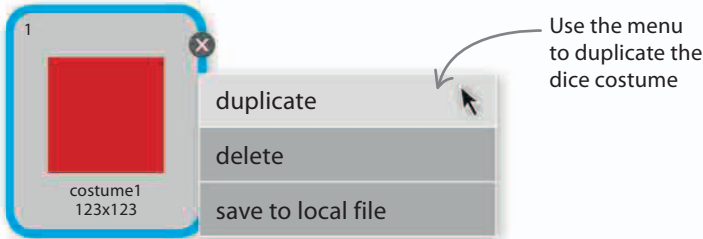

**4** Select a costume. Click the circle button on the painting area and choose a solid white color from the palette. Add spots to each of the six costumes until you have made all six sides of a dice.

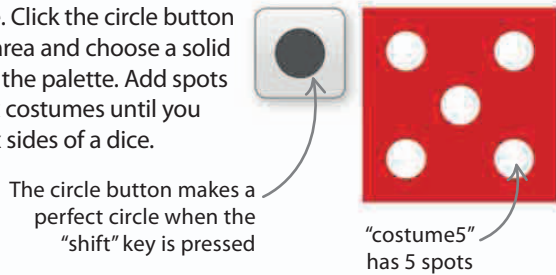

**5** Add the script below to the dice sprite. Press the spacebar to roll the dice. Try it a few times to check that you can see all of the costumes.

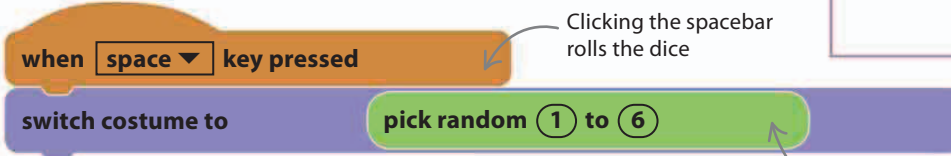

**6** Sometimes you’ll roll the same number twice, and it looks like the program isn’t working because the image doesn’t change. This script makes the dice change costumes five times before it stops. Each time you press the spacebar, it looks like it’s rolling.

This block selects a random costume

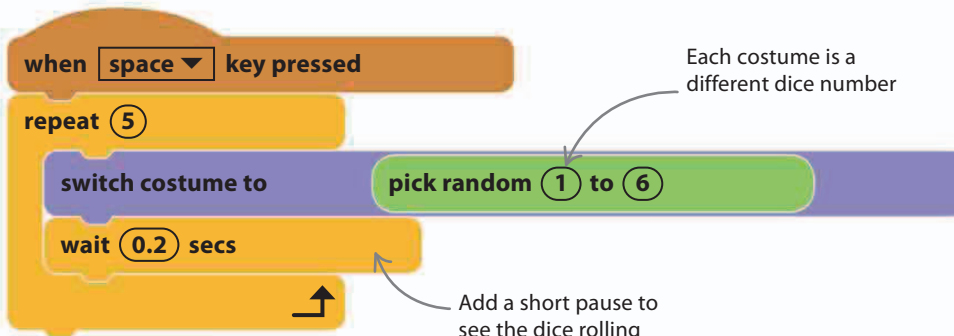

**EXPERT TIPS**

**Rotation tool**

To make the dice appear to roll when the script is run, you can rotate each costume to a different angle. Click on the “Convert to vector” button in the bottom right-hand corner. When you click back on to the painting area, a rotation tool will appear.

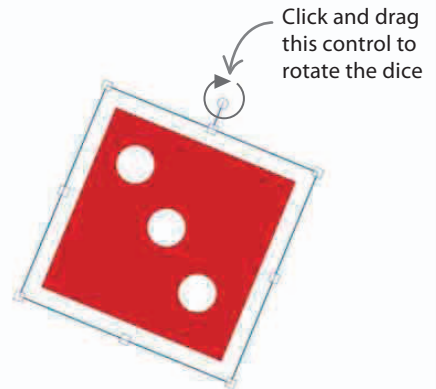

Don't forget to save your work

# True or false?

Computers decide what to do by asking questions and determining whether the answers are true or false. Questions that only have two possible answers are called “Boolean expressions”.

## SEE ALSO

Decisions and **64–65** >  
branches

Making **118–119** >  
decisions

## Comparing numbers

You can compare numbers using the “=” block from the “Operators” section of the blocks palette.

The numbers are equal, so “true” appears in the speech bubble

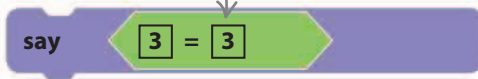

### △ True answer

Using an “=” block inside a speech block will make “true” or “false” appear in a sprite’s speech bubble.

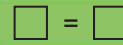

### ◁ The “=” block

This block will give one of two answers: “true” if the two numbers in the boxes are equal, and “false” if they aren’t.

These numbers are not equal, so “false” appears in the speech bubble

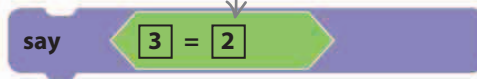

### △ False answer

If the numbers in the block are different, the sprite’s speech bubble will contain the word “false”.

## Comparing variables

You can use variables inside comparison blocks. It’s not worth comparing fixed numbers because the result will always be the same, whereas the value of variables can change.



### △ Create a variable

Click the “Data” button in the blocks palette and create a new variable called “age”. Set its value to 10 (click on the block to make sure the value has changed). Drag the “age” variable into the comparison blocks.

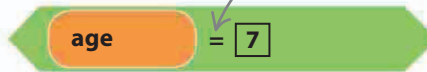

This sign means “equals”, so the block is asking if “age” is equal to 7. The answer here is “false”, because “age” is 10

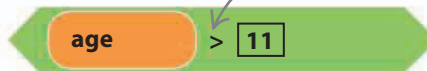

This sign means “more than”, so the block is asking if “age” is greater than 11. The answer is “false”, because 10 is not bigger than 11



This sign means “less than”, so the block is asking if “age” is less than 18. The answer will be “true”, as 10 is smaller than 18

### △ Comparing numbers

Find the green comparison blocks in the “Operators” menu. As well as checking whether two numbers are equal, you can check whether one is greater or less than another.



## EXPERT TIPS

## Comparing words

The “=” block is not just used for numbers; it can also be used to check whether two strings are the same. It ignores capital letters when comparing strings.

set **name** to **Lizzie**

△ **Create a variable**

To experiment with comparing strings, create a new variable called “name” and set its value to “Lizzie”.

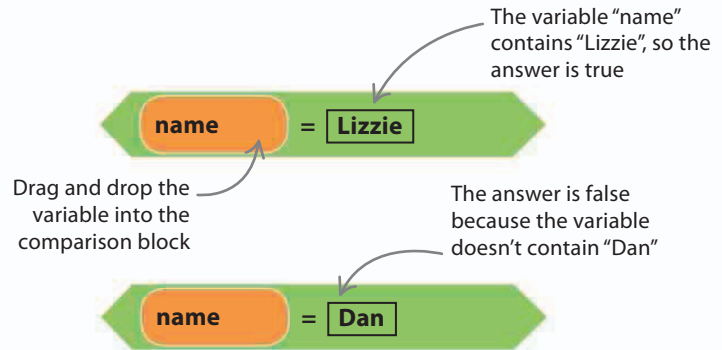

## Not!

The “not” block can simplify things by reversing the answer of a Boolean expression. For example, it’s easier to check if someone’s age is not 10 than to check every other possible age.



◁ **The “not” block**

The “not” block changes the answer around, from true to false and from false to true.

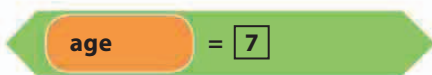

△ **Without the “not” block**

Here, 10 isn’t equal to 7, so the answer is false.

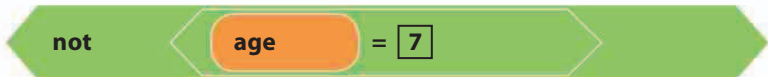

△ **With the “not” block**

Adding the “not” block to the same question changes the answer. Because 7 does not equal 10, the answer is now true.

## Combining questions

To ask more complicated questions, you can combine comparison blocks and ask more than one question at the same time.

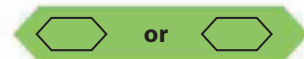

△ **Comparison blocks**

The “or” and “and” blocks are used to combine Boolean expressions in different ways.



Here, the answer is true when either the left or the right side is true

The answer here is only true when both the left and right sides are true



◁ **In practice**

The top block checks whether someone is younger than 18 or older than 65. The bottom block checks if they are aged 11, 12, 13, or 14.

# Decisions and branches

Tests of whether something is true or false can be used to tell the computer what to do next. It will perform a different action depending on whether the answer is true or false.

## Making decisions

The “if” blocks use Boolean expressions to decide what to do next. To use them, put other blocks inside their “jaws”. The blocks inside the “if” blocks will only run if the answer to the Boolean expression is true.

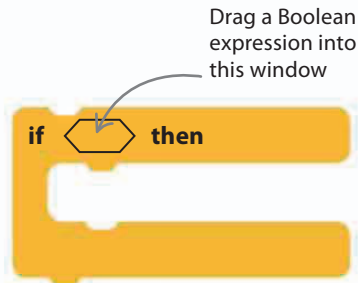

### △ “if-then” block

If a Boolean expression is true, the blocks between the “if-then” block’s jaws will run.

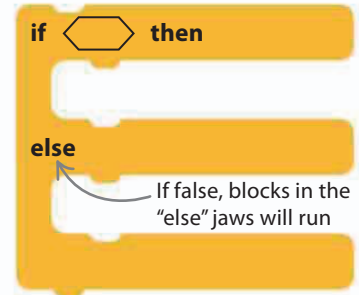

### △ “if-then-else” block

If the Boolean expression is true, the first set of blocks runs. If not, the second set runs.

### SEE ALSO

◀ 62–63 True or false?

Sensing and 66–67 > detecting

## Using the “if-then” block

The “if-then” block lets you choose whether or not to run part of a script depending on the answer to a Boolean expression. Attach this script to the cat sprite to try it out.

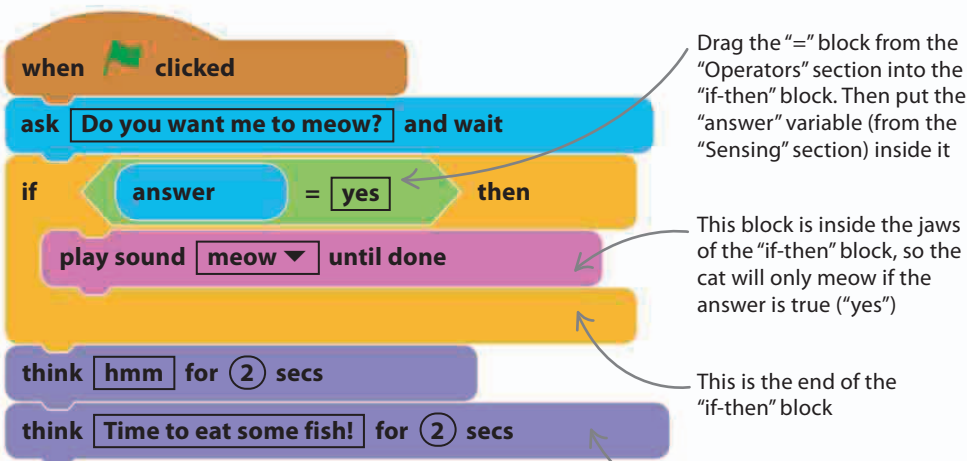

### △ Meowing cat

This program checks the Boolean expression and will only run the part between the “if-then” block’s jaws if it is true. This means that the cat only meows when you tell it to.

### Is answer yes?

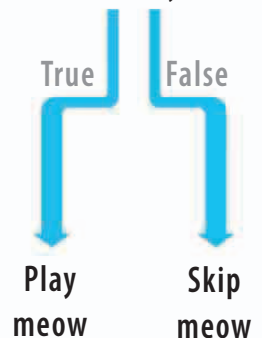

### △ How it works

The program checks whether the Boolean expression is true. If it is, it runs the blocks inside the “if-then” block’s jaws.

## Branching instructions

Often you want a program to do one thing if a condition is true, and something else if it is not. The “if-then-else” block gives a program two possible routes, called “branches”. Only one branch will run, depending on the answer to the Boolean expression.

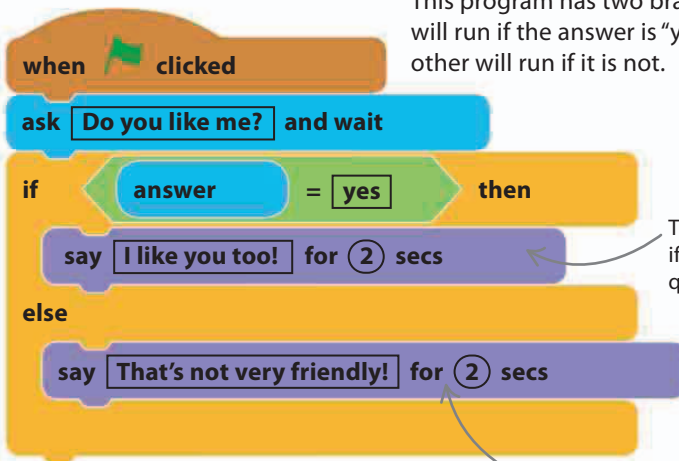

### ▽ Branching program

This program has two branches: one will run if the answer is “yes”, and the other will run if it is not.

This branch will run if the answer to the question is “yes”

This branch will run if the answer to the question is anything except “yes”

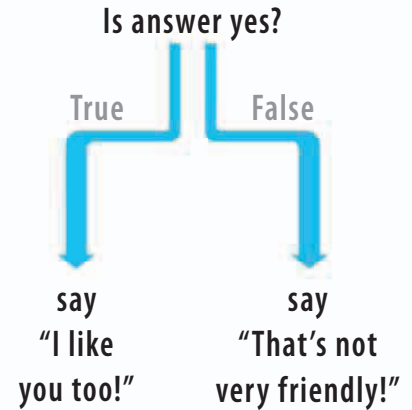

### △ How it works

The program checks whether you typed in “yes”. If so, it shows the first message. If not, it shows the second.

## ■ EXPERT TIPS

### Boolean shapes

The Boolean expression blocks in Scratch have pointed ends. You can put them into some nonpointed shaped holes too.

#### mouse down?

#### △ “Sensing” blocks

These blocks can test whether a sprite is touching another sprite, or whether a button is pressed.

#### repeat until

#### △ “Control” blocks

Several “Control” blocks have Boolean-shaped holes in them for Boolean expressions.

### ▷ Branches

Like the branches of a tree, branches of a program split and go in different directions.

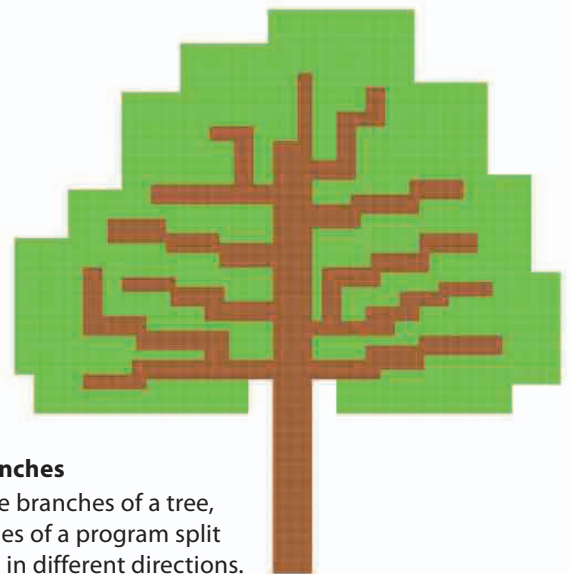

# Sensing and detecting

The “Sensing” blocks enable a script to see what is happening on your computer. They can detect keyboard controls, and let sprites react when they touch each other.

## Keyboard controls

Using “Sensing” blocks with “if-then” blocks allows you to move a sprite around the screen using the keyboard. The “key pressed?” block has a menu of most of the keys on the keyboard, so a sprite can be programmed to react to any key. You can also link actions to the click of a mouse button.

The script starts with a **when green flag clicked** block, followed by a **forever** loop. Inside the loop, there are four **if-then** blocks:

- if key up arrow pressed? then** **change y by 10**
- if key down arrow pressed? then** **change y by -10**
- if key left arrow pressed? then** **change x by -10**
- if key right arrow pressed? then** **change x by 10**

Arrows point from the text descriptions to the corresponding blocks in the script.

Putting everything inside a “forever” block means the script repeatedly checks for key presses

The script checks to see if the up arrow is pressed. If it is, the sprite moves upwards on the screen

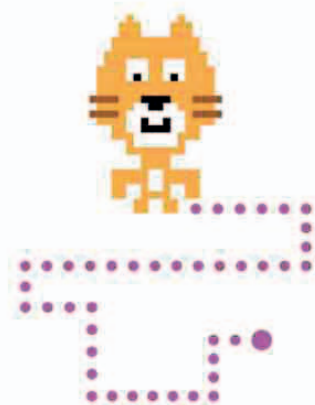

### △ Controlling sprites

Keyboard controls give you precise control over your sprites, which is especially useful in games.

### ◀ Movement script

This script lets you move sprites up, down, left, or right using the arrow keys on the keyboard.

### SEE ALSO

◀ 40–41 Costumes

◀ 56–57 Coordinates

This block checks if a key is being pressed. You can choose which key to check for

key **space** ▼ pressed?

This block checks if the mouse button is being pressed

mouse down?

### △ “Sensing” blocks

Adding these blocks into an “if-then” block allows the program to detect if a mouse button or key is being pressed.

## Sprite collisions

It can be useful to know when one sprite touches another—in games, for example. Use “Sensing” blocks to make things happen when sprites touch each other, or when a sprite crosses an area that is a certain color.

Use this block to identify when a sprite touches another sprite

touching **frog** ?

This block senses when a sprite touches an area of a particular color

touching color **■** ?

## Using “Sensing” blocks

Use the “Sensing” blocks to turn your controllable cat into a game. Start by adding the movement script created on the opposite page to the cat sprite, then add the “room1” backdrop and the elephant sprite. Using the “Sounds” tab, add the “trumpet2” sound effect to the elephant, then build it the script below.

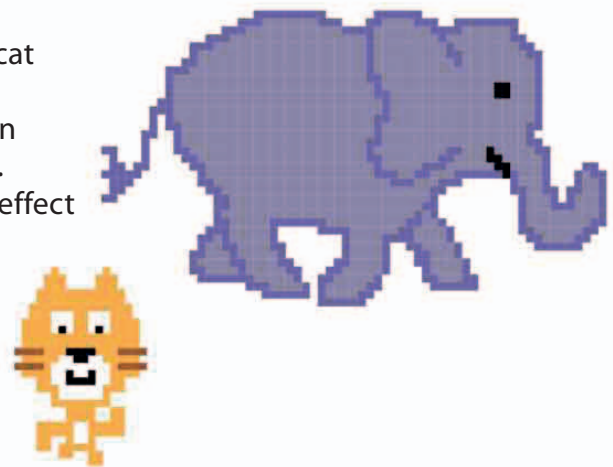

### ▽ Find the elephant

This script uses “Sensing” blocks to control the relationship between the cat and the elephant. As the cat gets nearer, the elephant grows. When the cat touches it, the elephant switches costume, makes a sound, and hides somewhere else.

when **clicked**

**forever**

set size to **200** - **distance to Sprite1** %

if **touching Sprite1 ?** then

switch costume to **elephant-b**

play sound **trumpet2** until done

switch costume to **elephant-a**

go to x: **pick random -240 to 240** y: **pick random -180 to 180**

The “forever” loop keeps sensing and adjusting the elephant’s size and position

This checks how far the cat is from the elephant

The farther away the cat is, the smaller the elephant will be

If the sprites touch, the blocks inside the “if-then” block run

This block selects a random place for the elephant to hide

# Complex loops

Simple loops are used to repeat parts of a program forever, or a certain number of times. Other, cleverer loops can be used to write programs that decide exactly when to repeat instructions.

## Looping until something happens

Add the “Dog1” sprite to a project, and then give the below script to the cat sprite. When you run the script, the “repeat until” block makes sure the cat keeps moving until it touches the dog. It will then stop and say “Ouch!”

This block stops the cat from standing on its head

Select “Dog1” from the drop-down menu

These instructions keep on repeating until the cat touches the dog

This will only happen when the cat touches the dog

### △ Testing the program

Move the dog out of the cat’s way and run the program. Then drag and drop the dog into the cat’s path to see what happens.

### SEE ALSO

◀ 46–47 Simple loops

◀ 62–63 True or false?



### △ “Repeat until” block

The blocks inside the “repeat until” block keep repeating until the condition is true (the cat touches the dog).



## Stop!

Another useful “Control” block is the “stop all” block, which can stop scripts from running. It’s useful if you want to stop sprites from moving at the end of a game.

This stops all scripts in a program

This stops only the script this block is in

This stops the sprite’s other scripts, but continues to run the script this block is in

◀ **Stopping scripts**  
Use the drop-down menu to choose which scripts to stop.

## Waiting

It's easier to play a game or see what's going on in a program if you can make a script pause for a moment. Different blocks can make a script wait a number of seconds or until something is true.

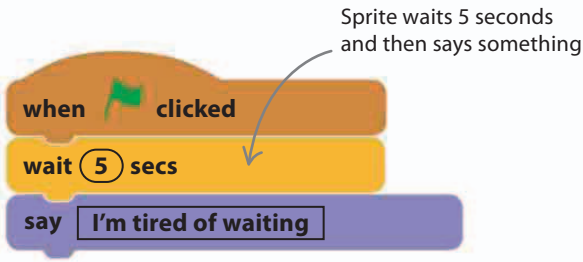

### △ "wait secs" block

With the "wait secs" block you can enter the number of seconds you want a sprite to wait.



### ◁ Waiting blocks

The "wait secs" block waits a set amount of time. The "wait until" block responds to what's happening in the program.

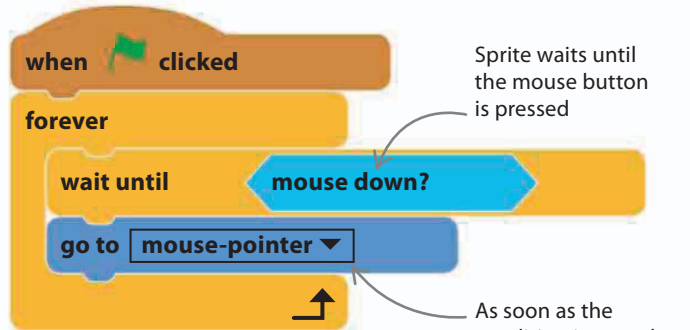

### △ "wait until" block

This block waits until the Boolean expression in it is true.

## Magnetic mouse

Different loops can be used together to make programs. This program starts once the mouse button is pressed. The sprite follows the mouse-pointer until the mouse button is released. It then jumps up and down five times. The whole thing then repeats itself because it's all inside a "forever" loop.

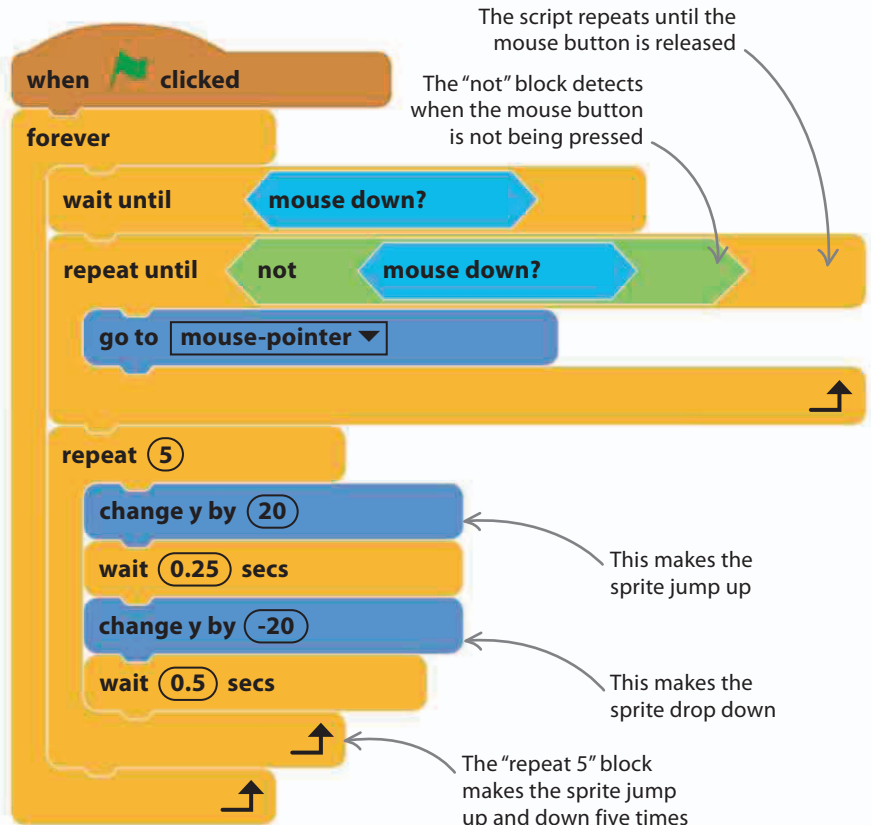

### ▷ Nested loops

Pay careful attention to how the loops are nested inside the "forever" block.

# Sending messages

Sometimes it's useful for sprites to communicate with each other. Sprites can use messages to tell other sprites what to do. Scratch also lets you create conversations between sprites.

## Broadcasting

The broadcast blocks in the “Events” menu enable sprites to send and receive messages. Messages don't contain any information other than a name, but can be used to fine-tune a sprite's actions. Sprites only react to messages that they are programmed to respond to—they ignore any other messages.

### SEE ALSO

◀ **38–39** Making things move

◀ **40–41** Costumes

◀ **44–45** Events

This “Events” block lets a sprite send a message to all the other sprites

**broadcast** message1 ▾

This block starts a script when a sprite receives a message

**when I receive** message1 ▾

### △ Broadcast blocks

One type of broadcast block lets a sprite send a message. The other tells the sprite to receive a message. Choose an existing message or create a new one.

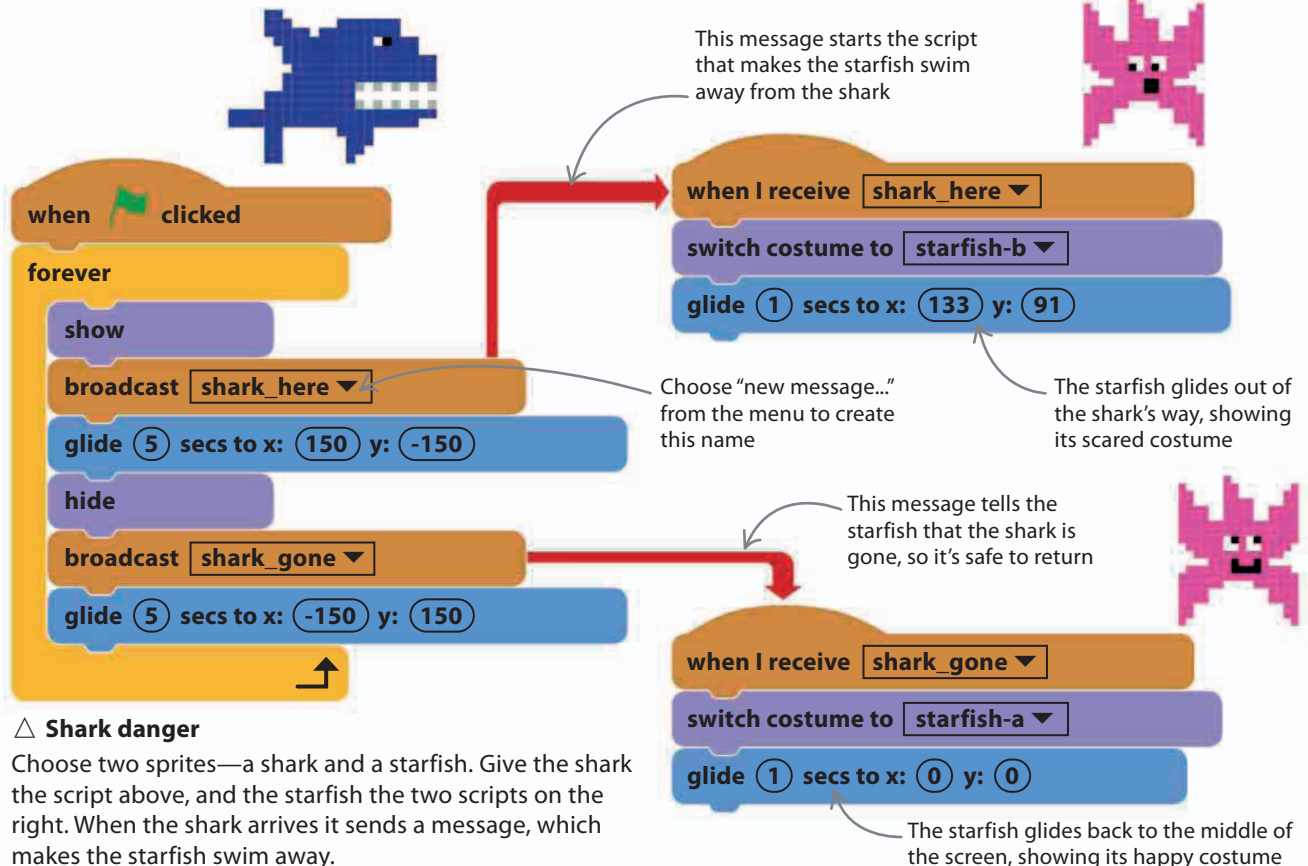

### △ Shark danger

Choose two sprites—a shark and a starfish. Give the shark the script above, and the starfish the two scripts on the right. When the shark arrives it sends a message, which makes the starfish swim away.



## Conversations

To create a conversation between sprites use “broadcast message and wait” blocks with “say” blocks, which make your sprites talk using speech bubbles. Start a new project and add two monkey sprites to it. Give the script on the left to one monkey, and the two scripts on the right to the other.

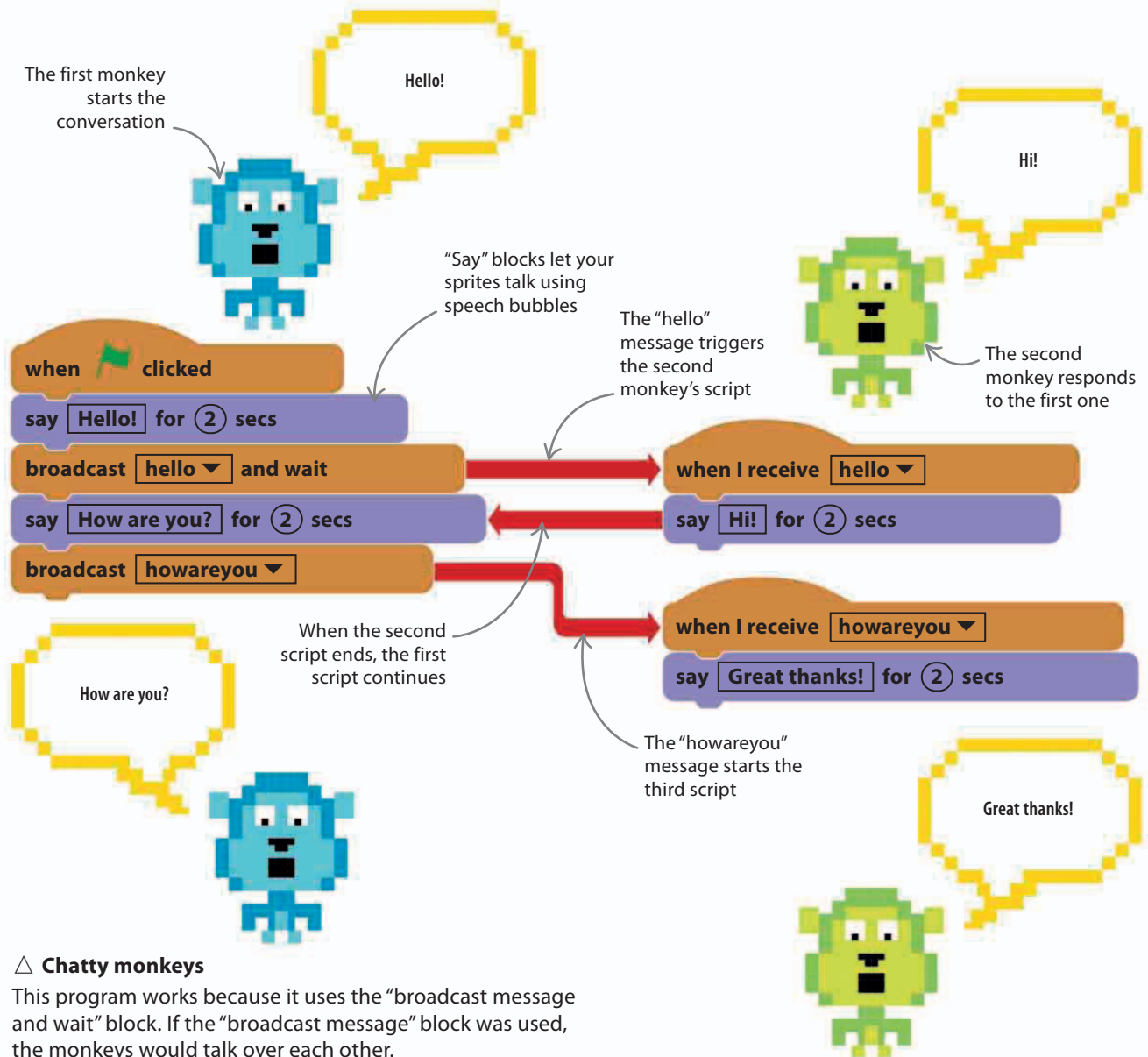

**broadcast** **message1** and wait

### △ Waiting blocks

This block sends a message, then waits for all the scripts that react to the message to finish before the program continues.

### △ Chatty monkeys

This program works because it uses the “broadcast message and wait” block. If the “broadcast message” block was used, the monkeys would talk over each other.

# Creating blocks

To avoid repeating the same set of blocks over and over again, it's possible to take a shortcut by creating new blocks. Each new block can contain several different instructions.

## Making your own block

You can make your own blocks in Scratch that run a script when they're used. Try this example to see how they work. Programmers call these reusable pieces of code "subprograms" or "functions".

### SEE ALSO

< 50-51 Variables

Time to 82-83 >  
experiment



- 1 Create a new block**  
Click on the "More Blocks" button, and then select "Make a Block". Type the word "jump" and click "OK".

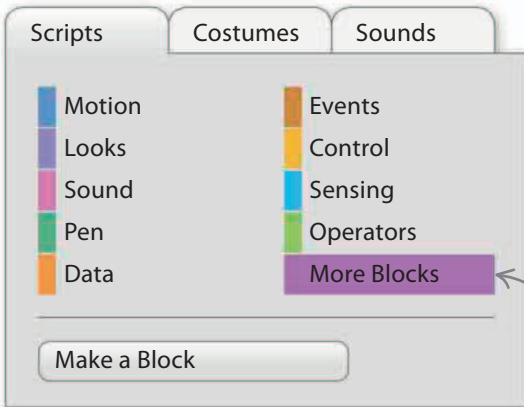

- 2 New block appears**  
Your new block "jump" appears in the blocks palette, and a "define" block appears in the scripts area.



Click here to make a new block

The new block

Define the "jump" block in the scripts area

- 3 Define the block**  
The "define" block tells Scratch which blocks to run when using the new block. Add this script to define the block.

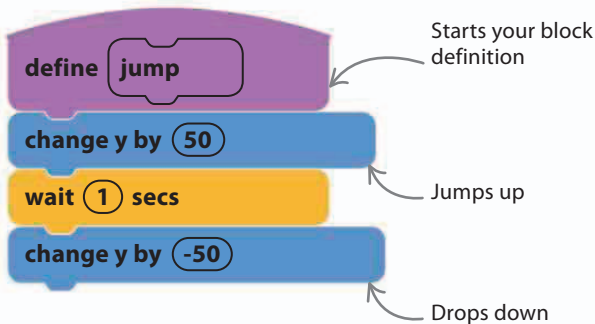

- 4 Use the block in a script**  
The new block can now be used in any script. It's as if those jumping blocks were in the script individually.

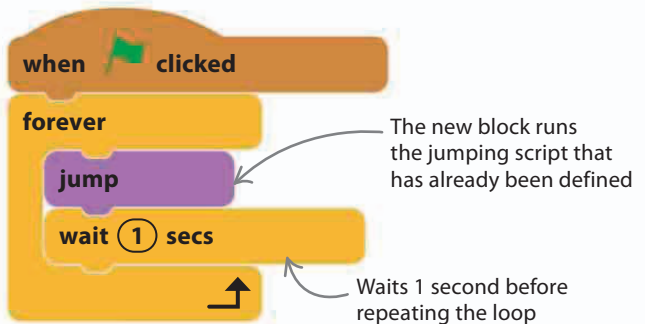

## Blocks with inputs

Windows in a new block can be used to give it numbers and words to work with. These holes can be used to change how far the block moves a sprite.

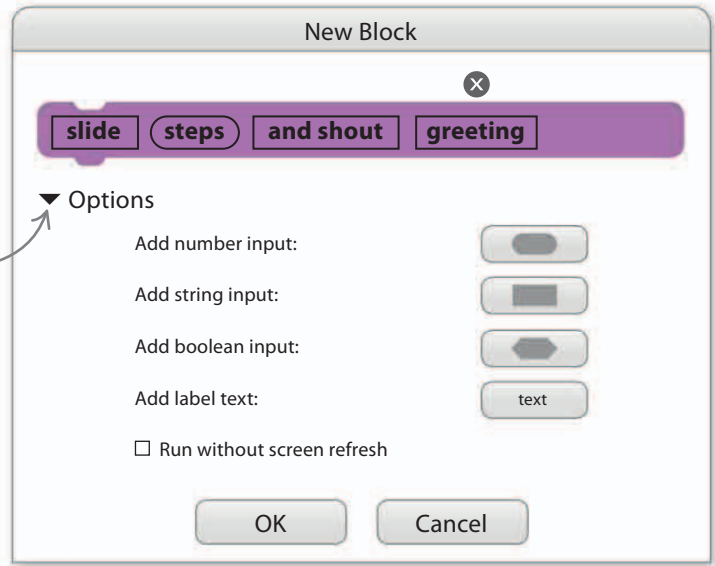

Click here to see all of the options

**1 Make a new block**  
Make a new block called "slide" and then click on "Options". Now select "Add number input" and type "steps". Select "Add label text" and change it to "and shout". Click "Add string input" and call it "greeting". Then click "OK".

**2 Define the block**  
In the "define" block, the holes are replaced with variables called "steps" and "greeting". Drag these variables from the "define" block into the script wherever you need them. Add this script to your sprite.

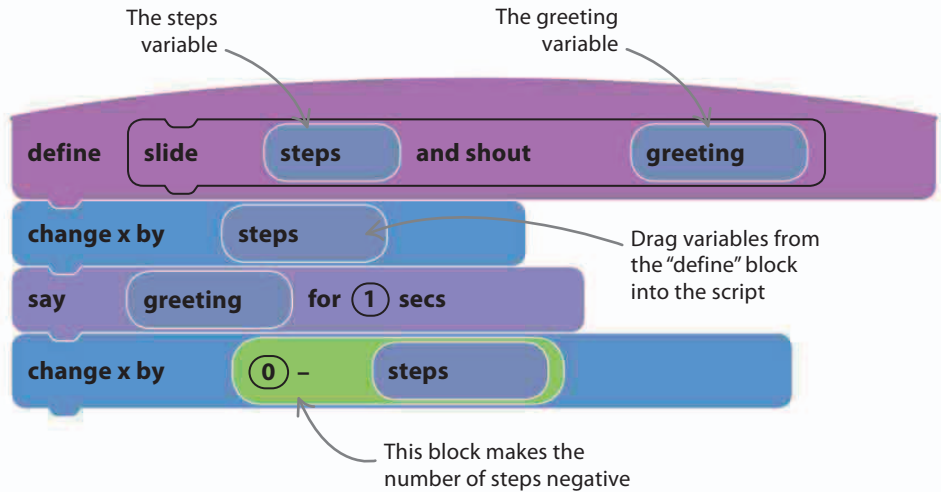

**3 Use the block in a script**  
Now add the below script to a sprite. By putting different numbers of steps and greetings into the block, you can make your sprite behave differently.

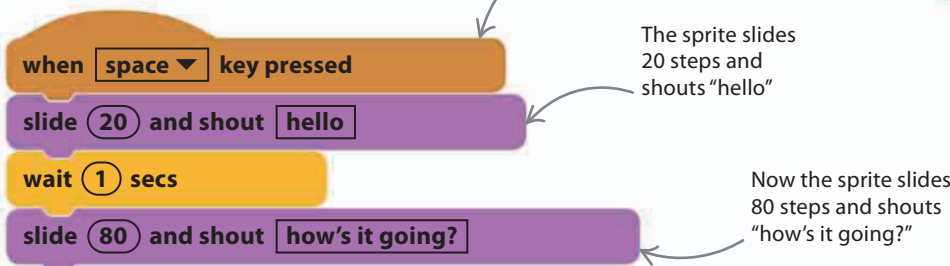

Use a sensible name for a new block so the program will be easier to read and change.



## PROJECT 3

# Monkey mayhem

This exciting, fast-paced game brings together all of the Scratch skills you've learned so far. Follow these steps to create your very own "Monkey mayhem" and see if you can hit the bat with the bananas!

### SEE ALSO

◀ 40–41 Costumes

◀ 38–39 Making things move

◀ 66–67 Sensing and detecting

## Getting started

Start a new Scratch project. The cat sprite isn't needed for this project. To remove it, right-click on it in the sprite list and then click "delete" in the menu. This will leave you a blank project to work on.

**1** Add a new backdrop from the backdrop library. This button is found to the left of the sprite list.

Click here to add a new backdrop from the backdrop library

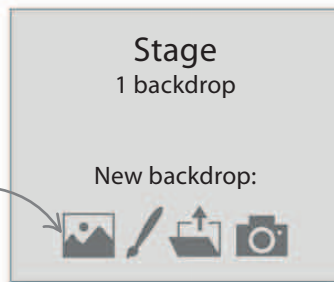

**2** Double-click to select the "brick wall1" backdrop. The brick wall works well for this game, but if you prefer, you could use a different backdrop instead.

Double-click on a backdrop in the backdrop library to make it appear on the stage

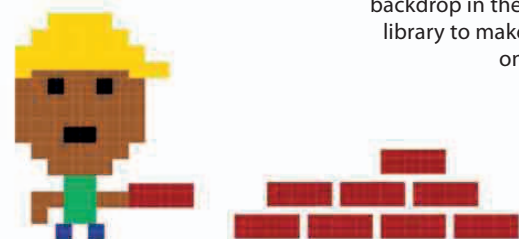

### EXPERT TIPS

## Avoiding errors

This is the biggest Scratch program you've tried so far, so you might find that the game doesn't always work as you expect it to. Here are some tips to help things run smoothly:

**Make sure you add scripts** to the correct sprite.

**Follow the instructions** carefully. Remember to make a variable before using it.

**Check that all the numbers** in the blocks are correct.

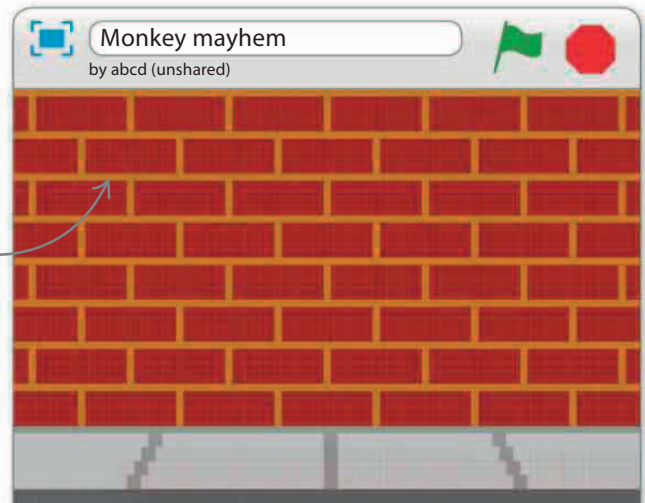

**3** Go to the sprite library to add a new sprite to the game. Select "Monkey1" from the "Animals" section. The user will control this sprite in the game.



Click here to choose a new sprite from the library

**4** Give the monkey the script below. Remember—all of the different blocks can be found in the blocks palette, organized by color. In this script, "Sensing" blocks are used to move the monkey around the stage using the keyboard arrow keys. Run the script when you've finished to check it works.

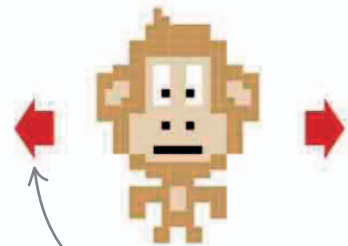

The arrow keys on the keyboard will make the monkey run left and right

```

when clicked
  set rotation style left-right
  go to x: 0 y: -90
  forever
    if key left arrow pressed? then
      point in direction -90
      move 10 steps
      next costume
    if key right arrow pressed? then
      point in direction 90
      move 10 steps
      next costume
  
```

This "Motion" block keeps the monkey upright

Moves the monkey to his start position at the bottom of the stage

This "Sensing" block detects when the left arrow key is pressed

-90 makes the monkey point to the left

This block makes the monkey look like it is walking by switching between its costumes

90 makes the monkey point to the right

Moves the monkey 10 steps



Don't forget to save your work



## MONKEY MAYHEM

### Adding more sprites

The monkey can now be moved across the stage using the left and right arrow keys. To make the game more interesting, add some more sprites. Give the monkey some bananas to throw, and a bat to throw them at!

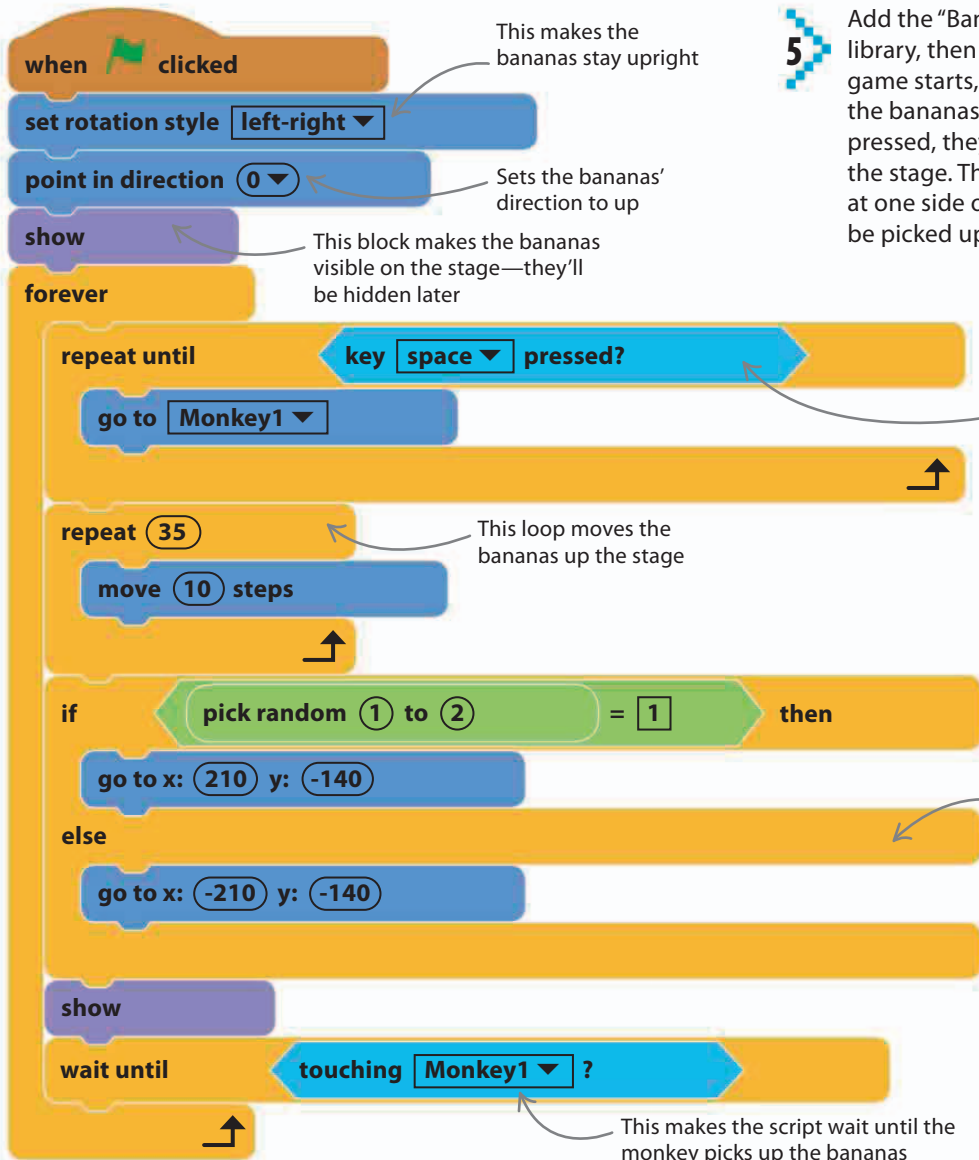

**5** Add the "Bananas" sprite from the sprite library, then give it this script. When the game starts, the monkey will be holding the bananas. When the spacebar is pressed, they will shoot vertically up the stage. The bananas then reappear at one side of the stage, where they can be picked up again.

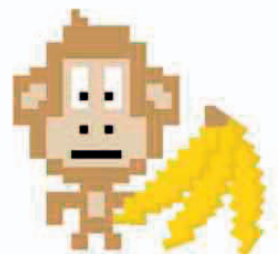

**6** The next step is to add a flying bat and make it drop to the ground if it's hit by the bananas. Add "Bat2" from the sprite library, then create a new variable called "Speed" (for the bat sprite only). To create a new variable, first click the "Data" button in the blocks palette, and then select the "Make a Variable" button. Untick the box by the "Speed" variable in the "Data" section so it doesn't appear on the screen.

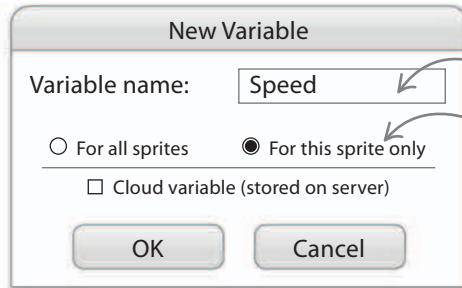

Name the new variable "Speed"  
This variable will only be used with the bat sprite

**7** Add the below script to the bat. In the main "forever" loop, the bat moves to a random position on the left of the stage, chooses a random speed, then moves backward and forward across the stage until the bananas hit it. When the bat is hit, it drops to the ground.



```

when clicked
  set rotation style left-right
  forever
    go to x: -300 y: pick random 1 to 100
    point in direction 90
    set Speed to pick random 1 to 20
    repeat until touching Bananas ?
      move Speed steps
      if on edge, bounce
    broadcast hitbybananas
    point in direction 180
    repeat 40
      move 10 steps
  
```

This keeps the bat sprite upright

The bat starts off on the left of the stage, at a random height

Sets the bat's direction to right

Picks a random speed

This makes the bat keep moving until it's hit

Drag the "Speed" variable from the "Data" section into this block

Create this "broadcast" block to tell other sprites that the bat has been hit. This will be useful later in the project

Sets the direction of the bat to down

Makes the bat fall down and off the stage



Don't forget to save your work





## MONKEY MAYHEM

### The finishing touches

To make the game even more exciting, you can add a timer, use a variable to keep score of how many bats the player hits, and add a game over screen that appears once the player is out of time.

**8** Create a new variable called “Time”. Make sure it’s available for all sprites in the game by selecting the “For all sprites” option. Check that the box next to the variable in the blocks palette is ticked, so that players can see the time displayed on the stage.

Time

**9** Click on the small picture of the stage in the stage list, then select the “Backdrops” tab above the blocks palette. Right-click the existing backdrop and duplicate it. Add the words “GAME OVER” to the new backdrop.

Use the text tool to write on the duplicate backdrop

Your “game over” screen will look something like this



**10** Click the “Scripts” tab and add this script to the stage to set up the timer. When the timer begins, it starts a count-down loop. When the loop finishes, the “GAME OVER” screen is shown and the game ends.

```

when clicked
  switch backdrop to brick wall1
  set Time to 30
  repeat until Time = 0
    wait 1 secs
    change Time by -1
  switch backdrop to brick wall2
  stop all
  
```

This sets the time limit to 30 seconds

Counts down until the timer reaches zero

Switches to the “GAME OVER” backdrop

Ends the game



**11** Click the bananas sprite in the sprite list. Create a new variable called "Score" and make it available for all sprites. Move the score to the top right of the stage by dragging it.

Put a check in the box to show the score on the stage



**12** Add this short script to the bananas sprite. It sets the score to 0 at the beginning of the game.

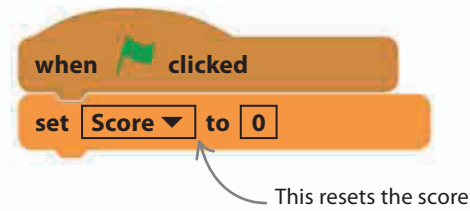

**13** Add this script to the bananas sprite too. When the bananas hit the bat, it plays a sound, increases the score by 10, and hides the bananas.

Makes the bananas disappear

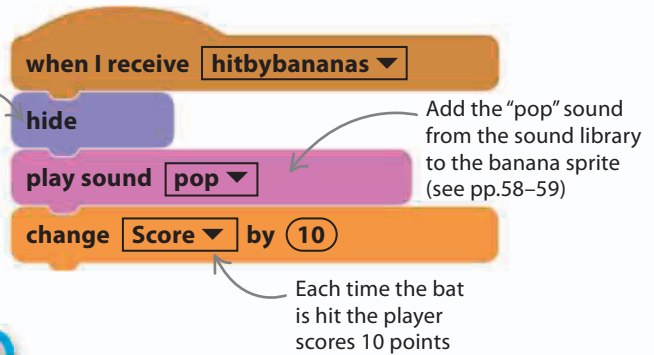

**14** Next add some music to the game. Click on the stage and select the "Sounds" tab above the blocks palette. Load the "eggs" music from the sound library.

Add the "eggs" music from the "Sounds" tab

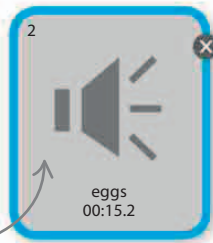

**15** Add the script below to the stage. It plays the "eggs" music on a loop, but will stop when the "stop all" block ends the game.

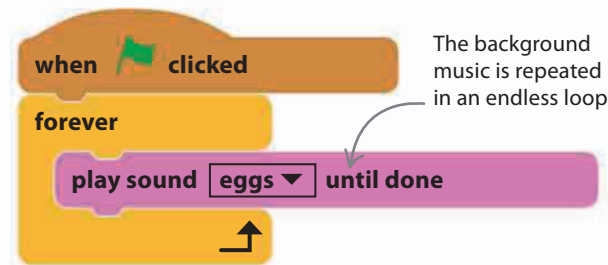

Don't forget to save your work

REMEMBER

Achievements

Congratulations—you've built a complete Scratch game. Here are some of the things you have achieved so far:

- Made a sprite throw objects** at another sprite.
- Made a sprite fall** off the stage once hit.
- Added a time limit** to your game.
- Added background music** that plays as long as the game continues.
- Added a game over screen** that appears at the end of the game.



## MONKEY MAYHEM

### Time to play

Now the game is ready to play. Click the green flag to start and see how many times you can hit the bat with the bananas before the time runs out.



#### △ Controls

Steer the monkey left and right with the keyboard cursor keys. Tap the spacebar to fire bananas at the bat.

To make the game harder, make the bat move faster

Make up a new title for the game and type it in

To make the game last longer, try increasing the time limit

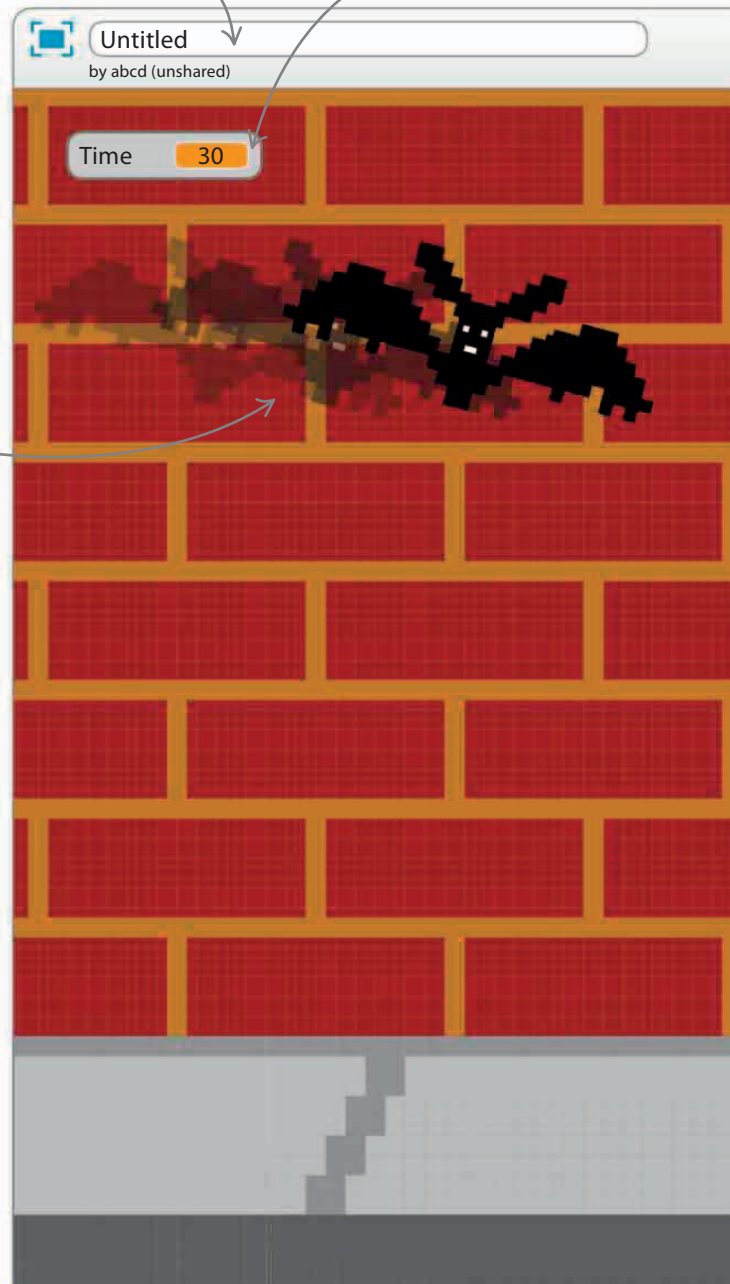

### EXPERT TIPS

#### Adding more sprites

To add more bats to aim at, right-click the bat in the sprite list and select "duplicate". A new bat will appear with all the same scripts as the first one. Try adding some other flying sprites:

1. **Add a sprite** from the sprite library. The flying hippo ("Hippo1") is great for this game.
2. **Click on the bat** in the sprite list.
3. **Click the bat's script** and hold the mouse button down.
4. **Drag the bat's script** on to the new sprite in the sprite list.
5. **The script will copy across** to the new sprite.



Try out different backdrops and see how the game looks

Play the game three times and see how high you can score

Click the red stop button to end the game early

Score 0

You can edit the program to give the player more points for each successful hit

To make the game harder, try changing the code to make the bananas move more slowly

Try changing the monkey into a different sprite

### ◀ Going bananas

There are countless ways to change Monkey Mayhem. By adjusting the speeds, scores, sounds, and sprites, you can create your own unique version of the game.

# Time to experiment

Now you've learned the basics of Scratch, you can experiment with some of its more advanced features. The more you practice, the better your coding will become.

## SEE ALSO

What is **86-87** ›  
Python?

Simple **102-103** ›  
commands

## Things to try

Not sure what to do next with Scratch? Here are a few ideas. If you don't feel ready to write a whole program on your own yet, you can start with one that has already been written and change parts of it.

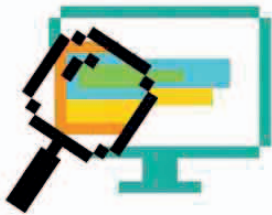

Scratch allows you to look at the coding of all projects on its website

### △ Look at code

Looking at other programs is a great way to learn. Go through projects shared on the Scratch website. What can you learn from them?

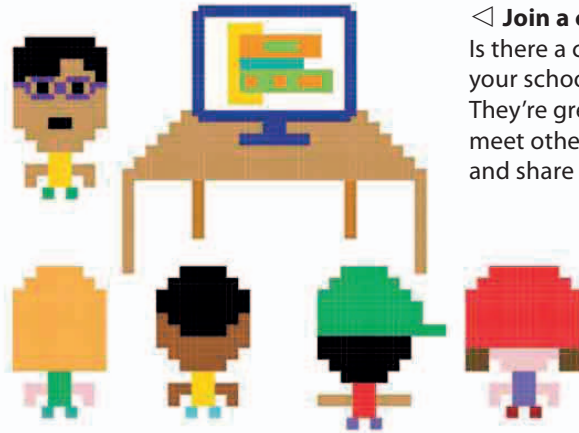

### ◁ Join a coding club

Is there a coding club in your school or local area? They're great places to meet other Scratch users and share ideas.

### ▷ Remix existing projects

Can you improve the projects on the Scratch website? Scratch lets you add new features and then share your version.

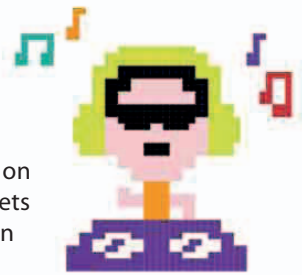

## Backpack

The backpack enables you to store useful scripts, sprites, sounds, and costumes and move them from project to project. It's found at the bottom of the Scratch screen.

### ▷ Drag and drop

You can drag sprites and scripts into your backpack, then add them to other projects.

Drag and drop to copy a script or sprite into the backpack

A sprite in the backpack

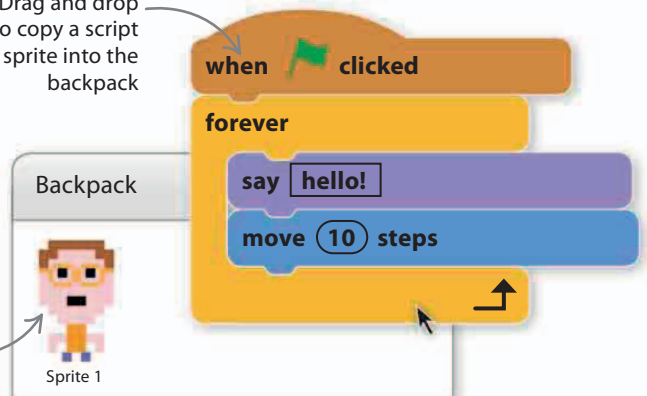

## Help!

It can be hard to write a program if you don't know about some of the blocks you could use. Scratch has a help menu to make sure you understand every block.

- 1 Block help**  
To find out more about a particular block, click the "block help" button on the cursor tools bar at the top of the screen.



- 2 Ask a question**  
The cursor will turn into a question mark. Use this to click on the block you want to know about.

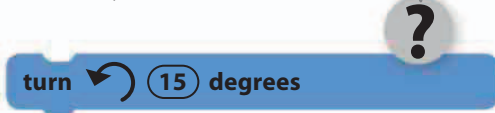

- 3 Help window**  
The help window opens to tell you how the block works, with tips on how it can be used.

🏠 Tips ✕

**turn**

Turn left

**when**  key pressed

**turn**  degrees

30°

Type in the number of degrees you want the sprite to rotate.

(If you type in a negative number, the sprite will go in the opposite direction.)

## Learn another language

You're now on your way to mastering your first programming language. Learning other languages will enable you to write different types of programs. Why not try Python next? What you've already learned about Scratch will help you pick up Python quickly.

- ▷ **Similar to Scratch**  
Python uses loops, variables, and branches too. Use your Scratch knowledge to start learning Python!

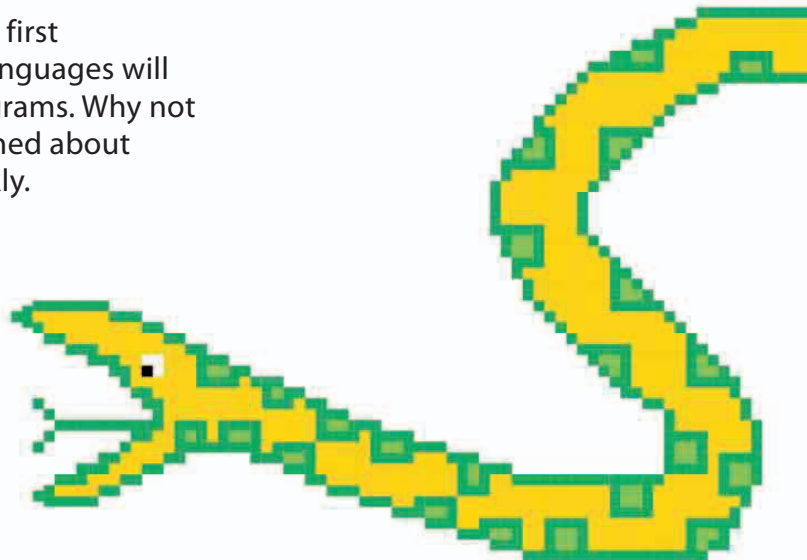



# Playing with Python



# What is Python?

Python is a text-based programming language. It takes a bit longer to learn than Scratch, but can be used to do much more.

## SEE ALSO

Installing **88–91** ›  
Python

Simple **102–103** ›  
commands

Harder **104–105** ›  
commands

## A useful language

Python is a versatile language that can be used to make many different types of programs, from word processing to web browsers. Here are a few great reasons to learn Python.

### 1 Easy to learn and use

Python programs are written in a simple language. The code is quite easy to read and write, compared to many other programming languages.

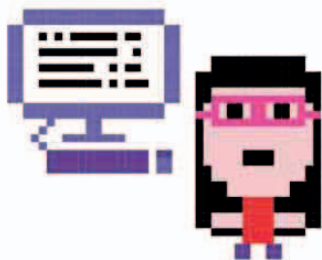

### 2 Contains ready-to-use code

Python contains libraries of preprogrammed code that you can use in your programs. It makes it easier to write complex programs quickly.

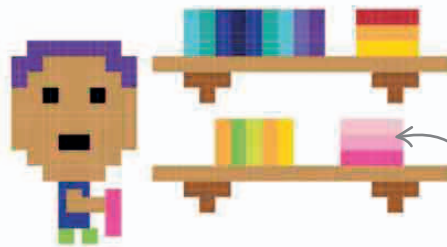

Python contains lots of programs you can use and build on

### 3 Useful for big organizations

Python is powerful. It can be used to write real-world programs. It is used by Google, NASA, and Pixar, among others.



## EXPERT TIPS

### Getting started

Before learning how to program in Python, it's useful to get familiar with how it works. The next few pages will teach you how to:

**Install Python:** Python is free, but you'll have to install it yourself (see pp.88–91).

**Use the interface:** Make a simple program and save it on the computer.

**Experiment:** Try some simple programs to see how they work.



## Scratch and Python

Lots of elements that are used in Scratch are also used in Python—they just look different. Here are a few similarities between the two languages.

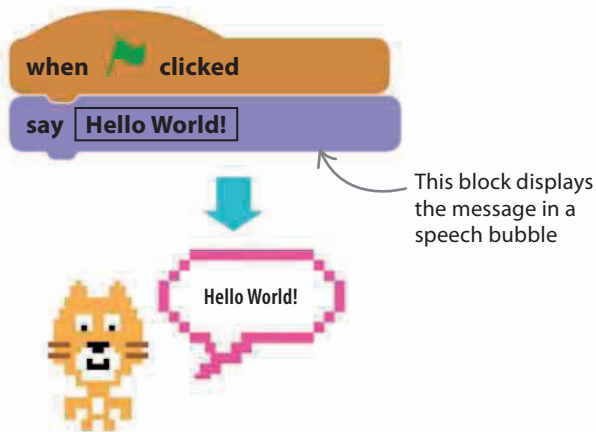

### △ Print in Scratch

In Scratch, the “say” block is used to show something on the screen.

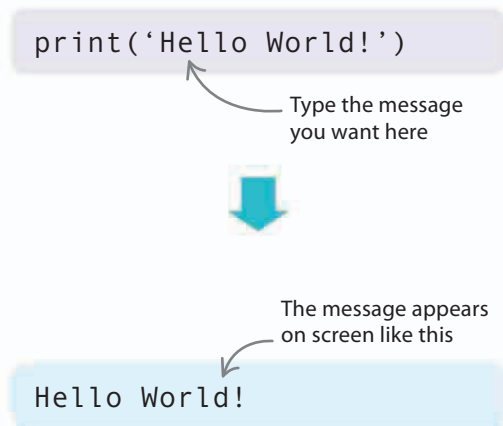

### △ Print in Python

In Python, a command called “print” displays text on the screen.

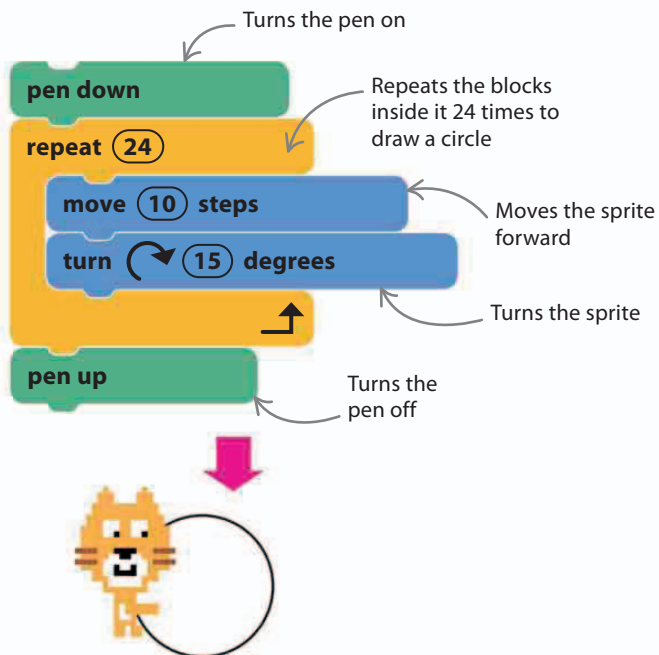

### △ Turtle graphics in Scratch

The script above uses the “pen down” block to move the cat sprite and draw a circle.

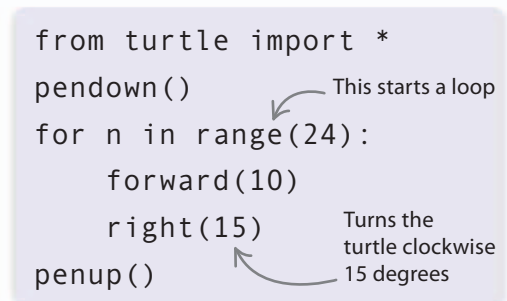

### △ Turtle graphics in Python

There's also a turtle in Python. The code above can be used to draw a circle.

# Installing Python

Before you can use the Python programming language, you need to download and install it on your computer. Python 3 is free, easy to install, and works on Windows PCs, Macs, and Linux operating systems such as Ubuntu.

## What is IDLE?

When you install Python 3, you'll also get a free program called IDLE (Integrated DeveLopment Environment). Designed for beginners, IDLE includes a basic text editor that allows you to write and edit Python code.

### WINDOWS

#### △ Windows

Before you download Python, check what kind of operating system your computer has. If you have Windows, find out whether it's the 32-bit or 64-bit version. Click the "Start" button, right-click "Computer", and left-click "Properties". Then choose "System" if the option appears.



### MAC

#### △ Mac

If you use an Apple Mac, find out which operating system it has before you install Python. Click the apple icon in the top left and choose "About This Mac".

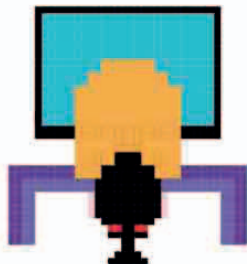

### UBUNTU

#### △ Ubuntu

Ubuntu is a free operating system that works just like Windows and Macs. To find out how to install Python on Ubuntu, turn to page 91.



### EXPERT TIPS

#### Saving code

When saving work in Python, you will need to use the "File > Save As..." menu command so you can name your files. First create a folder to keep all your files in. Give the folder a clear name, like "PythonCode", and agree with the person who owns the computer where to keep it.

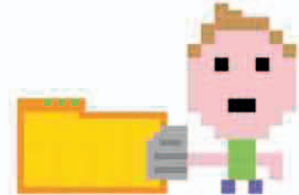

## Python 3 on Windows

Before you install Python 3 on a Windows PC, make sure you get permission from the computer's owner. You may also need to ask the owner to provide an admin password during installation.

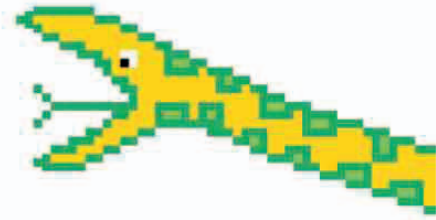

- 1 Go to the Python website**  
Type the address below into your Internet browser to open the Python website. Click on "Download" to open the download page.

Q <http://www.python.org>

This is the URL (web address) for Python

- 2 Download Python**  
Click on the latest version of Python for Windows, beginning with the number 3, which will be near the top of the list.

- Python 3.3.3 Windows x86 MSI Installer
- Python 3.3.3 Windows x86-64 MSI Installer

Choose this if you have a 32-bit version of Windows

Don't worry about the exact number, as long as it has a 3 at the front

Choose this if you have a 64-bit version of Windows

- 3 Install**  
The installer file will download automatically. When it finishes, double-click it to install Python. Choose "install for all users" and click "next" at each prompt, without changing the default settings.



The Windows installer icon appears while Python is installing

- 4 Run IDLE**  
Now check that the program installed correctly. Open the Windows "Start" menu, click on "All Programs", "Python", and then choose "IDLE".

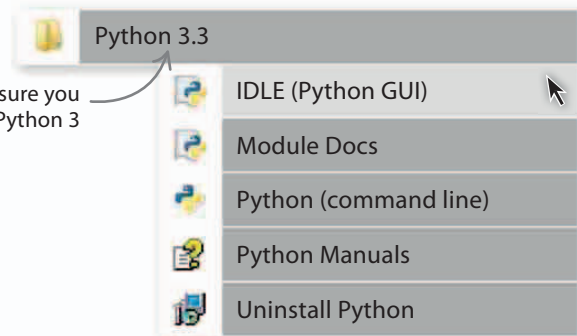

Make sure you select Python 3

- 5 A Python window opens**  
A window like the one below should open up. You can now start coding – just type into the window after the angle brackets (>>>).

```

IDLE  File  Edit  Shell  Debug  Window  Help
-----
Untitled

Python 3.3.3 (v3.3.3:c3896275c0f6, Nov 18 2013, 21:19:30) [MSC v.1600
64 bit (AMD64)] on win32
Type "copyright", "credits" or "license()" for more information.
>>>
  
```

Begin typing code here

## Python 3 on a Mac

Before you install Python 3 on a Mac, make sure you get permission from the computer's owner. You may also need to ask the owner to provide an admin password during installation.

### 1 Go to the Python link

Type the address below into your web browser to open the Python website. Click on "Download" in the navigation panel to go to the download page.

Don't worry about the exact number, as long as it has a 3 at the front

### 3 Install

Double-click the .dmg file. A window will open with several files in it, including the Python installer file "Python.mpkg". Double-click it to start the installation.

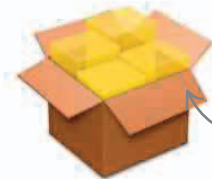

Python installer file

Python.mpkg

### 2 Download Python

Check which operating system your Mac has (see page 88) and click on the matching version of Python 3. You'll be prompted to save a .dmg file. Save it on your Mac desktop.

This version is for newer Macs

- Python 3.3.3 Mac OS X 64-bit... (for Mac OS X 10.6 and later)
- Python 3.3.3 Mac OS X 32-bit... (for Mac OS X 10.5 and later)

This version runs on most Macs

### 4 Run IDLE

During installation, click "next" at each prompt to accept the default settings. After installation ends, open the "Applications" folder on your Mac and open the "Python" folder (make sure you select Python 3, not Python 2). Double-click "IDLE" to check the installation worked.



IDLE icon

### 5 A Python window opens

A window like the one below should open. You can now start coding—just type into the window after the angle brackets.

```

IDLE  File  Edit  Shell  Debug  Window  Help
Untitled
Python 3.3.3 (v3.3.3:c3896275c0f6, Nov 16 2013, 23:39:35)
[GCC 4.2.1 (Apple Inc. build 5666) (dot 3)] on darwin
Type "copyright", "credits" or "license()" for more information.
>>>

```

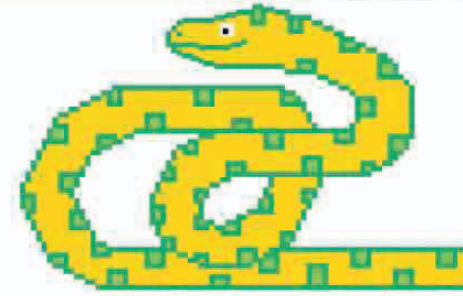

## Python 3 on Ubuntu

If you use the Linux operating system Ubuntu, you can download Python 3 without having to use a browser—just follow the steps below. If you have a different version of Linux, ask the computer’s owner to install Python 3 for you.

### 1 Go to Ubuntu Software Center

Find the Ubuntu Software Centre icon in the Dock or the Dash and double-click it.



### 2 Enter “Python” into the search bar

You will see a search box in the top right. Type “Python” in the box and press enter.



### 3 Select IDLE and click “Install”

Look for “IDLE (using Python)”. Highlight the version beginning with the number 3 and click “Install”.



### 4 Select Dash

After installation finishes, check the program works. First, select the Dash icon in the top right.



Dash icon

### 5 Run IDLE

Enter “IDLE” into the search bar and double-click on the blue-and-yellow “IDLE (using Python 3)” icon.



IDLE icon

### 6 A Python window opens

A window like the one below should open. You can now start coding—just type into the window after the angle brackets.

```

IDLE  File  Edit  Shell  Debug  Window  Help
Untitled
Python 3.2.3 (default, Sep 25 2013, 18:25:56)
[GCC 4.6.3] on linux2
Type "copyright", "credits" or "license()" for more information.
>>>
  
```

# Introducing IDLE

IDLE helps you write and run programs in Python. See how it works by creating this simple program that writes a message on the screen.

## SEE ALSO

◀ **88–91** Installing Python

Which **106–107** window?

## Working in IDLE

Follow these steps to make a Python program using IDLE. It will teach you how to enter, save, and run programs.

- 1 Start IDLE**  
Start up IDLE using the instructions for your computer's operating system (see pp.88–91). The shell window opens. This window shows the program output (any information the program produces) and any errors.

## EXPERT TIPS

### Different windows

Python uses two different windows—the “shell” window and the “code” window (see pages 106–107). We've given them different colors to tell them apart.

**Shell window**

**Code window**

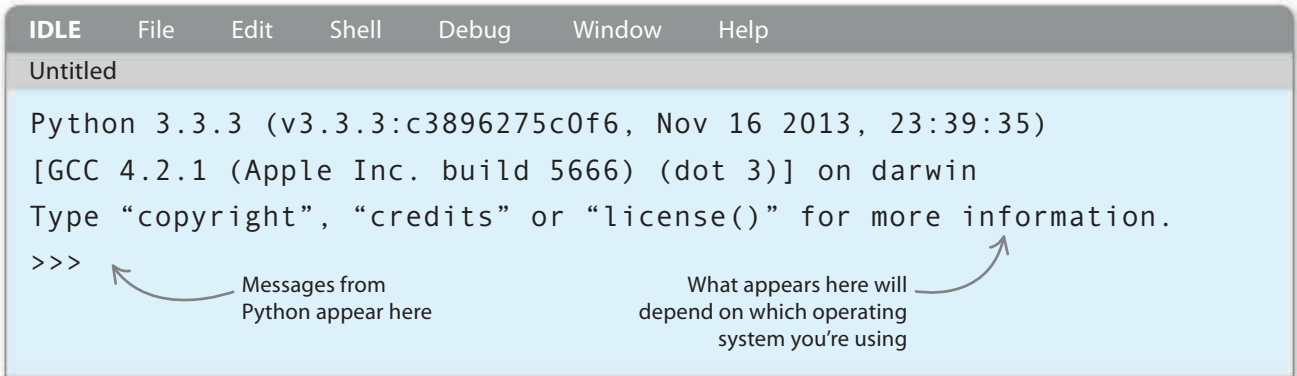

- 2 Open a new window**  
Click the “File” menu at the top of the shell window and select “New Window”. This opens the code window.

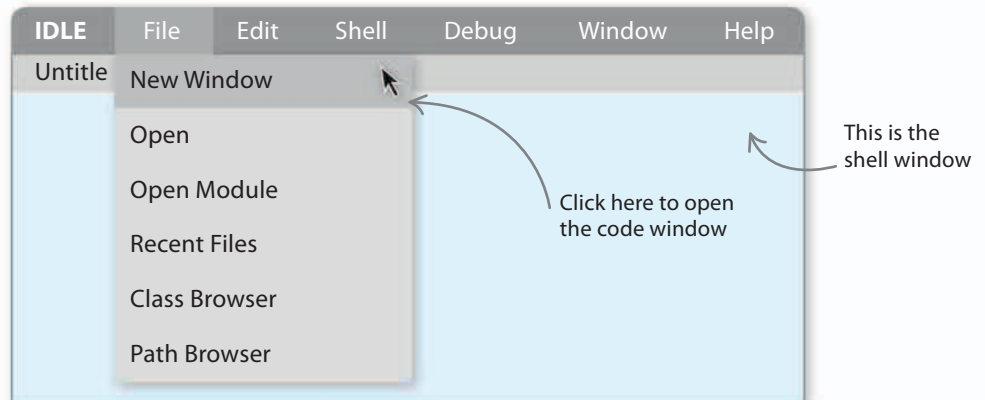

**3 Enter the code**

In the new code window, type in this text. It's an instruction to write the words "Hello World!"

```
print('Hello World!')
```

Use single quote marks

**4 Save the code window**

Click the "File" menu and select "Save As". Enter the file name "HelloWorld" and click "Save".

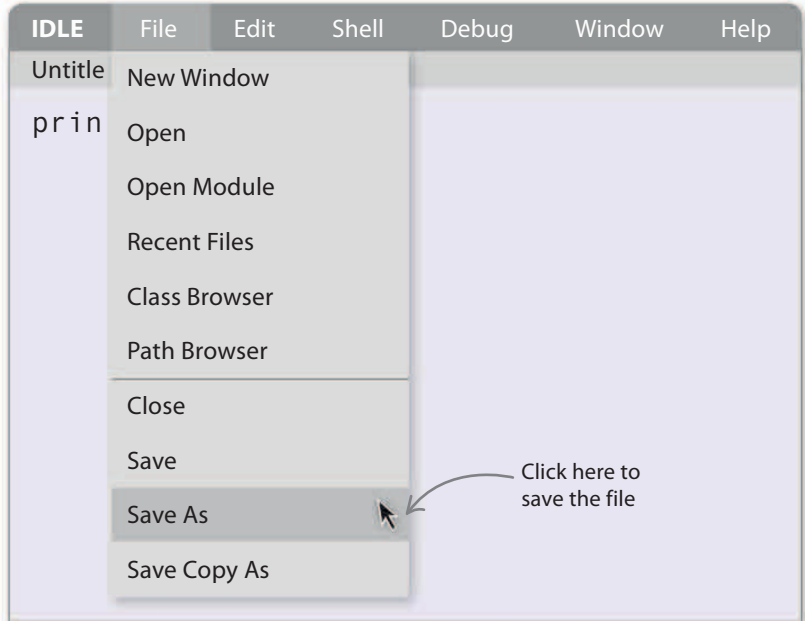
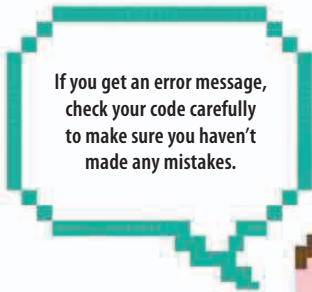
**5 Run the program**

In the code window, click the "Run" menu and select "Run Module". This will run the program in the shell window.

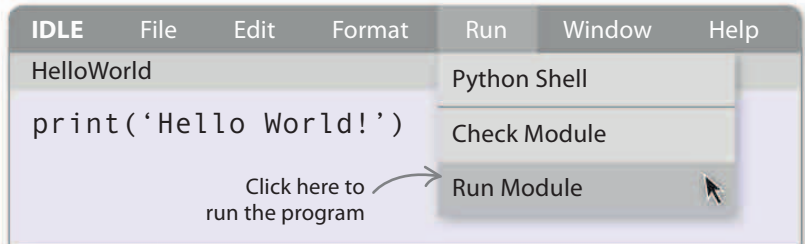
**6 Output in the shell window**

Look at the shell window. The "Hello World!" message should appear when the program runs. You've now created your first bit of code in Python!

```
>>>
Hello World!
>>>
```

The message will appear without quote marks

**REMEMBER****How IDLE works**

Always follow these three steps in IDLE: write the code, save it, and then run it. Remember, code that hasn't been saved won't run. A warning will come up if you try.

Enter code



Save



Run

# Errors

Sometimes programs don't work the first time, but they can always be fixed. When code for a program isn't entered correctly, Python will display an error message telling you what has gone wrong.

## Errors in the code window

When trying to run a program in the code window, you might see a pop-up window appear with an error message (such as "SyntaxError") in it. These errors stop the program from running and need to be fixed.

### 1 Syntax error

If a pop-up window appears with a "SyntaxError" message, it often means there's a spelling mistake or typing error in the code.

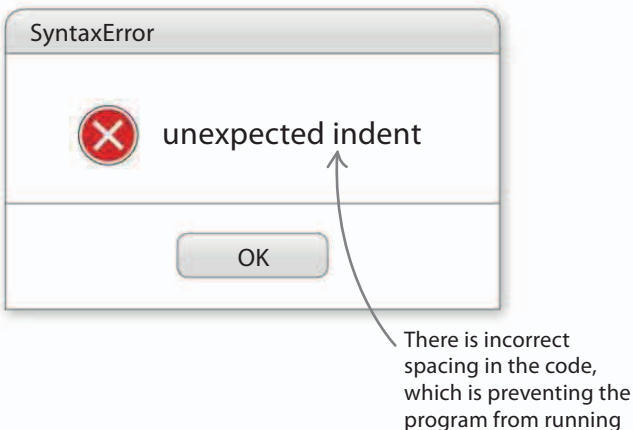
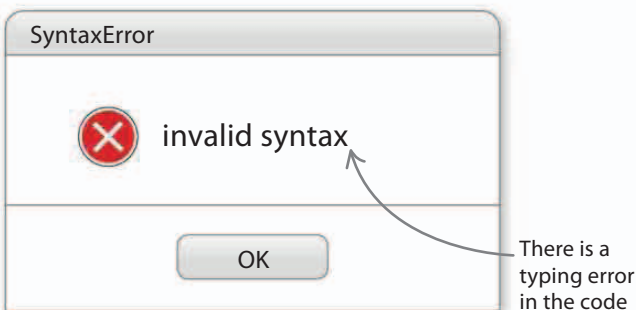

### SEE ALSO

Bugs and debugging **148–149** >

What next? **176–177** >

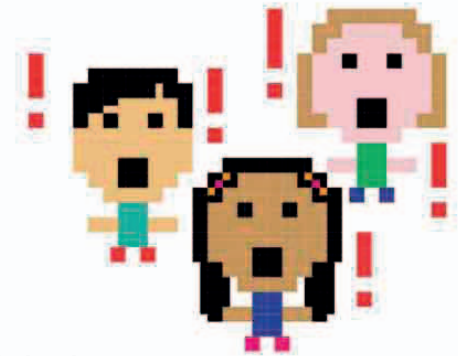

### 2 Error highlighted

Click "OK" in the pop-up window and you'll go back to your program. There will be a red highlight on or near the error. Check that line for mistakes carefully.

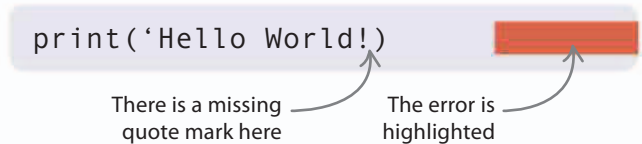

### EXPERT TIPS

#### Classic errors

Some mistakes are particularly easy to make. Keep an eye out for these common problems:

**Upper vs lower case:** The case has to match exactly. If you write "Print" instead of "print", Python won't understand the instruction.

**Single and double quotes:** Don't mix up single and double quotes. All opening quotes need a matching closing quote.

**Minus and underscore:** Don't confuse the minus sign (-) with the underscore sign (\_).

**Different brackets:** Different-shaped brackets, such as (), {}, and [], are used for different things. Use the correct ones, and check there's a complete pair.



## Errors in the shell window

Sometimes, an error message will appear in red text in the shell window. This will also stop the program from working.

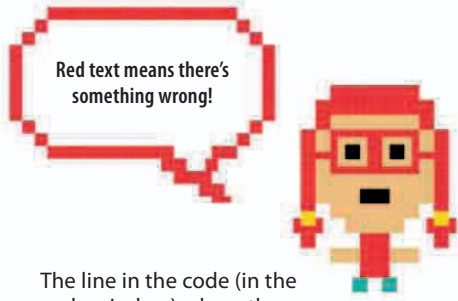

- 1 Name error**  
If the error message "NameError" appears, it means Python can't understand one of the words that has been used. If the error is in code entered in the code window, right-click on the error message in the shell window and select "Go to file/line".

```
>>>
Traceback (most recent call last):
  File "C:\PythonCode\errors.py", line 1, in <module>
    pront('Hello World!')
NameError: name 'pront' is not defined
```

The line in the code (in the code window) where the error was found

The word Python doesn't understand

Click here to highlight the line where the error appears in the code window

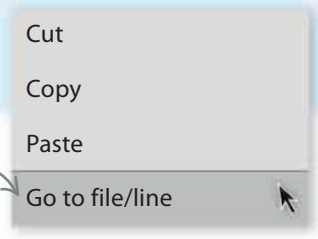

- 2 Fix the error**  
The line with the error is highlighted in the code window. The word "pront" has been typed instead of "print". You can then edit the code to fix the error.

```
pront('Hello World!')
```

Change this to read "print"

## Spotting errors

Use the tips on these two pages to find the line in the code where the errors appear, then double-check that line. Go through the checklist on the right to help you find out what has gone wrong.

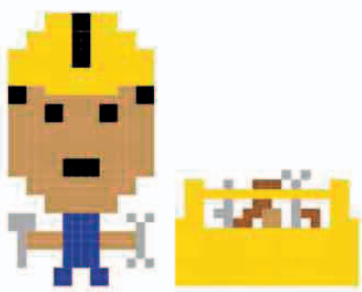

▷ **When things go wrong**  
There are some methods you can use to find errors more easily. Here's a handy checklist.

ERROR BUSTING	
<b>Check your code for the following points</b>	✓
Have you copied exactly what you were asked to enter?	✓
Have you spelled everything correctly?	✓
Are there two quote marks (') around the expression you want to print?	✓
Do you have extra spaces at the beginning of the line? Spacing is very important in Python.	✓
Have you checked the lines above and below the highlighted line? Sometimes that's where the problem is.	✓
Have you asked someone else to check the code against the book? They might spot something you have missed.	✓
Are you using Python 3 not Python 2? Programs for Python 3 don't always work in Python 2.	✓

## PROJECT 4

# Ghost game

This simple game highlights some of the things to watch out for when writing programs in Python. Once the code has been typed in, run the program to play the game. Can you escape the haunted house?

### SEE ALSO

Ghost game **98-99** >  
decoded

Program **100-101** >  
flow



**1** Start IDLE, and use the “File” menu to open a new window. Save the game as “ghost game.” Arrange the windows so you can see them both, then type this into the code window.

These must be underscores, not minus signs

This section needs to be indented by four spaces. If this doesn't happen automatically, check that there is a colon after “feeling\_brave”

This indent will start at eight spaces and needs to be reduced to just four spaces

Delete all indents here

```
# Ghost Game
from random import randint
print('Ghost Game')
feeling_brave = True
score = 0
while feeling_brave:
    ghost_door = randint(1, 3)
    print('Three doors ahead...')
    print('A ghost behind one.')
    print('Which door do you open?')
    door = input('1, 2, or 3?')
    door_num = int(door)
    if door_num == ghost_door:
        print('GHOST!')
        feeling_brave = False
    else:
        print('No ghost!')
        print('You enter the next room.')
        score = score + 1
print('Run away!')
print('Game over! You scored', score)
```

Use single quotes

Only use capital letters where they are shown

Make sure to add a colon here

Use two equals signs here

There should be no quotes around “score” here



- 2** Once the code has been carefully typed in, use the “Run” menu to select “Run Module.” You must save the program first.

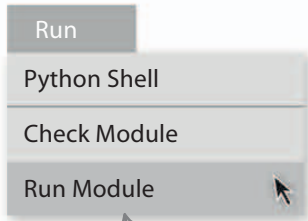

Choose “Run Module” from the “Run” menu in the code window

- 3** The game begins in the shell window. The ghost is hiding behind one of three doors. Which one will you pick? Type 1, 2, or 3 then press “Enter.”

Ghost Game  
Three doors ahead...  
A ghost behind one.  
Which door do you open?  
1, 2, or 3?

Type in your guess

- 4** The aim of the game is to pick a door with no ghost behind it. If this happens, you’ll move to the next room and keep playing the game.

Ghost Game  
Three doors ahead...  
A ghost behind one.  
Which door do you open?  
1, 2, or 3?  
No ghost!

The number you type in appears here

This is what you’ll see if there is no ghost behind the door you choose

- 5** If you’re unlucky you’ll pick a door with a ghost behind it, and the game ends. Run the program again to see if you can beat your last score.

Ghost Game  
Three doors ahead...  
A ghost behind one.  
Which door do you open?  
1, 2, or 3?  
GHOST!  
Run away!  
Game over! You scored 0

This is what appears if the ghost is behind your door

The score shows how many rooms you survived

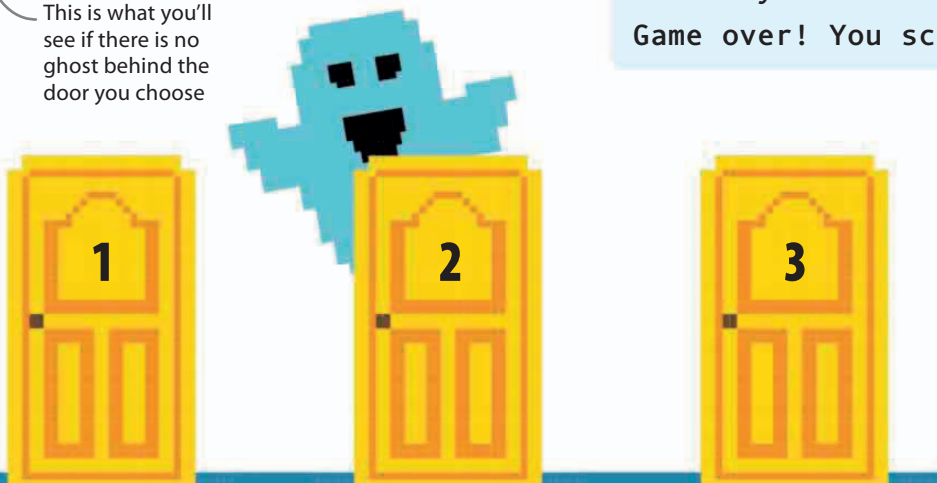

# Ghost game decoded

The ghost game displays some of the key features of Python. You can break down the code to see how the program is structured and what the different parts of it do.

## SEE ALSO

◀ 96–97 Ghost game

Program 100–101 ›  
flow

## Code structure

Python uses spaces at the start of lines to work out which instructions belong together. These spaces are called “indents.” For example, the code after “while feeling\_brave” is indented by four spaces to show it’s all part of the main loop.

```
# Ghost Game
from random import randint
print('Ghost Game')
feeling_brave = True
score = 0
while feeling_brave:
    ghost_door = randint(1, 3)
    print('Three doors ahead...')
    print('A ghost behind one.')
    print('Which door do you open?')
    door = input('1, 2 or 3?')
    door_num = int(door)
    if door_num == ghost_door:
        print('GHOST!')
        feeling_brave = False
    else:
        print('No ghost!')
        print('You enter the next room.')
        score = score + 1
    print('Run away!')
print('Game over! You scored', score)
```

Game setup

The main loop

### ◀ Code key

This diagram shows the structure of the ghost game. The numbered parts are explained in more detail below.

Branching part

Game ending

This is a “comment”. It’s not shown when the game is run

### 1 Game setup

These instructions only run once—at the beginning of the game. They set up the title, variables, and the “randint” command.

```
# Ghost Game
from random import randint
print('Ghost Game')
feeling_brave = True
score = 0
```

This sets up the “randint” command, which generates random numbers

The “print” command displays text when the game is run

This resets the score to 0

## EXPERT TIPS

### Type carefully

When using Python, enter the code very carefully. If you leave out a colon, quotation mark, or parenthesis, the program won’t work properly. You need to match the use of capital letters and spaces exactly too.

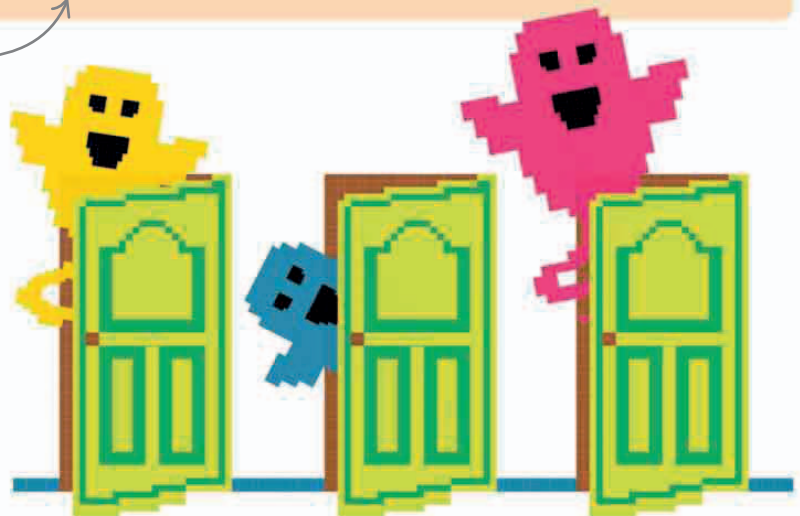

## 2 The main loop

This loop tells the story and receives the player's guess. It keeps on going as long as there isn't a ghost behind the door that's picked. When a ghost appears, the "feeling\_brave" variable changes to "False" and the loop stops repeating.

## 3 Branching part

The program takes a different path depending on whether or not there was a ghost behind the door that was picked. If there was a ghost, the "feeling\_brave" variable is set to "False" but if not, the player's score increases by one.

```
while feeling_brave:
    ghost_door = randint(1, 3)
    print('Three doors ahead...')
    print('A ghost behind one.')
    print('Which door do you open?')
    door = input('1, 2 or 3?')
    door_num = int(door)

    if door_num == ghost_door:
        print('GHOST!')
        feeling_brave = False
    else:
        print('No ghost!')
        print('You enter the next room.')
        score = score + 1
```

This selects a random number between 1 and 3

The "print" command displays the text onscreen

This line asks for the player's answer

This branch runs if there's a ghost behind the door the player picks

If there's no ghost, the player sees this message

## 4 Game ending

This runs just once, when you meet the ghost and the loop ends. Python knows this isn't part of the loop because it's not indented.

```
print('Run away!')
print('Game over! You scored', score)
```

The score is a variable—it will change depending on how many rooms the player gets through

The score increases by one each time the player enters a room without meeting a ghost

This shows a message telling the player to run away from the ghost

## REMEMBER

### Achievements

Congratulations—you've created your first Python game! You'll learn more about these commands later in the book, but you've already achieved a lot:

**Entered a program:** You've typed a program into Python and saved it.

**Run a program:** You've learned how to run a Python program.

**Structured a program:** You've used indents to structure a program.

**Used variables:** You've used variables to store the score.

**Displayed text:** You've displayed messages on the screen.



# Program flow

Before learning more about Python, it's important to understand how programs work. The programming basics learned in Scratch can also be applied to Python.

## SEE ALSO

◀ 30–31 Colored blocks and scripts

Simple 102–103 ›  
commands

Harder 104–105 ›  
commands

## From input to output

A program takes input (information in), processes it (or changes it), and then gives back the results (output). It's a bit like a chef taking ingredients, turning them into cakes, and then giving you the cakes to eat.

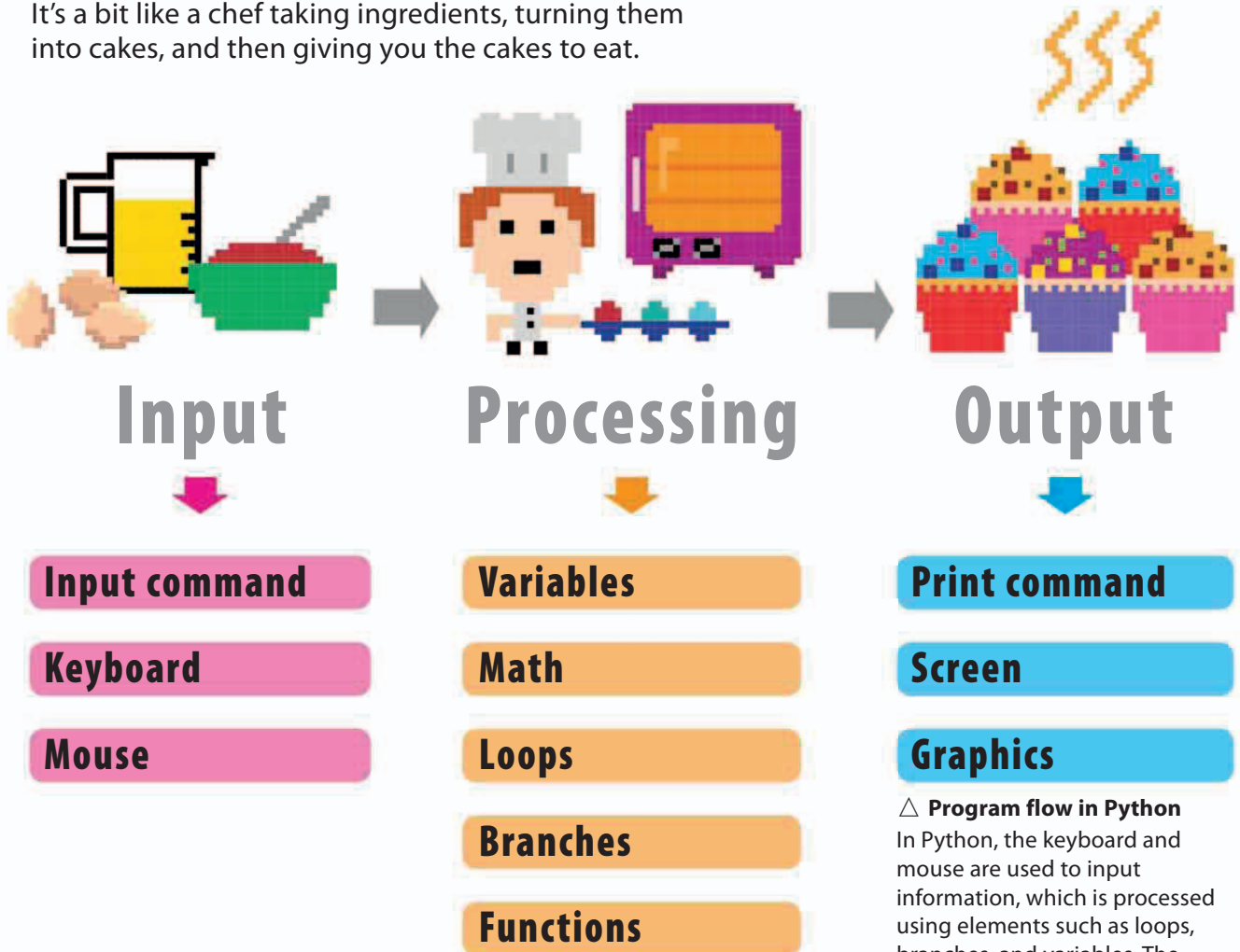

△ **Program flow in Python**  
In Python, the keyboard and mouse are used to input information, which is processed using elements such as loops, branches, and variables. The output is then displayed on the screen.

## Looking at the Ghost game through Scratch goggles

Program flow works the same in most programming languages. Here are some examples of input, processing, and output in Python's Ghost game—and what they might look like in Scratch.

Python and Scratch are more similar than they appear.

### EXPERT TIPS

#### One script at a time

There's an important difference between Scratch and Python. In Scratch, lots of scripts can run at the same time. In Python, however, the program is made up of only one script.

### 1 Input

In Python, the "input()" function takes an input from the keyboard. It's similar to the "ask and wait" block in Scratch.

```
door = input('1, 2 or 3?')
```

The question appears on screen

ask 1, 2 or 3? and wait

"ask and wait" Scratch block

The question in the Scratch block

### 2 Processing

Variables are used to keep track of the score and the function "randint" picks a random door. Different blocks are used to do these things in Scratch.

```
score = 0
```

Sets the variable "score" to 0

set score to 0

"set score to 0" Scratch block

This Scratch block sets the value of the variable "score" to 0

```
ghost_door = randint(1, 3)
```

Selects a random whole number between 1 and 3

pick random 1 to 3

"pick random" Scratch block

This Scratch block selects a random number

### 3 Output

The "print()" function is used to output things in Python, while the "say" block does the same thing in Scratch.

```
print('Ghost game')
```

Displays "Ghost game" on the screen

say Ghost game

"say" Scratch block

Shows a speech bubble containing the words "Ghost game"













# Simple commands

At first glance, Python can look quite scary, especially when compared to Scratch. However, the two languages aren't actually as different as they seem. Here is a guide to the similarities between basic commands in Python and Scratch.





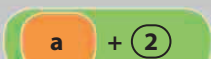
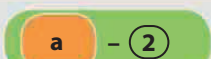

## SEE ALSO

◀ 86–87 What is Python?

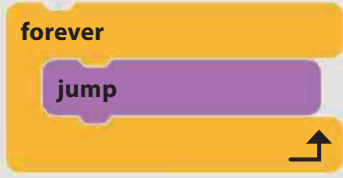
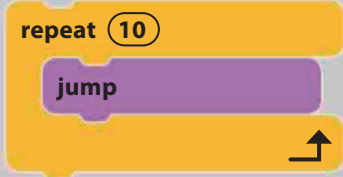
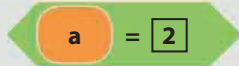
Harder 104–105 ▶  
commands

Command	Python 3	Scratch 2.0
Run program	"Run" menu or press "F5" (in code window)	
Stop program	Press "CTRL-C" (in shell window)	
Write text to screen	<code>print('Hello!')</code>	
Set a variable to a number	<code>magic_number = 42</code>	
Set a variable to a text string	<code>word = 'dragon'</code>	
Read text from keyboard into variable	<code>age = input('age?')</code> <code>print('I am ' + age)</code>	 
Add a number to a variable	<code>cats = cats + 1</code> or <code>cats += 1</code>	
Add	<code>a + 2</code>	
Subtract	<code>a - 2</code>	
Multiply	<code>a * 2</code>	
Divide	<code>a / 2</code>	

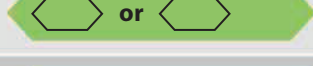

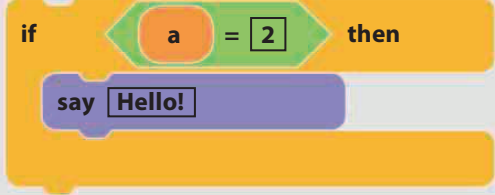
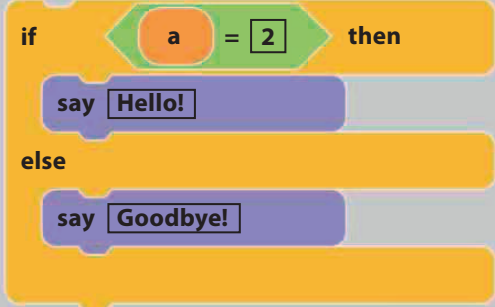
Command	Python 3	Scratch 2.0
Forever loop	<pre>while True:     jump()</pre>	
Loop 10 times	<pre>for i in range (10):     jump()</pre>	
Is equal to?	<code>a == 2</code>	
Is less than?	<code>a &lt; 2</code>	
Is more than?	<code>a &gt; 2</code>	
NOT	<code>not</code>	
OR	<code>or</code>	
AND	<code>and</code>	
If then	<pre>if a == 2:     print('Hello!')</pre>	
If then else	<pre>if a == 2:     print('Hello!') else:     print('Goodbye!')</pre>	







# Harder commands

Python can also be used to do some of the more complicated things that are possible in Scratch: for example, creating complex loops, playing with strings and lists, and drawing pictures with turtle graphics.

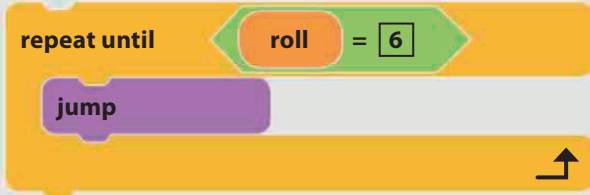
## SEE ALSO

◀ **86–87** What is Python?

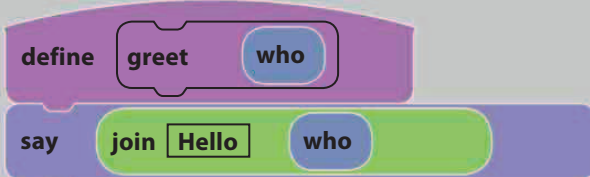
◀ **102–103** Simple commands

Command	Python 3	Scratch 2.0
Loops with conditions	<pre>while roll != 6:     jump()</pre>	
Wait	<pre>from time import sleep sleep(2)</pre>	
Random numbers	<pre>from random import randint roll = randint(1, 6)</pre>	
Define a function or subprogram	<pre>def jump():     print('Jump!')</pre>	
Call a function or subprogram	<pre>jump()</pre>	
Define a function or subprogram with input	<pre>def greet(who):     print('Hello ' + who)</pre>	
Call a function or subprogram	<pre>greet('chicken')</pre>	

Command	Python 3	Scratch 2.0
Turtle graphics	<pre>from turtle import * clear() pendown() forward(100) right(90) penup()</pre>	
Join strings	<pre>print(greeting + name)</pre>	
Get one letter of a string	<pre>name[0]</pre>	
Length of a string	<pre>len(name)</pre>	
Create an empty list	<pre>menu = list()</pre>	
Add an item to end of list	<pre>menu.append(thing)</pre>	
How many items on list?	<pre>len(menu)</pre>	
Value of 5th item on list	<pre>menu[4]</pre>	
Delete 2nd item on list	<pre>del menu[1]</pre>	
Is item on list?	<pre>if 'olives' in menu:     print('Oh no!')</pre>	

# Which window?

There are two different windows to choose from in IDLE. The code window can be used to write and save programs, while the shell window runs Python instructions right away.

## SEE ALSO

◀ 92–93 Introducing IDLE

◀ 96–97 Ghost game

## The code window

So far in this book, the code window has been used to write programs. You enter the program, save it, run it, and the output appears in the shell window.

### ▽ Running programs

This process is used for running Python programs. Programs always have to be saved before running them.

Enter code

Save

Run module

Output

### 1 Enter a program in the code window

Enter this code in the code window, save it, and then click on “Run module” in the “Run” menu to run the program.

```
a = 10
b = 4
print(a + b)
print(a - b)
```

Give “a” the value 10

Give “b” the value 4

The “print” command shows the answers to these sums

### 2 Output in the shell window

When the program runs, its output (the results of the program) is shown in the shell window.

```
>>>
14
6
```

The answers to the sums appear in the shell window

## The shell window

Python can also understand commands that are typed in the shell window. They run as soon as they are typed in, and the result is shown straight away.

```
>>> a = 10
>>> b = 4
>>> a + b
14
>>> a - b
6
```

The first two commands have no output because they are just assigning values to “a” and “b”

Output appears immediately

◀ **Code and output together**

The shell window shows the code and the output together. It’s easier to tell which answer belongs to which sum when the commands are typed in the shell window.



### △ Test your ideas

The shell window gives you an immediate response, which makes it ideal for testing instructions and exploring what they can do.

## Python playground

The shell window can be used to try out all sorts of Python commands, including drawing. The turtle is used to draw on screen in the same way that the pen is used in Scratch.

```
>>> from turtle import *
>>> forward(100)
>>> right(120)
>>> forward(100)
```

Loads all the commands that control the turtle

Enter the code  
Type these instructions in the shell window. They run after each one is typed. As the turtle moves, it draws a line.

Moves the turtle forward

### Turtle graphic

Can you work out how to draw other shapes, such as a square or a pentagon? To start over, type "clear()" into the shell window.

## Which window should you use?

Should you use the code window or the shell window? It depends on the type of program you're writing, and whether it has to be repeated.

### Code window

The code window is ideal for longer pieces of code because they can be saved and edited. It's easier than retyping all the instructions if you want to do the same thing again or try something similar. It needs to be saved and run each time, though.

## Code vs Shell

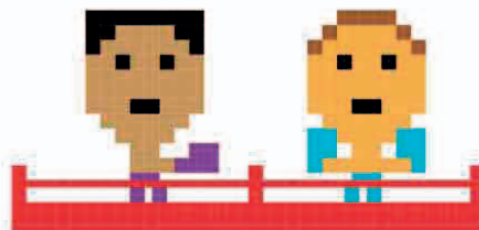

### EXPERT TIPS

## Colors in the code

IDLE color-codes the text. The colors give you some clues about what Python thinks each piece of text is.

- Built-in functions**  
 Commands in Python, such as "print", are shown in purple.
- Strings in quotes**  
 Green indicates strings. If the brackets are green too, there's a missing quote mark.
- Most symbols and names**  
 Most code is shown in black.
- Output**  
 Python's output in the shell window is shown in blue.
- Keywords**  
 Keywords, such as "if" and "else", are orange. Python won't let you use keywords as variable names.
- Errors**  
 Python uses red to alert you to any error messages in the shell window.

### Shell window

The shell window is perfect for quick experiments, such as checking how a command works. It's also a handy calculator. It doesn't save the instructions though, so if you're trying something you might want to repeat, consider using the code window instead.

# Variables in Python

Variables are used to remember pieces of information in a program. They are like boxes where data can be stored and labeled.

## Creating a variable

When a number or string is put into a variable it's called assigning a value to the variable. You use an "=" sign to do this. Try this code in the shell window.

```
>>> bones = 3
```

Variable name → bones  
Value assigned to the variable → 3

### △ Assign a number

To assign a number, type in the variable name, an equals sign, and then the number.

```
>>> dogs_name = 'Bruno'
```

Variable name → dogs\_name  
String assigned to the variable → 'Bruno'

### △ Assign a string

To assign a string, type in the variable name, an equals sign, and then the string in quote marks.

## Printing a variable

The "print" command is used to show something on the screen. It has nothing to do with the printer. You can use it to show the value of a variable.

```
>>> print(bones)
```

3  
Variable name → bones

### △ Number output

The variable "bones" contains the number 3, so that's what the shell window prints.

```
>>> print(dogs_name)
```

Bruno  
No quote marks here

### △ String output

The variable "dogs\_name" contains a string, so the string is printed. No quote marks are shown when you print a string.

## SEE ALSO

Types of data **110–111** >

Math in **112–113** >  
Python

Strings in **114–115** >  
Python

Input and **116–117** >  
output

Functions **130–131** >

## REMEMBER

### Variables in Scratch

The command to assign a variable in Python does the same job as this Scratch block. However, in Python you don't have to click a button to create a variable. Python creates the variable as soon as you assign a value to it.

set bones to 3

Scratch block for giving a value to a variable

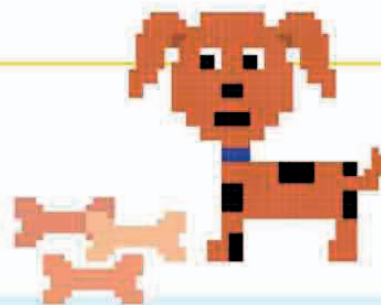

## Changing the contents of a variable

To change the value of a variable, simply assign a new value to it. Here, the variable "gifts" has the value 2. It changes to 3 when it's assigned a new value.

```
>>> gifts = 2
>>> print(gifts)
2
>>> gifts = 3
>>> print(gifts)
3
```

Changes the value of the variable



## Using variables

The value of one variable can be assigned to another one using the "=" sign. For example, if the variable "rabbits" contains the number of rabbits, we can use it to assign the same value to the variable "hats", so that each rabbit has a hat.

**1 Assign the variables**  
This code assigns the number 5 to the variable "rabbits". It then assigns the same value to the variable "hats".

```
>>> rabbits = 5
>>> hats = rabbits
```

Variable name

Value assigned to the variable

"hats" now has the same value as "rabbits"



### EXPERT TIPS

#### Naming variables

There are some rules you have to follow when naming your variables:

- All letters and numbers** can be used. **You can't start** with a number.
- Symbols** such as -, /, #, or @ can't be used.
- Spaces** can't be used.
- An underscore** ( \_ ) can be used instead of a space.
- Uppercase and lowercase** letters are different. Python treats "Dogs" and "dogs" as two different variables.
- Don't use** words Python uses as a command, such as "print".

**2 Print the values**  
To print two variables, put them both in brackets after the "print" command, and put a comma between them. Both "hats" and "rabbits" contain the value 5.

```
>>> print(rabbits, hats)
5 5
```

Leave a space after the comma

**3 Change the value of "rabbits"**  
If you change the value of "rabbits", it doesn't affect the value of "hats". The "hats" variable only changes when you assign it a new value.

```
>>> rabbits = 10
>>> print(rabbits, hats)
10 5
```

Give "rabbits" a new value

Value for "hats" remains the same

# Types of data

There are several different types of data in Python. Most of the time, Python will work out what type is being used, but sometimes you'll need to change data from one type to another.

## SEE ALSO

Maths in **112–113** ›  
Python

Strings in **114–115** ›  
Python

Making **118–119** ›  
decisions

Lists **128–129** ›

## Numbers

Python has two data types for numbers. “Integers” are whole numbers, (numbers without a decimal point). “Floats” are numbers with a decimal point. An integer can be used to count things such as sheep, while a float can be used to measure things such as weight.

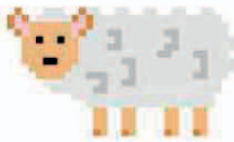

```
>>> sheep = 1
>>> print(sheep)
1
```

An integer  
is a whole  
number

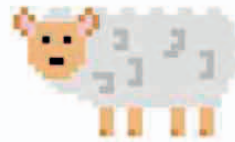

```
>>> sheep = 1.5
>>> print(sheep)
1.5
```

1.5  
is a float

### △ Integers

An integer is a number without a decimal point, such as the 1 in the variable “sheep”.

### △ Floats

A float is a number with a decimal point, such as 1.5. They aren't normally used to count whole objects.

## Strings

Just like in Scratch, a piece of text in Python is called a “string”. Strings can include letters, numbers, spaces, and symbols such as full stops and commas. They are usually put inside single quote marks.

The string  
in quotes

```
>>> a = 'Coding is fun!'
>>> print(a)
Coding is fun!
```

The value of  
the variable “a”  
printed out

Always remember that  
strings need quote  
marks at the start  
and the end.



### ▷ Using a string

To assign a string to a variable, put the text inside single quote marks.



# Booleans

In Python, a Boolean always has a value that is either “True” or “False”. In both cases, the word begins with a capital letter.

▷ **True**  
When the value “True” is put into a variable, it will be a Boolean variable.

```
>>> a = True
>>> print(a)
True
```

No quote marks

Boolean value printed

▷ **False**  
When the value “False” is put into a variable, it will be a Boolean variable too.

```
>>> a = False
>>> print(a)
False
```

Boolean value printed

**EXPERT TIPS**

### Spotting data types

In Python, there are many data types. To find out what data type something is, you can use the “type” command.

```
>>> type(24)
<class 'int'>
>>> type(24.3)
<class 'float'>
>>> type('24')
<class 'str'>
```

“type” command

24 is an integer (“int”)

24.3 is a float (“float”)

'24' is a string (“str”) because it is in quote marks

# Converting data types

Variables can contain any type of data. Problems occur if you try to mix types together. Data types sometimes have to be converted; otherwise, an error message will appear.



▷ **Mixed type**  
The “input” command always gives a string, even if a number is entered. In this example, since “apple” actually contains a string, an error message is displayed.

```
>>> apple = input('Enter number of apples ')
Enter number of apples 2
>>> print(apple + 1)
TypeError
```

Variable name

String in quote marks shown on screen

Tries to add the number 1 to the variable “apple”

The program gives an error message because Python doesn't know how to add a number to a string

▷ **Converting data types**  
To convert the string into a number, the “int()” command is used to turn it into an integer.

```
>>> print(int(apple) + 1)
3
```

The program now works and shows the result

The variable turns from a string into an integer, so a number can be added to it

# Math in Python

Python can be used to solve all sorts of mathematical problems, including addition, subtraction, multiplication, and division. Variables can also be used in sums.

## SEE ALSO

◀ 52–53 Math

◀ 108–109 Variables in Python

## Simple calculations

In Python, simple calculations can be made by typing them into the shell window. The “print()” function is not needed for this—Python gives the answer straight away. Try these examples in the shell window:

```
>>> 12 + 4
16
```

### △ Addition

Use the “+” symbol to add numbers together.

Use the shell window to get instant results

```
>>> 12 - 4
8
```

### △ Subtraction

Use the “-” symbol to subtract the second number from the first one.

The answer appears when you press “Enter”

You can't divide by zero, so you'll always get an error if you try to do so.



```
>>> 12 * 4
48
```

### △ Multiplication

Use the “\*” symbol to multiply two numbers together.

Computers use the “\*” symbol, not “x”, for multiplication

```
>>> 12 / 4
3.0
```

### △ Division

Use the “/” symbol to divide the first number by the second one.

Division in Python gives an answer as a float (a number with a decimal point)

## Using brackets

Brackets can be used to instruct Python which part of a sum to do first. Python will always work out the value of the sum in the bracket, before solving the rest of the problem.

First it works out that  $6 + 5 = 11$ , then 11 is multiplied by 3

```
>>> (6 + 5) * 3
33
```

### △ Addition first

In this sum, brackets are used to instruct Python to do the addition first.

First it works out that  $5 * 3 = 15$ , then 15 is added to 6

```
>>> 6 + (5 * 3)
21
```

### △ Multiplication first

Brackets here are used to do the multiplication first, in order to end up with the correct answer.

Different answer

## Putting answers in variables

If variables are assigned number values, you can use them within sums. When a sum is assigned to a variable, the answer goes into the variable, but not the sum.



### 2 Change the value of a variable

Change the value of the “ants” or “spiders” variable. Add the variables together again and put the answer in the variable “bugs”.

```
>>> ants = 22
>>> spiders = 18
>>> bugs = ants + spiders
>>> print(bugs)
40
```

Change the value in “spiders”

Add the variables together again

The answer changes

### 1 Do a simple addition

This program adds together the variables “ants” and “spiders”, and puts the answer into the variable “bugs”.

```
>>> ants = 22
>>> spiders = 35
>>> bugs = ants + spiders
>>> print(bugs)
57
```

Adds the values of the two variables together

Prints the value in “bugs”



### 3 Skipping the assignment

If the sum is not assigned to the variable “bugs”, even if the value of “ants” and “spiders” changes, the value of “bugs” won’t.

```
>>> ants = 11
>>> spiders = 17
>>> print(bugs)
40
```

Prints the value in “bugs”

The answer hasn’t changed (it’s still 18 + 22)



## Random numbers

To pick a random number, you first need to load the “randint” function into Python. To do this, use the “import” command. The “randint()” function is already programmed with code to pick a random integer (whole number).

```
>>> from random import randint
>>> randint(1, 6)
3
```

Adds the “randint()” function

Picks a random number between 1 and 6

3 has been picked at random

### △ Roll the dice

The “randint()” function picks a random number between the two numbers in the brackets. In this program, “randint(1, 6)” picks a value between 1 and 6.

## REMEMBER

### Random block

The “randint()” function works like the “pick random” block in Scratch. In Scratch, the lowest and highest possible numbers are typed into the windows in the block. In Python, the numbers are put in brackets, separated by a comma.

pick random ① to ⑥

### △ Whole numbers

Both the Python “randint()” function and the Scratch block pick a random whole number—the result is never in decimals.

# Strings in Python

Python is excellent for using words and sentences within programs. Different strings (sequences of characters) can be joined together, or individual parts of them can be selected and pulled out.

## SEE ALSO

◀ 54–55 Strings and lists

◀ 110–111 Types of data

## Creating a string

A string might include letters, numbers, symbols, or spaces. These are all called characters. Strings can be placed in variables.

### ▷ Strings in variables

Variables can store strings. Type these two strings into the variables “a” and “b”.

```
>>> a = 'Run!'
```

```
>>> b = 'Aliens are coming.'
```

The quotation marks indicate the variable contains a string

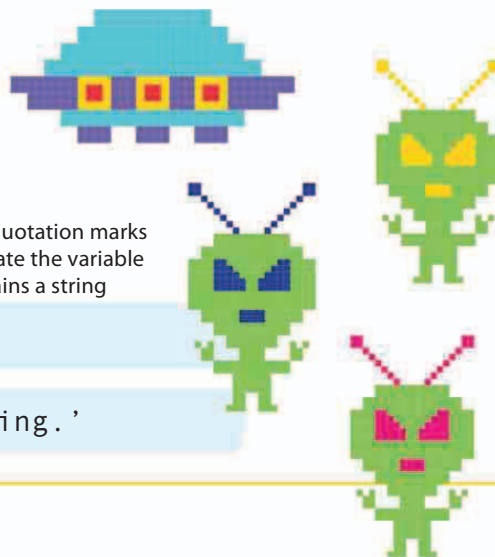

## Adding strings

Adding two numbers together creates a new number. In the same way, when two strings are added together, one string simply joins on to the other one.

```
>>> c = a + b
```

```
>>> print(c)
```

```
Run! Aliens are coming.
```

The variables “a” and “b” combine to become variable “c”

### △ Adding strings together

The “+” symbol joins one string to another, and the answer becomes the variable “c”.

```
>>> c = b + ' Watch out!' + a
```

```
>>> print(c)
```

```
Aliens are coming. Watch out! Run!
```

A new string is added to variable “c”

### △ Adding another string in between

A new string can also be added between two strings. Try the example above.

The new string appears in the middle of the message



## EXPERT TIPS

### Length of a string

The “len()” function is used to find out the length of a string. Python counts all of the characters, including spaces, to give the total number of characters in a string.

Calculates the length of the string in variable “a” (“Run!”)

```
>>> len(a)
```

```
4
```

```
>>> len(b)
```

```
18
```

The string in variable “b” (“Aliens are coming.”) is 18 characters long

## Numbering the characters

Each character in a string is allocated a number according to its position. This position number can be used to look at individual letters or symbols, or to pull them out of a string.

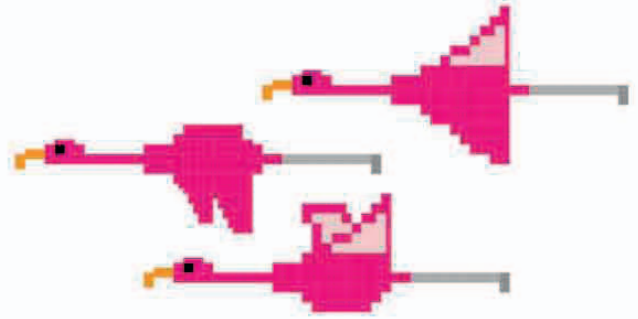

- 1 Count begins from zero**  
When counting the positions, Python starts at 0. The second character is in position 1, the third in position 2, and so on.

```
>>> a = 'FLAMINGO'
```



The sixth letter, "N", is in position 5

0 1 2 3 4 5 6 7

The first character, "F", is in position 0

- 3 "Slicing"**  
Two indexes can be used to pull out a part of the string or "slice" it. The letter in the last position isn't included.

```
>>> a[1:7]
'LAMING'
```

Colon defines the range of characters

A slice from index 1 to index 6 of variable "a"

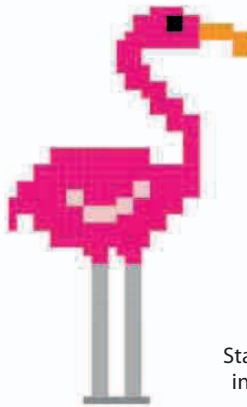

- 2 Counting the characters**  
The position number is called an "index". It can be used to pull out a particular letter from a string.

```
>>> a[3]
'M'
```

Square brackets go around the index

The character in position 3 from the variable "a"

The last character, "O", is in position 7

- 4 From the start or the end**  
If you leave off the start or the end index, Python will automatically use the first or the last character of the string.

```
>>> a[:3]
'FLA'
>>> a[3:]
'MINGO'
```

Starts at index 0

Ends at index 7

## Apostrophes

Strings can go in single or double quotation marks. However, the string should start and end with the same type of quotation mark. This book uses single quotes. But what happens if you want to use an apostrophe in your string?

```
>>> print('It\'s a cloudy day.')
It's a cloudy day.
```

The apostrophe is included in the string

**△ Escaping the apostrophe**  
So Python doesn't read an apostrophe as the end of the string, type a "\" before it. This is called "escaping" it.

# Input and output

Programs interact with users through input and output. Information can be input into a program using a keyboard. Output is shown as information printed on the screen.

## SEE ALSO

◀ **100–101** Program flow

◀ **110–111** Types of data

Loops **122–123** ▶  
in Python

## Input

The “input()” function is used to accept input from the keyboard into a program. It waits until the user finishes typing and presses the “return” or “Enter” key.

- 1 Using input**  
A program can prompt the user what to type. The message is put inside the brackets of “input()”.

```
name = input('Enter your name: ')
print('Hello', name)
```

Adding a space after the colon makes the output look tidier

What the program outputs depends on what name the user types

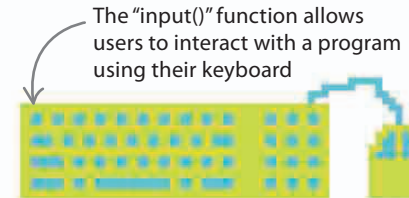

The “input()” function allows users to interact with a program using their keyboard

- 2 Output in the shell window**  
When the program is run, the message “Enter your name: ” and its response appear in the shell window.

```
Enter your name: Jina
Hello Jina
```

Program outputs message

User types in their name

## Output

The “print()” function is used to display characters in the shell window. It can be used to show a combination of text and variables.

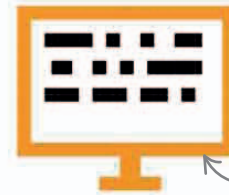

Output is displayed on the screen

- 1 Create some variables**  
Set up three variables for this simple experiment. Two are strings and one is an integer (whole number).

```
>>> a = 'Dave'
>>> b = 'is'
>>> c = 12
```

Quote marks show these are strings

No quote marks as this is an integer

- 2 Using the “print()” function**  
You can put several items inside the brackets of the “print()” function. You can combine variables of different types, and even combine strings and variables.

```
>>> print(a, b, c)
Dave is 12
>>> print('Goodbye', a)
Goodbye Dave
```

Comma separates the different items

## Two ways to separate strings

So far, the output has been printed on one line with a space between the items. Here are two other ways of separating strings.

```
>>> print(a, b, c, sep='-')
Dave-is-12
```

### △ Hyphenate the outputs

A hyphen can be put between the variables when they're printed. Other characters, such as "+" or "\*", can be used too.

The character between the outputs

```
>>> print(a, b, c, sep='\n')
Dave
is
12
```

### △ Outputs on new lines

The space or character between the outputs is called a "separator" ("sep"). Using "\n" prints each output on a new line.

The separator

Each variable starts on a new line

## Three ways to end output

There are several different ways you can signal the end of the output of a "print" function.

```
>>> print(a, '.')
Dave .

>>> print(a, end='.')
Dave.
```

### △ Add a period to the output

A period can be added as another string to be printed, but it will print with a space before it. To avoid this, use "end='.'" instead.

Period added as a string

Period added as an "end" character

**EXPERT TIPS**

### Options at the end

The "end" and "sep" labels tell Python that the next item in the program isn't just another string. Remember to use them; otherwise, the program will not work correctly.



```
>>> for n in range(3):
    print('Hurray!' end=' ')
Hurray! Hurray! Hurray!
```

### △ Output on one line

Usually, each new "print" command starts on a new line. To get the output all on one line use a space as the "end" character.

Space as "end" character

Output is all printed on one line

```
>>> print(a, end='\n\n\n\n')
Dave

>>>
```

### △ Blank lines at the end

Using "\n" starts each output from a new line. Several of them can be used together to add blank lines at the end of a program.

Each "\n" starts a new line

Blank space before the prompt

# Making decisions

Programs make decisions about what to do by comparing variables, numbers, and strings using Boolean expressions. These give an answer of either “True” or “False”.

## SEE ALSO

◀ 62–63 True or false?

◀ 108–109 Variables in Python

## Logical operators

Logical operators are used to compare variables against numbers or strings, or even against other variables. The resulting answer is either “True” or “False”.

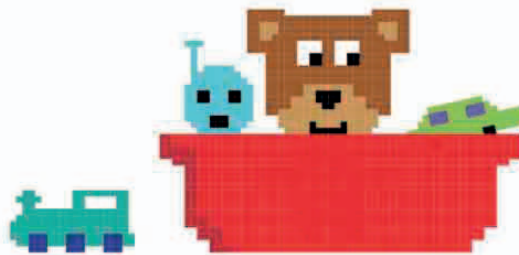

==

“Equals” operator

!=

“Not equal to” operator

<

“Less than” operator

>

“Greater than” operator

<=

“Less than or equal to” operator

>=

“Greater than or equal to” operator

### △ Types of comparison operators

There are six comparison operators. Python uses two equals signs to compare if two things are the same. (A single equals sign is used to assign a value to a variable.)

### ▷ Use the shell to check

Logical operators also work in the shell window. Use this example to try out several logical operators, including “not”, “or”, and “and”.

```
>>> toys = 10
>>> toys == 1
False
>>> toys > 1
True
>>> toys < 1
False
>>> toys != 1
True
>>> toys <= 10
True
>>> not toys == 1
True
>>> toys == 9 or toys == 10
True
>>> toys == 9 and toys == 10
False
```

This checks whether “toys” is equal to 1

This checks whether “toys” is more than 1

This checks whether “toys” is less than 1

This checks if “toys” is not equal to 1

This checks if “toys” is less than or equal to 10

The “not” logical operator reverses the answer (in this example, from “False” to “True”)

The “or” logical operator checks if “toys” is 9 or 10

The “and” logical operator is used to check if “toys” is both 9 and 10. This can never be true, so the answer is “False”



## Is it Ella's birthday?

Ella's birthday is July 28th. This program takes a day and a month and uses logical operators to check whether it's Ella's birthday.

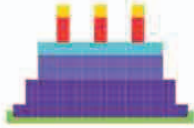

### 1 Check for the birthday

Create variables for a day and a month. Use the "and" logical operator to check whether it is July 28th.

```
>>> day = 28
>>> month = 7
>>> day == 28 and month == 7
True
```

The "and" operator checks to see if both conditions are true

Remember to use two equals signs

It's Ella's birthday!

### 2 Not the birthday detector

You can reverse the answer using the "not" logical operator. You will get the answer "True" on every day, except for Ella's birthday.

```
>>> day = 28
>>> month = 7
>>> not (day == 28 and month == 7)
False
```

This character is used to make code go over two lines

It's Ella's birthday, so the answer is "False"

### 3 Birthday or New Year's Day?

Use the "or" logical operator to check whether it's Ella's birthday or New Year's Day. Use brackets to combine the correct days and months.

```
>>> day = 28
>>> month = 7
>>> (day == 28 and month == 7) \
or (day == 1 and month == 1)
True
```

Checks for the 28th of July

The answer will be "True" if it's Ella's birthday or New Year's Day

## Strings

Two strings can be compared using the "==" operator or the "!=" operator. Strings have to match exactly to get a "True" output.

```
>>> dog = 'Woof woof'
>>> dog == 'Woof woof'
True
>>> dog == 'woof woof'
False
>>> dog == 'Woof woof '
False
```

The strings match exactly, so the answer is "True"

The strings don't match because there isn't a capital "W"

The strings don't match because there's extra space before the quotation mark

### △ Exactly the same

Strings must match for them to be equal. That means they must use capital letters, spaces, and symbols in exactly the same way.



### EXPERT TIPS

## Operator for strings

The "in" operator can be used to see whether one string is inside another string. Use it to check if a string contains a particular letter or a group of letters.

This checks whether "a" is in "abc"

```
>>> 'a' in 'abc'
True
>>> 'd' in 'abc'
False
```

"d" is not in "abc", so the answer is "False"

# Branching

Boolean expressions can be used to determine which route a program should follow, depending on whether the answer to the expression is “True” or “False”. This is known as “branching”.

## SEE ALSO

◀ 64–65 Decisions and branches

◀ 118–119 Making decisions

## Do or do not

The “if” command means that if a condition is “True”, then the program runs a block of commands. If the condition isn’t “True”, the block is skipped. The block after the “if” command is always indented by four spaces.

### 1 “if” condition

This code asks the user if it’s their birthday. It checks whether the answer is “y”. If so, a birthday message is printed.

Indented by four spaces

```
ans = input('Is it your birthday? (y/n)')
if ans == 'y':
    print('Happy Birthday!')
```

Prompts users what to type in

This part of the program only runs if the user types “y”

### 2 Output if condition is “True”

Run the program and enter “y”. The message is printed. It doesn’t appear if anything else is entered.

Type in “y”

```
Is it your birthday? (y/n)y
Happy Birthday!
```

The message appears

## Do this or that

The “if” command can be combined with an “else” command. This combination means that if something is “True”, one thing happens, and if not, something else happens.



### 1 “if-else” condition

If “y” is entered, the program prints a special message for New Year. It shows a different message if anything else is entered.

Remember to put a colon here too

```
ans = input('Is it New Year? (y/n)')
if ans == 'y':
    print('Happy New Year!')
    print('Time for Fireworks.')
else:
    print('Not yet!')
```

Remember the colon

This message only appears if the user enters “y”

Only runs if user does not enter “y”

**2 Output if condition is "True"**

Run the program and type in "y". The program shows your New Year message. It doesn't show the other message.

```
Is it New Year? (y/n)y
Happy New Year!
Time for Fireworks.
```

Type in "y"

**3 "else" condition output**

Type in "n", or any other character, and the New Year message isn't shown. Instead, the "Not yet!" message appears.

```
Is it New Year? (y/n)n
Not yet!
```

Type in "n"

A different message appears

**Do one of these things**

The "elif" command is short for "else-if". It means that if something is "True", do one thing; otherwise, check if something else is "True" and do something else if it is. The following calculator program uses the "elif" command.

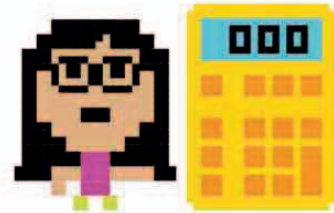
**1 "if-elif-else" condition**

This program checks what is typed in. If it's "add", "sub", "mul", or "div", the result of the sum is shown.

```
a = int(input('a = '))
b = int(input('b = '))
op = input('add/sub/mul/div:')
if op == 'add':
    c = a + b
elif op == 'sub':
    c = a - b
elif op == 'mul':
    c = a * b
elif op == 'div':
    c = a / b
else:
    c = 'Error'
print('Answer = ', c)
```

Asks the user to input a number

Remember to add quote marks and brackets

Type "add" to add the variables together

Type "div" to divide the variables

Shows an error message in "c" if something else is typed in

Shows the answer or error message

**2 Output for the condition that's "True"**

Test the program. Enter two numbers and type in "sub". The answer will be the first number minus the second number.

```
a = 7
b = 5
add/sub/mul/div:sub
Answer = 2
```

Enter two numbers

Type in "sub" to subtract 5 from 7

Answer is calculated by subtracting variable "a" from variable "b"

**3 "else" condition output**

The "else" condition runs if something other than "add", "sub", "mul", or "div" is typed in, and an error message is displayed.

```
a = 7
b = 5
add/sub/mul/div:try
Answer = Error
```

Type something different here

Error message displays

# Loops in Python

Programs that contain repeating lines of code can be time-consuming to type in and difficult to understand. A clearer way of writing them is by using a loop command. The simplest loops are ones that repeat a certain number of times, such as “for” loops.

## SEE ALSO

◀ 48–49 Pens and turtles

While loops 124–125 ▶

Escaping 126–127 ▶ loops

## Repeating things

A “for” loop repeats the code without having to type it in again. It can be used to repeat something a certain number of times, for example, if you want to print the names of a class of 30 students.

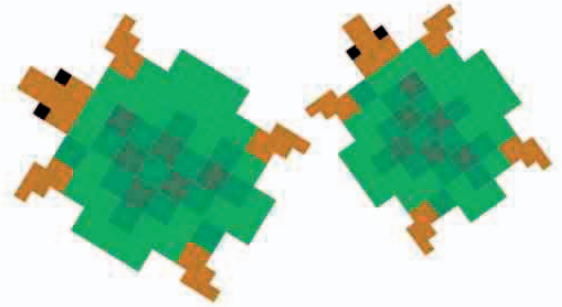

### 1 Program the turtle

A “for” loop can also be used to shorten the code. This program allows the user to control a turtle that draws a line as it moves around the screen. The user can draw shapes on the screen, such as a triangle, by directing the turtle’s movements.



This makes the turtle turn 120 degrees to the right

```
from turtle import *
forward(100)
right(120)
forward(100)
right(120)
forward(100)
right(120)
```

Loads all the commands that control the turtle

This command moves the turtle forward

### 2 The turtle draws a triangle

The program tells the turtle how to draw a triangle by giving it the length of the three sides and the angles between them. The turtle will appear in a separate window when you run the program.

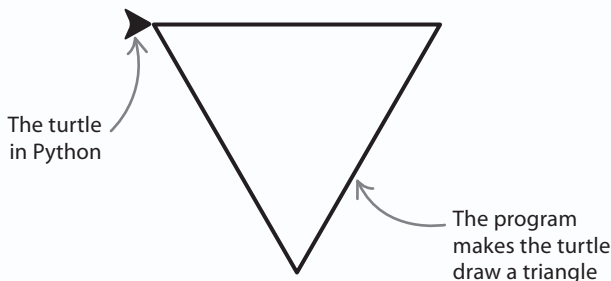

### 3 Use a “for” loop

The program above gives the turtle the same two commands, “forward(100)” and “right(120)”, three times – once for each side of the triangle. An alternative to this is to use these two commands inside a “for” loop. Try drawing a triangle simply using the code shown below.

```
for i in range(3):
    forward(100)
    right(120)
```

The “for” loop tells the program to repeat the instructions three times

The block of instructions in a loop is indented by four spaces

## Loop variables

A loop variable counts the number of times a loop has repeated itself. It starts at the first value in the range (0) and stops one before the last value.

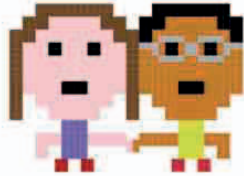

The loop variable

The loop repeats ten times

```
for i in range(10):
    print(i, end=' ')
```

Python stops counting one before the last value

```
>>> 0 1 2 3 4 5 6 7 8 9
```

### △ Simple loop variable

Here, the loop's range doesn't state what the starting value should be. So Python starts counting from 0, the same way as it does with strings.

This tells the program to count in twos

```
for i in range(2, 11, 2):
    print(i, end=' ')
```

```
>>> 2 4 6 8 10
```

The output appears in twos

### △ Counting in twos

This loop has a third value in its range, which tells the loop to count in twos. It stops at 10, which is one loop before the loop variable gets to 11.

This tells the program to count backward

```
for i in range(10, 0, -1):
    print(i, end=' ')
```

```
>>> 10 9 8 7 6 5 4 3 2 1
```

### △ Counting backward

This time the program counts backward from 10, like in a rocket launch. The loop variable starts at 10 and takes steps of -1 until it reaches 1.

## Nested Loops

Loops inside a loop are called "nested loops". In nested loops, the outer loop only repeats after the inner loop has gone round its required number of times.

To make the loops repeat "n" number of times, the last number in the range must be "n + 1"

```
n = 3
for a in range(1, n + 1):
    for b in range(1, n + 1):
        print(b, 'x', a, '=', b * a)
```

The value of "b"

The value of "a"

```
>>>
```

```
1 x 1 = 1
2 x 1 = 2
3 x 1 = 3
1 x 2 = 2
2 x 2 = 4
3 x 2 = 6
1 x 3 = 3
2 x 3 = 6
3 x 3 = 9
```

First time around the outer loop (the inner loop repeats three times)

Second time around the outer loop

Third time around the outer loop

Outer loop

Inner loop

This sum will be printed nine times

### △ Loops inside a loop

In this example, each time the outer loop goes around once, the inner loop goes around three times. So in total, the outer loop is executed three times and the inner loop is executed nine times.

### △ What happens

The nested loops print the first three lines of the 1, 2, and 3 times tables. The value of "a" only changes when the outer loop repeats. The value of "b" counts from 1 to 3 for each value of "a".

# While loops

“For” loops are useful when you know how many times a task needs to be repeated. But sometimes you’ll need a loop to keep repeating until something changes. A “while” loop keeps on going around as many times as it needs to.

## While loops

A while loop keeps repeating as long as a certain condition is true. This condition is called the “loop condition” and is either true or false.

### 1 Create a while loop

Set the starting value of the “answer” variable in the loop condition. The loop condition has to be true to start with or the program will never run the loop.

The code inside the loop must be indented four spaces

```
answer = 'y'
while answer == 'y':
    print('Stay very still')
    answer = input('Is the monster friendly? (y/n)')
print('Run away!')
```

The “answer” variable is set to “y”

The while loop only runs if the condition is true

If the condition is false, unindented code after the loop runs and a different message appears

### 2 What the program looks like

The value entered is stored in the variable “answer”. The loop condition is “answer == ‘y’”. If you type “y”, the loop keeps going. If you type “n”, the loop stops.



```
>>>
Stay very still
Is the monster friendly? (y/n)y
Stay very still
Is the monster friendly? (y/n)y
Stay very still
Is the monster friendly? (y/n)n
Run away!
```

Answer is “y”, so the loop keeps running

Answer is “n”, so the loop ends and a new message appears

### SEE ALSO

◀ 118–119 Making decisions

◀ 122–123 Loops in Python

Escaping 126–127 ▶ loops

### ▶ How it works

A while loop checks if the condition is true. If it is, it goes around the loop again. If it’s not, it skips the loop.

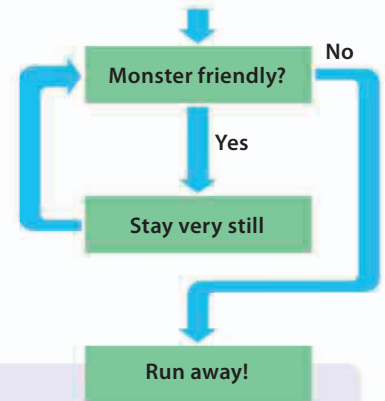

### REMEMBER

## “repeat until” block

Python’s “while” loop is similar to the “repeat until” block in Scratch. Both keep on repeating until something different happens in the program.

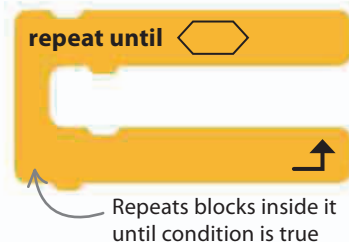

## Forever loops

Some loops run forever. If you set the condition in a “while” loop to be “True”, it can never be false and the loop will never end. This can either be useful or very annoying.

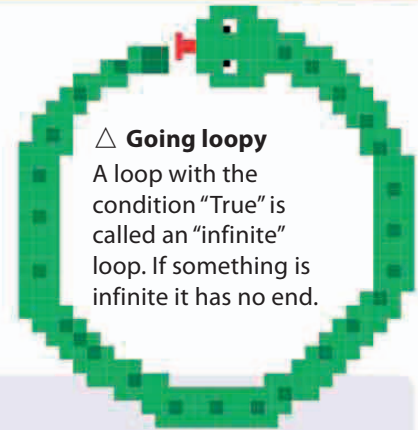

### 1 Create a forever loop

The loop condition here is set to “True”. Nothing that happens inside the loop will make “True” equal anything but “True”, so the loop runs forever.

The typed word is stored in the variable “answer”

```
while True:
    answer = input('Type a word and press enter: ')
    print('Please do not type \'' + answer + '\' again.')
```

The loop is always “True” so will never end

### 2 What the program looks like

On the opposite page the monster program’s loop condition checked to see what the user’s answer was. If the answer isn’t “y”, the loop will stop. The loop shown above doesn’t check the answer, so the user can’t make it stop.

```
>>>
Type a word and press enter: tree
Please do not type 'tree' again
Type a word and press enter: hippo
Please do not type 'hippo' again
Type a word and press enter: water
Please do not type 'water': again
Type a word and press enter
```

No matter what is typed, this loop just keeps on going

### REMEMBER

#### “forever” block

Remember the “forever” block in Scratch? It repeats the code inside it until the red stop button is clicked. A “while True” loop does exactly the same thing. It can be used to make a program keep doing something, such as asking questions or printing a number, as long as the program is running.

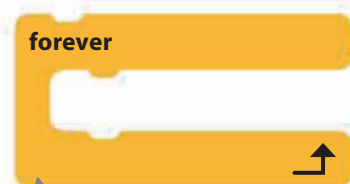

The “forever” block keeps the sprite moving endlessly

### EXPERT TIPS

#### Stop the loop

If you get stuck in an infinite loop, you can stop it from IDLE. Click in the Python shell window, then hold down the “CTRL” key and press the “C” key. This asks IDLE to stop the program. You might have to press “CTRL-C” a few times. This is similar to clicking the red stop button in Scratch.

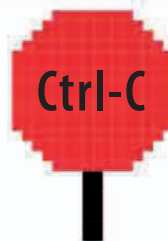

# Escaping loops

Programs can get stuck in a loop, but there are ways to escape. The word “break” leaves a loop (even a “forever” loop), and the word “continue” skips back to the start of the next loop.

## SEE ALSO

◀ 122–123 Loops in Python

◀ 124–125 While loops

## Inserting breaks

Putting a break into a loop makes the program jump out of the loop at once—even if the loop condition is true. Any commands inside the loop that come after the break are ignored.

### 1 Write a simple program

This program tests the user on the 7 multiplication table. The program continues looping until all 12 questions are answered. Write this program in the code window because it will be edited later.

### 2 Insert a “break”

A “break” can be added so the user can escape the loop. The program executes a break if the user types “stop”.

If “guess” equals “stop”, the program skips the rest of the loop and prints “Finished”



```
table = 7
for i in range(1, 13):
    print('What\'s', i, 'x', table, '?')
    guess = input()
    ans = i * table
    if int(guess) == ans:
        print('Correct!')
    else:
        print('No, it\'s', ans)
print('Finished')
```

The variable “i” will count from 1 to 12

“i” is the loop variable

The backslash (“\”) tells Python the next quote mark is an apostrophe, not the end of the string

```
table = 7
for i in range(1,13):
    print('What\'s', i, 'x', table, '?')
    guess = input()
    if guess == 'stop':
        break
    ans = i * table
    if int(guess) == ans:
        print('Correct!')
    else:
        print('No, it\'s', ans)
print('Finished')
```

The “ans” variable holds the correct answer to the question



```
>>>
What's 1 x 7 ?
1
No, it's 7
What's 2 x 7 ?
14
Correct!
What's 3 x 7 ?
stop
Finished
```

The first time around the loop "i" is equal to 1

The value of "i" changes to 2 next time around the loop

This executes the break command and the program exits the loop

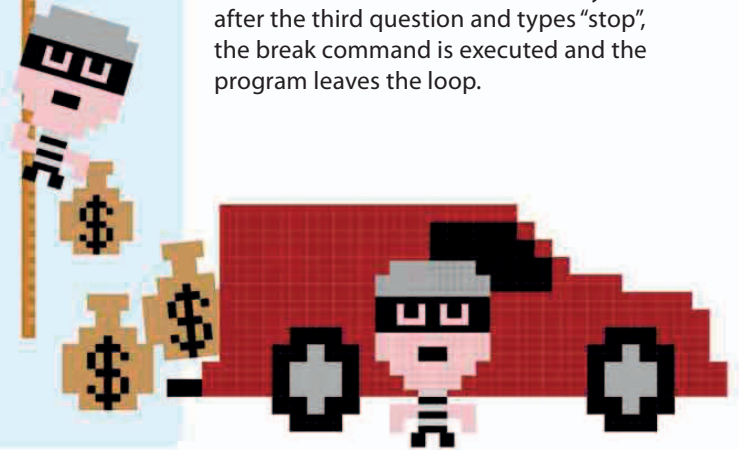

**3 How it works**  
If the user decides not to carry on after the third question and types "stop", the break command is executed and the program leaves the loop.

## Skipping

The "continue" keyword can be used to skip a question without leaving the loop. It tells the program to ignore the rest of the code inside the loop and skip straight to the start of the next loop.

```
table = 7
for i in range(1,13):
    print('What\'s', i, 'x', table, '?')
    guess = input()
    if guess == 'stop':
        break
    if guess == 'skip':
        print('Skipping')
        continue
    ans = i * table
    if int(guess) == ans:
        print('Correct!')
    else:
        print('No, it\'s', ans)
print('Finished')
```

Asks the question "What's 1 x 7?" first time around the loop

Skips straight to the next loop

**4 Insert a continue**  
Add an "if" statement inside the loop to see if the user answered "skip". If so, the program will print "Skipping" and execute a "continue" to skip to the next go around the loop.

**5 What happens**  
If the user doesn't want to answer a question, he or she can type "skip" and continue to the next question.

```
>>>
What's 1 x 7 ?
skip
Skipping
What's 2 x 7 ?
14
Correct!
What's 3 x 7 ?
```

Type "skip" to go to the next question

The loop goes around again as normal when the answer is correct

# Lists

If you need to keep lots of data in one place, then you can put it in a list. Lists can contain numbers, strings, other lists, or a combination of all these things.

## SEE ALSO

◀ 54–55 Strings and lists

Silly 132–133 ▶  
sentences

## What is a list?

A list is a structure in Python where items are kept in order. Each entry is given a number that you can use to refer back to it. You can change, delete, or add to the items in a list at any point.

### ▽ Looking at lists

Each item in a list sits inside single quote marks, and is separated from the next item by a comma. The whole list sits inside a pair of square brackets.

```
>>> mylist = ['apple', 'milk', 'cheese', 'icecream', 'lemonade', 'tea']
```

The list is stored in the variable "mylist"

The items in a list are separated by commas

This character is used to make code go over two lines

The items in the list sit inside a pair of square brackets

### ▷ How it works

You can think of a list as a row of shelves in a kitchen. Each shelf holds one item from the list. To make changes to an item, you must refer to the shelf it is on.

To get to an item on the list, you must go to the right shelf

The position of an item in a list is called its "index"

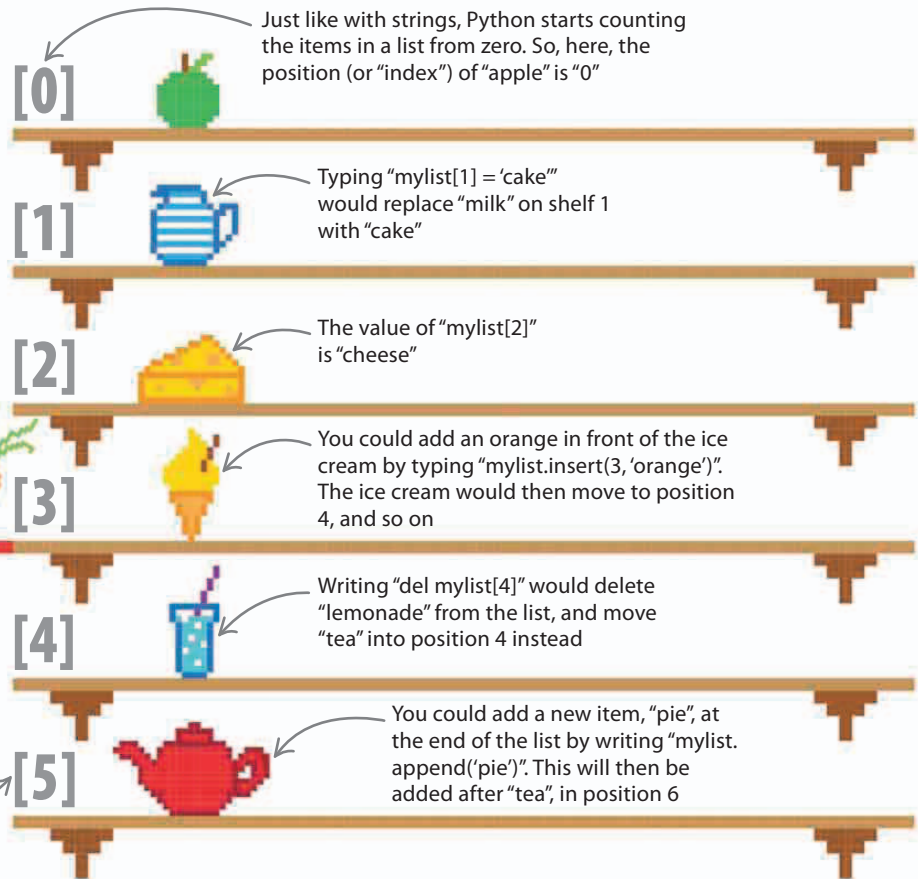

## Using lists

Once a list has been created, you can write programs to manipulate the data inside it—in a loop, for example. You can also combine lists to make new lists.

```
>>> names = ['Simon', 'Kate', 'Vanya']
>>> for item in names:
    print('Hello', item)
```

The list is stored in the variable "names"  
 The body of the loop must be indented by four spaces  
 When run, this program displays "Hello," followed by each name on the list

Hello Simon  
 Hello Kate  
 Hello Vanya

```
x = [1, 2, 3, 4]
y = [5, 6, 7, 8]
z = x + y
print(z)
z = [1, 2, 3, 4, 5, 6, 7, 8]
```

Remember, lists are contained within square brackets  
 This adds the lists together  
 The new list contains everything from list "x" followed by everything from list "y"

### ▽ Lists in lists

The items in a list can be lists themselves. The "suitcase" list below contains two lists of clothes—it is like a suitcase shared by two people, where they each pack three items.

Because the list is inside square brackets, it becomes an individual item within the "suitcase" list—"suitcase[0]"

"suitcase[1]"

```
>>> suitcase=[['hat', 'tie', 'sock'], ['bag', 'shoe', 'shirt']]
>>> print(suitcase)
[['hat', 'tie', 'sock'], ['bag', 'shoe', 'shirt']]
>>> print(suitcase[1])
['bag', 'shoe', 'shirt']
>>> print(suitcase[1][2])
shirt
```

This will print the whole suitcase list  
 This will print everything in the second list, "suitcase[1]"  
 This prints the item at index 2 in "suitcase[1]"—remember, Python starts counting the items from zero



LINGO

## Mutable objects

Lists in Python are "mutable". This means that they can change. You can add or delete items, or switch around their order. Other functions in Python, such as tuples (see pp.134–135), can't be altered once you create them. These are called "immutable".

### ◁ Lists in loops

You can use a loop to work through every item in a list. This program says "Hello" to a series of names, one after the other.

### ◁ Adding lists

Two lists can be added together. The new list will contain the items from both of the old lists.

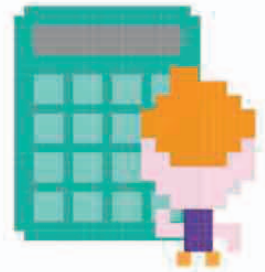

# Functions

A function is a piece of code that performs a specific task. It bundles up the code, gives it a name, and can be used any time by “calling” it. A function can be used to avoid entering the same lines of code more than once.

## SEE ALSO

Silly **132–133** ›  
sentences

Variables and **138–139** ›  
functions

## Useful functions

Python contains lots of useful functions for performing certain tasks. When a function is called, Python retrieves the code for that function and then runs it. When the function is finished, the program returns to the line of code that called it and runs the next command.

### print()

#### △ “print()” function

This function lets the program send output to the user by printing instructions or results on the screen.

### input()

#### △ “input()” function

This function is the opposite of the “print()” function. It lets the user give instructions or data to the program by typing them in.

### randint()

#### △ “randint()” function

This function gives a random number (like throwing a dice). It can be used to add an element of chance to programs.

## Making and calling functions

The functions that come with Python aren’t the only ones that can be used. To make a new function, collect the code you want to use in a special “wrapper” and give it a name. This name allows the function to be called whenever it is needed.



### 1 Define a function

The definition of a function will always have the keyword “def” and the function’s name at the beginning of the code.

```
def greeting():
    print('Hello!')
```

A colon marks the end of the function’s name and the start of the code it contains

This is the code within the function

### 2 Call the function

Typing the function name followed by parentheses into the shell window calls the function and shows the output.

```
>>> greeting()
Hello!
```

The “greeting” function is called and the output is displayed

Parentheses show that this is a function call, not a variable

## Passing data to functions

A function has to be told which values to work with. For example, in “print(a, b, c)”, the function “print()” is being passed the values “a”, “b”, and “c”. In “height(1, 45)”, the values 1 and 45 are being passed to the function “height”.

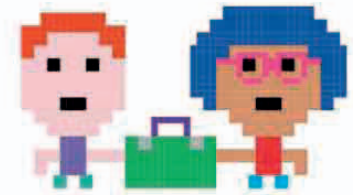

### 1 Add parameters to the function

Values passed to a function are called “parameters”. Parameters are put inside the parentheses next to the function’s name in its definition.

```
def height(m, cm):
    total = (100 * m) + cm
    print(total, 'cm tall')
```

“m” and “cm” are the parameters

Prints the value of “total” followed by “cm tall”

To work out the total in “cm”, the value of “m” needs to be multiplied by 100 (because 1 m = 100 cm)

### 2 Values are defined

The code inside the function uses the values that are passed to it.

Calls the function to give the answer when “m” = 1 and “cm” = 45

```
>>> height(1, 45)
145 cm tall
```

Shows that 1 m 45 cm is equal to 145 cm

## Getting data back from functions

Functions are most useful when they send some data back to the program—a return value. To make a function return a value, add “return” followed by the value to be sent back.



### 1 Define a function that returns a number

Python’s “input()” function always returns a string, even if a number is entered. The new function below gives back a number instead.

```
def num_input(prompt):
    typed = input(prompt)
    num = int(typed)
    return num
```

The number is stored as a string in the variable “typed”

Returns the value stored in the variable

This converts the string into a number and stores it in the variable “num”

```
a = num_input('Enter a')
b = num_input('Enter b')
print('a + b =', a + b)
```

### 2 Number as output

If the program used the function “input”, “a + b” would put the strings “10” and “7” together to give “107”.

```
Enter a 10
Enter b 7
a + b = 17
```

Adding “a + b” outputs “17” because the function “num\_input” gives back numbers, not strings

## PROJECT 5

# Silly sentences

Loops, functions, and lists can be used individually for lots of different tasks. They can also be used together to create interesting programs that can do even more complex tasks.

### SEE ALSO

◀ 124–125 While loops

◀ 128–129 Lists

◀ 130–131 Functions

## Make silly sentences

This program will make sentences by using three separate lists of words. It will pick one word from each list and put them together randomly in a silly sentence.

Try using different words from the ones shown here to create your own silly sentences.



- 1** Enter the three lists shown below into a new code window. This defines the lists that will be used to make the sentences.

Single quotes show that each item in the list is a string

```
name = ['Neha', 'Lee', 'Sam']
verb = ['buys', 'rides', 'kicks']
noun = ['lion', 'bicycle', 'plane']
```

Square brackets mean that this is a list

- 2** Each sentence is made up of words picked at random from the lists you have created. Define a function to do this, because it will be used several times in the program.

This loads the function for generating a random number ("randint")

```
from random import randint
def pick(words):
    num_words = len(words)
    num_picked = randint(0, num_words - 1)
    word_picked = words[num_picked]
    return word_picked
```

Finds out how many words are in the list (the function works for lists of any length)

Picks a random number that refers to one of the items in the list

Stores the random word that has been picked in the variable "word\_picked"

- 3** Print a random silly sentence by running the “pick” function once for each of the three lists. Use the “print” command to show the sentence on the screen.

Add an “a” so that the sentence makes sense (see below)

```
print(pick(name), pick(verb), 'a', pick(noun), end='. \n')
```

- 4** Save and run the program to get a silly sentence made from the lists of names, verbs, and nouns.

Neha kicks a bicycle.

The sentence is randomly selected each time the program is run

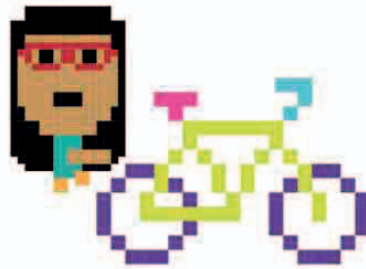

This adds a period at the end, while the “\n” starts a new line

## Silly sentences forever!

A forever loop can be added to the silly sentences program to keep it running forever, or until the user presses “Ctrl-C” to escape the loop.



### EXPERT TIPS

#### Readable code

It’s very important to write a program that can be easily understood. It makes the program easier to change in the future because you don’t have to start by solving the puzzle of how it works!

- 1** The program keeps printing silly sentences if the “print” command is wrapped in a “while True” loop.

```
while True:
    print(pick(name), pick(verb), 'a', pick(noun), end='.')
    input()
```

Wraps the print command in a loop

Prints a new sentence every time the “Enter” key is pressed

- 2** The “input()” function waits for the user to press the “Enter” key before printing another sentence. Without this it would print them too fast to read.

Sam rides a lion.  
Neha kicks a plane.  
Lee buys a bicycle.

The program will keep on creating random sentences



# Tuples and dictionaries

Python uses lists for keeping data in order. It also has other data types for storing information called “tuples” and “dictionaries”. Data types such as these, which hold lots of items, are called “containers”.

## SEE ALSO

◀ 110–111 Types of data

◀ 128–129 Lists



## Tuples

Tuples are a bit like lists, but the items inside them can't be changed. Once a tuple is set up it always stays the same.

Tuples are surrounded by brackets

```
>>> dragonA = ('Sam', 15, 1.70)
>>> dragonB = ('Fiona', 16, 1.68)
```

The items in a tuple are separated by commas

### ◁ What is a tuple?

A tuple contains items separated by commas and surrounded by brackets. Tuples are useful for collecting several bits of data together, such as a dragon's name, age, and height.

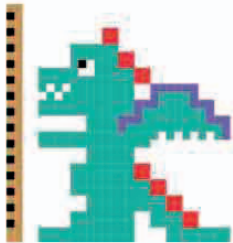

### ▷ Grabbing an item from a tuple

To get an item from a tuple, use its position in the tuple (its index). Tuples count from zero, just like lists and strings.

```
>>> dragonB[2]
1.68
```

This selects the item from position 2

```
>>> name, age, height = dragonA
>>> print(name, age, height)
Sam 15 1.7
```

The items that make up the tuple “dragonA” are displayed separately

### ◁ Splitting a tuple into variables

Assign three variables to the tuple “dragonA”—“name”, “age”, and “height”. Python splits the tuple into three items, putting one in each variable.

### ▷ Putting tuples in a list

Tuples can be put into a list because containers can go inside each other. Use this code to create a list of tuples.

```
>>> dragons = [dragonA, dragonB]
>>> print(dragons)
[('Sam', 15, 1.7), ('Fiona', 16, 1.68)]
```

Create a list of tuples called “dragons”

Lists go in square brackets

Each tuple is surrounded by round brackets inside the list's square brackets

Python displays all the items that are in the list, not just the names of the tuples



## Dictionaries

Dictionaries are like lists but they have labels. These labels, called “keys”, identify items instead of index numbers. Every item in a dictionary has a key and a value. Items in a dictionary don’t have to stay in a particular order, and the contents of a dictionary can be changed.

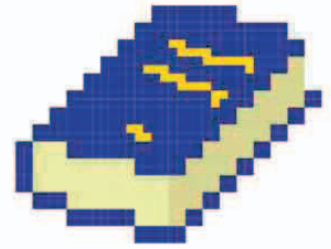

### ▷ Create a dictionary

This program creates a dictionary called “age”. The key for each item is the name of a person. The value is their age.

Dictionaries use curly brackets

Items in a dictionary are separated by commas

Use a colon between a key and a value

```
>>> age = {'Mary': 10, 'Sanjay': 8}
```

A key works in the same way as an index number

A value stored in the dictionary (always comes after a colon)

### ◁ Print the dictionary

The order of the items can change, because the positions of items in a dictionary are not fixed.

```
>>> print(age)
```

Name of the dictionary

```
{'Sanjay': 8, 'Mary': 10}
```

The key for this item is 'Sanjay'

The value of 'Mary' is 10

### ▷ Add a new item

A new value can be added to the dictionary by labeling it with the new key.

Dictionary name

New key

```
>>> age['Owen'] = 11
```

Adds a new item to the dictionary

```
>>> print(age)
```

```
{'Owen': 11, 'Sanjay': 8, 'Mary': 10}
```

The new value is now in the dictionary

The existing values are still there

### ◁ Change a value

Assign a new value to an existing key to change its value.

```
>>> age['Owen'] = 12
```

Assign a new value to the item labeled 'Owen'

```
>>> print(age)
```

```
{'Owen': 12, 'Sanjay': 8, 'Mary': 10}
```

The value for 'Owen' has changed

### ▷ Delete an item

Deleting an item in a dictionary doesn't affect other items because they are identified by their key, not by their position in the dictionary.

This deletes the item labeled 'Owen'

```
>>> del age['Owen']
```

```
>>> print(age)
```

```
{'Sanjay': 8, 'Mary': 10}
```

The item labeled 'Owen' no longer appears in the dictionary

# Lists in variables

There's something about how Python stores lists in variables that might seem a bit odd at first. But take a look at what's going on behind the scenes and it all makes sense.

## SEE ALSO

◀ **108–109** Variables in Python

◀ **128–129** Lists

## Remember how variables only store values?

Variables are like boxes that hold values. The value in one variable can be copied and stored in another. It's like photocopying the value contained in box "a" and storing a copy in box "b".

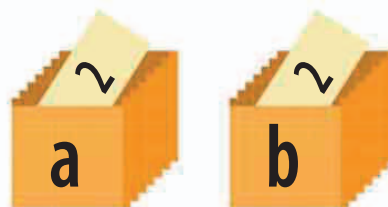

### △ How variables work

Each variable is like a box containing a piece of paper with a value written on it.

### 1 Assign a value to a variable

Assign the value 2 to variable "a", then assign the value in "a" to variable "b". The value 2 is copied and stored in "b".

```
>>> a = 2
>>> b = a
>>> print('a =', a, 'b =', b)
a = 2 b = 2
```

This copies the contents of "a" into "b"

Now "a" and "b" both contain the value 2

This prints out the variable names with their values

### 2 Change a value

If you change the value stored in one variable it won't affect the value stored in another variable. In the same way, changing what's written on a piece of paper in box "a" won't affect what's on the paper in box "b".

```
>>> a = 100
>>> print('a =', a, 'b =', b)
a = 100 b = 2
```

Change the value in "a" to 100

Now "a" contains 100, but "b" still contains 2

### 3 Change a different value

Change the value in "b" to 22. Variable "a" still contains 100. Even though the value of "b" was copied from "a" at the start, they are now independent—changing "b" doesn't change "a".

```
>>> b = 22
>>> print('a =', a, 'b =', b)
a = 100 b = 22
```

"b" now contains 22, but "a" is still 100

## What happens if a list is put in a variable?

Copying the value in a variable creates two independent copies of the value. This works if the value is a number, but what about other types of value? If a variable contains a list it works a bit differently.

**1 Copy a list**  
Store the list [1, 2, 3] in a variable called "listA". Then store the value of "listA" in another variable called "listB". Now both variables contain [1, 2, 3].

```
>>> listA = [1, 2, 3]
>>> listB = listA
>>> print('listA =', listA, 'listB =', listB)
listA = [1, 2, 3] listB = [1, 2, 3]
```

Use square brackets to create a list

This prints out the variable names alongside their values to see what's inside them

"listA" and "listB" both hold the same value

This changes the second item in the list because lists count from zero

**2 Change list A**  
Change the value in "listA[1]" to 1,000. "listB[1]" now contains 1,000 as well. Changing the original list has changed the copy of the list too.

```
>>> listA[1] = 1000
>>> print('listA =', listA, 'listB =', listB)
listA = [1, 1000, 3] listB = [1, 1000, 3]
```

This is the third item in the list

The second item of both "listA" and "listB" has been changed

**3 Change list B**  
Change the value of "listB[2]" to 75. "listA[2]" is now 75 as well. Changing the copy of the list has changed the original list as well.

```
>>> listB[2] = 75
>>> print('listA =', listA, 'listB =', listB)
listA = [1, 1000, 75] listB = [1, 1000, 75]
```

The third item of both "listA" and "listB" has been changed

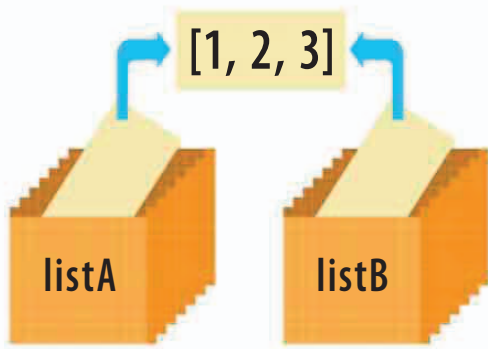

### △ What's going on?

A variable containing a list doesn't hold the list itself, just a link to it. Copying the value in "listA" copies the link. So both "listA" and "listB" contain a link to the same list.

### EXPERT TIPS

#### Copying lists

To make a separate copy of a list, use the "copy" function. "listC" will contain a link to a completely new list whose values are copies of those in "listA". Changing "listC" won't change "listA", and changing "listA" won't change "listC".

```
>>> listC = listA.copy()
```

# Variables and functions

Variables created inside a function (local variables) and variables created in the main program (global variables) work in different ways.

## Local variables

Local variables only exist inside a single function, so the main program and other functions can't use them. If you try to use a local variable outside of the function, an error message appears.

Local variables are like film stars in a car with mirrored windows—they are inside the car (function) but no one can see them

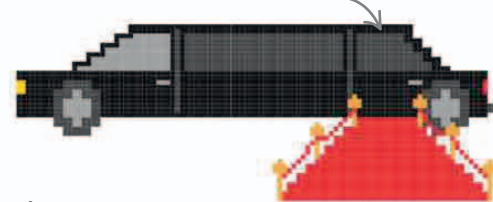

**1 Variable inside the function**  
Create a local variable called "a" inside "func1". Print out the value of "a" by calling "func1" from the main program.

```
>>> def func1():
    a = 10
    print(a)
>>> func1()  Calling "func1"
10           prints the value
             given to "a"
```

**2 Variable outside the function**  
If you try to print "a" directly from the main program, it gives an error. "a" only exists inside "func1".

```
>>> print(a)
Traceback (most recent call last):
  File "<pyshell#6>", line 1, in <module>
    print(a)
NameError: name 'a' is not defined
```

The main program doesn't know what "a" is, so it prints an error message

## Global variables

A variable created in the main program is called a global variable. Other functions can read it, but they can't change its value.

**1 Variable outside the function**  
Create a global variable called "b" in the main program. The new function ("func2") can read the value of "b" and print it.

```
>>> b = 1000
>>> def func2():
    print(b)
>>> func2()
1000
```

"func2" can see the value of "b" because "b" is a global variable

Printing "func2" gives you the value stored in "b"

**2 Same global variable**  
We can also print "b" directly from the main program. "b" can be seen everywhere because it wasn't created inside a function.

```
>>> print(b)
1000
```

Global variable "b" can be used anywhere in the main program

Global variables are like people walking along the street—everyone can see them



### SEE ALSO

◀ 130–131 Functions

Making 158–159 shapes

## Variables as input to functions

When a variable is used as input to a function its value is copied into a new local variable. Therefore, changing the value of this new local variable inside the function doesn't change the value of the original variable.

**1 Changing values inside a variable**  
"func3" uses input "y", which is a local variable. It prints the value of "y", then changes that value to "bread" and prints the new value.

```
>>> def func3(y):
    print(y)
    y = 'bread'
    print(y)
>>> z = 'butter'
>>> func3(z)
butter
bread
```

Annotations for the first code block:

- Arrow from `func3(y)` to `y`: "y" contains the value passed to it when "func3" is called
- Arrow from `print(y)` to `y`: Here "y" contains "bread"
- Arrow from `func3(z)` to `z`: This creates a global variable called "z"
- Arrow from `func3(z)` to `func3`: The input "y" now contains the value of "z" passed to it when "func3" is called

**2 Print variable**  
Printing the value of "z" after calling "func3" shows it hasn't changed. Calling "func3" copies the value in "z" ("butter") into local variable "y", but "z" is left unchanged.

```
>>> print(z)
butter
```

Annotations for the second code block:

- Arrow from `print(z)` to `z`: Prints the value in global variable "z" after "func3" has finished running
- Arrow from `print(z)` to `func3`: Local variable "y" of "func3" holds a copy of the value in "z". Although "y" has been changed to "bread", the value in global variable "z" isn't affected and is still "butter"

## Masking a global variable

A global variable can't be changed by a function. A function trying to change a global variable actually creates a local variable with the same name. It covers up, or "masks", the global variable with a local version.

**1 Changing a global variable**  
Global variable "c" is given the value 12345. "func4" gives "c" the value 555 and prints it out. It looks like our global variable "c" has been changed.

```
>>> c = 12345
>>> def func4():
    c = 555
    print(c)
>>> func4()
555
```

Annotations for the third code block:

- Arrow from `c = 12345` to `c`: Initial value in global variable "c"
- Arrow from `func4()` to `func4`: Prints the value of "c" inside "func4"

**2 Print variable**  
If we print "c" from outside the function, we see that "c" hasn't changed at all. "func4" only prints the value of its new local variable—also called "c".

```
>>> print(c)
12345
```

Annotation for the fourth code block:

- Arrow from `print(c)` to `c`: The value in global variable "c" hasn't been changed



### EXPERT TIPS

## Calling functions

There are two different ways of calling functions.

### function(a)

In Python, items of data are called "objects". Some functions are called by passing them the data object ("a").

### a.function()

Other functions are called by adding their name at the end of the data object ("a") after a period.

## PROJECT 6

# Drawing machine

It's time to try a more complex project. This program, the drawing machine, turns a string of simple instructions into turtle commands to draw different shapes. The skills used in planning this program are essential for any coder.

### SEE ALSO

◀ 122–123 Loops in Python

Libraries 152–153 ▶

## Choose a test shape

To write a program that can draw any shape, it's useful to choose a shape to start with. Use this house shape as an example to test the program at each stage. By the end of the project it will be possible to draw this house with far less code—by using a single string containing several short drawing commands (for example, "F100").

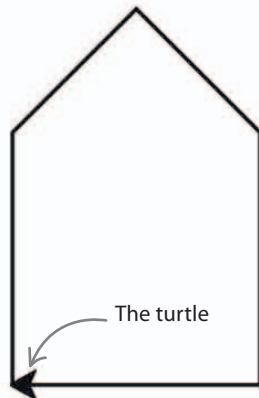

### ▷ Turtle draws a house

The arrow shows the final direction and position of the turtle. Starting at the bottom left, it has moved clockwise around the house.

```
from turtle import *
reset() ← Loads all the commands that control the turtle
left(90)
forward(100) ← Resets the turtle's position and puts the pen down ready to draw
right(45)
forward(70)
right(90) ← Moves the turtle forward by 70
forward(70)
right(45)
forward(100) ← Makes the turtle turn 90 degrees to the right
right(90) ←
forward(100)
```

### △ Program to draw a house

This code tells the turtle to draw a house. It requires lots of lines of code for what is actually quite a simple program.

## Three parts of the program

The drawing machine will be a large program. To help with the planning, it can be broken down into three parts, each one related to a different task.

### Function 1

#### △ Turtle controller

This function takes a simple command from the user and turns it into a turtle command. The user command will come as a single letter and a number.

### Function 2

#### △ String artist

In this program, the user enters a string of instructions. This function splits the string into smaller units, which are then fed to the Turtle controller.

### Main program

#### △ User interface

The String artist needs to get its input from somewhere. The User interface allows the user to type in a string of commands for the String artist to work on.

## Draw a flowchart

Coders often plan programs on paper, to help them write better code with fewer errors. One way to plan is to draw a flowchart—a diagram of the steps and decisions that the program needs to follow.

**1** This flowchart shows the plan for the Turtle controller function. It takes a letter (input “do”) and number (input “val”) and turns them into a turtle command. For example, “F” and “100” will be turned into the command “forward(100)”. If the function doesn’t recognize the letter, it reports an error to the user.



Each command has two variables: “do” (a string) tells the turtle what to do, and “val” (an integer, or whole number) tells the turtle how much or how far to do it

The function has to decide if the “do” value is a letter it recognizes

If “do” isn’t F, the function runs through other letters it recognizes

“do” isn’t “R”.  
Is it “U”?



### EXPERT TIPS

## Squares and diamonds

Flowcharts are made up of squares and diamonds. The squares contain actions that the program performs. The diamonds are points where it makes a decision.



Action



Decision

## Letter commands

The Turtle controller will use these letters to stand for different turtle commands:

- N** = New drawing (reset)
- U/D** = Pen up/down
- F** = Forward
- B** = Backwards
- R** = Right turn
- L** = Left turn

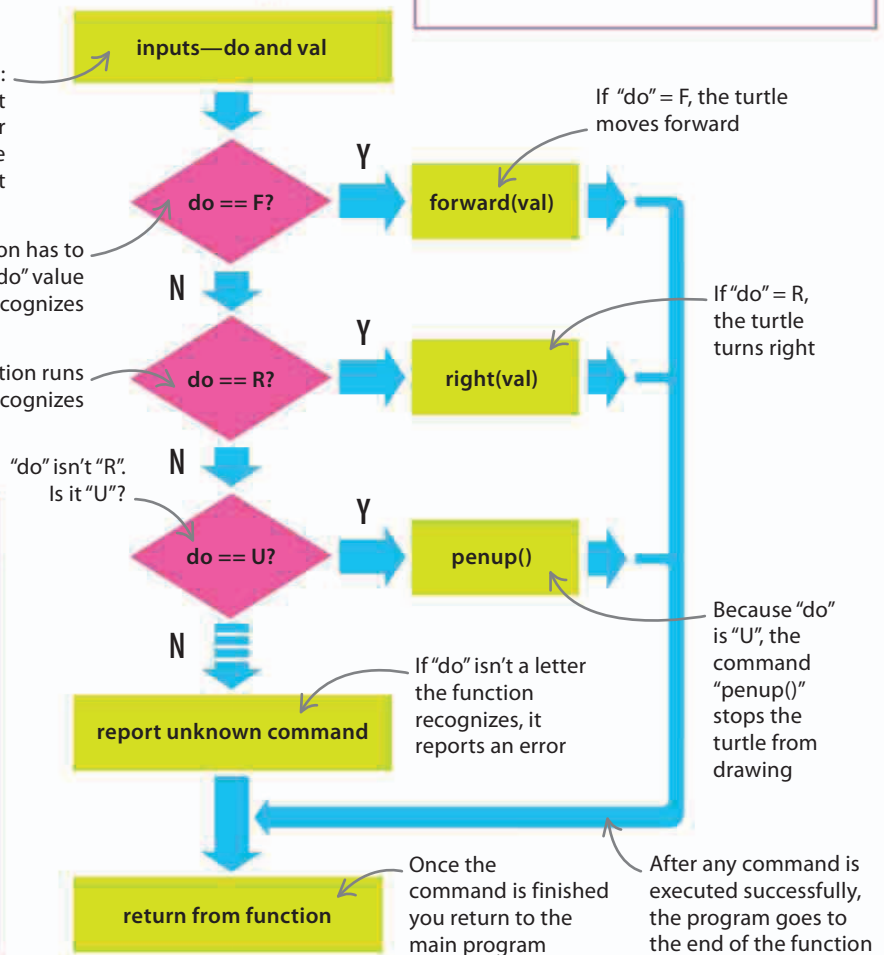

## DRAWING MACHINE

### The Turtle controller

The first part of the program is a function that moves the turtle, one command at a time. It is planned out in the flowchart on the previous page. This code enables the turtle to convert the “do” and “val” values into movement commands.

**2** This code creates the Turtle controller function. It turns “do” inputs into directions for the turtle, and “val” inputs into angles and distances.



This command tells the turtle to start drawing on the page

The starting position of the turtle

```
from turtle import *
def turtle_controller(do, val):
    do = do.upper()
    if do == 'F':
        forward(val)
    elif do == 'B':
        backward(val)
    elif do == 'R':
        right(val)
    elif do == 'L':
        left(val)
    elif do == 'U':
        penup()
    elif do == 'D':
        pendown()
    elif do == 'N':
        reset()
    else:
        print('Unrecognized command')
```

Loads all the commands that control the turtle

Defines “do” and “val” as inputs for the function

This command converts all the letters in “do” to upper case (capital letters)

This tells the function to turn a “do” value of F into the turtle command “forward”

As in the flowchart, the function checks the “do” letter against all the letters it understands

This command instructs the turtle to stop drawing on the page

This command resets the turtle’s position to the center of the screen

This message appears if the “do” value is a letter that the function cannot recognize

**3** Here are some examples of how to use the Turtle controller. Each time it is used, it takes a “do, val” command and turns it into code the turtle can understand.

```
>>> turtle_controller('F', 100)
>>> turtle_controller('R', 90)
>>> turtle_controller('F', 50)
```

This calls the function using its name

These “do” and “val” inputs tell the turtle to move 100 steps forward

This makes the turtle turn right 90 degrees



## Write some pseudocode

Another way to plan a program is to write it in pseudocode. “Pseudo” means fake, so pseudocode isn’t real code that you can run. It’s rough code where you can write your ideas in the style of the real thing.

**4** It’s time to plan the String artist. This function takes a string of several “do” and “val” inputs and breaks it into pairs made up of a letter and a number. It then passes the pairs to the Turtle controller one at a time.

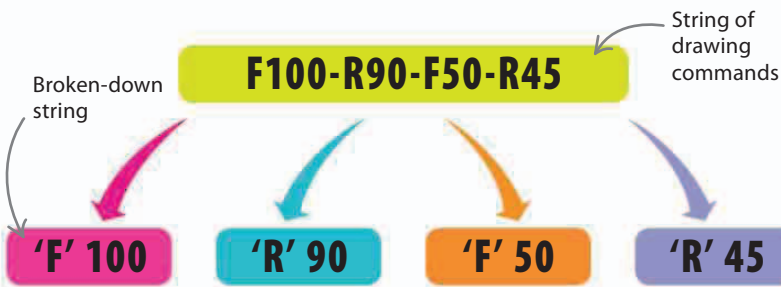

**5** This is the String artist written in pseudocode. It lets you organize the ideas and structure of the code without having to think about the details yet.

```
function string_artist(input—the program as a string):
    split program string into list of commands
    for each command in list:
        check it's not blank
            —if it is go on to next item in list
        command type is the first letter
        if followed by more characters
            —turn them into a number
        call turtle_controller(command type, number)
```

The function will take in a string of commands input by the user (for example, "F100-R90")

Splits string into a list of separate commands

A blank command won't work, so the function skips it

Recognizes the first letter as a "do" command

Recognizes the following characters as a "val" number

Passes the simple command to Turtle controller



### EXPERT TIPS

#### Clear coding

It's not only computers that need to be able to read your code, it should be clear to people too. So it's important to make your code as easy to understand as possible.

**Use functions** to break your code into smaller chunks. Each function should do a single task in the program.

**Give your variables** and functions names that say what they do: "age\_in\_years" makes more sense than "aiy".

**Use plenty of comments** (using the "#" symbol) to explain what's happening. This makes it easier to read back over the code.

**Don't use symbols** that can be confused with others: an upper-case "O" looks like zero, and a lower-case "L" can look like an upper-case "i" or a "1".



## DRAWING MACHINE

### Creating the String artist

The pseudocode on the previous page plans a function called the String artist, which will turn a string of values into single commands that are sent to the Turtle controller. The next stage is to turn the pseudocode into real Python code, using a function called “split()”.

**6** The “split()” function splits a string into a list of smaller strings. Each break point is marked by a special character (“-” in this program).

This string lists the commands to create the sample house shape

```
>>> program = 'N-L90-F100-R45-F70-R90-F70-R45-F100-R90-F100'
>>> cmd_list = program.split('-')
>>> cmd_list
['N', 'L90', 'F100', 'R45', 'F70', 'R90', 'F70', 'R45', 'F100', 'R90', 'F100']
```

The “split()” function breaks the string down into a list of separate commands

**7** Now write out the pseudocode for the String artist using real Python code. Use the “split()” function to slice up the input string into turtle commands.

Tells the program to split the string wherever it sees a “-” character

This makes the program loop through the list of strings—each item is one command for the turtle

If the length of the command is 0 (so the command is blank), the function skips it and moves to the next one

Takes the first character of the command (remember, strings start at 0) and sets it as the command type (“F”, “U”, etc.)

This takes all the remaining characters from the command by cutting off the first one

Prints the command on the screen so you can see what the code is doing

Passes the command to the turtle

```
def string_artist(program):
    cmd_list = program.split('-')
    for command in cmd_list:
        cmd_len = len(command)
        if cmd_len == 0:
            continue
        cmd_type = command[0]
        num = 0
        if cmd_len > 1:
            num_string = command[1:]
            num = int(num_string)
        print(command, ':', cmd_type, num)
        turtle_controller(cmd_type, num)
```

Gets the length of the command string

Converts the characters from strings into numbers

Checks if the command is followed by more characters (the number)

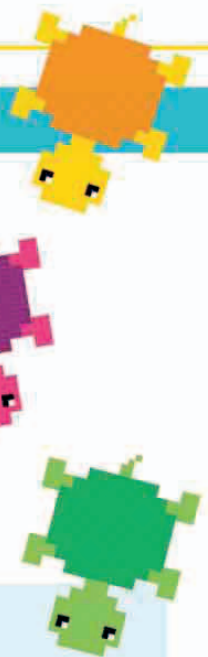

**8** When the string representing the instructions for the house shape is passed into the String artist, it shows this output in the shell window.

```
>>> string_artist('N-L90-F100-R45-F70-R90-F70-R45-F100-R90-F100')
```

**N : N 0** ← Resets the screen and puts the turtle back at the center

**L90 : L 90** ← The turtle turns 90 degrees left, ready to draw the left side of the house

**F100 : F 100** ← For command "F100", the command type is "F" and "num" is "100"

**R45 : R 45** ← This makes the turtle turn 45 degrees before drawing the roof

**F70 : F 70** ← This makes the turtle turn 45 degrees before drawing the roof

**R90 : R 90** ← This command makes the turtle draw the right-hand side of the roof

**F70 : F 70** ← This command makes the turtle draw the right-hand side of the roof

**R45 : R 45** ← This command makes the turtle draw the right-hand side of the roof

**F100 : F 100** ← The turtle turns 90 degrees right, ready to draw the bottom of the house

**R90 : R 90** ← The turtle turns 90 degrees right, ready to draw the bottom of the house

**F100 : F 100** ← The turtle turns 90 degrees right, ready to draw the bottom of the house

The turtle commands are all separated by a "-"



**9** Each command in the string that is passed to the "string\_artist" function is extracted, identified, and executed. A picture of a house is drawn in the turtle graphics window.

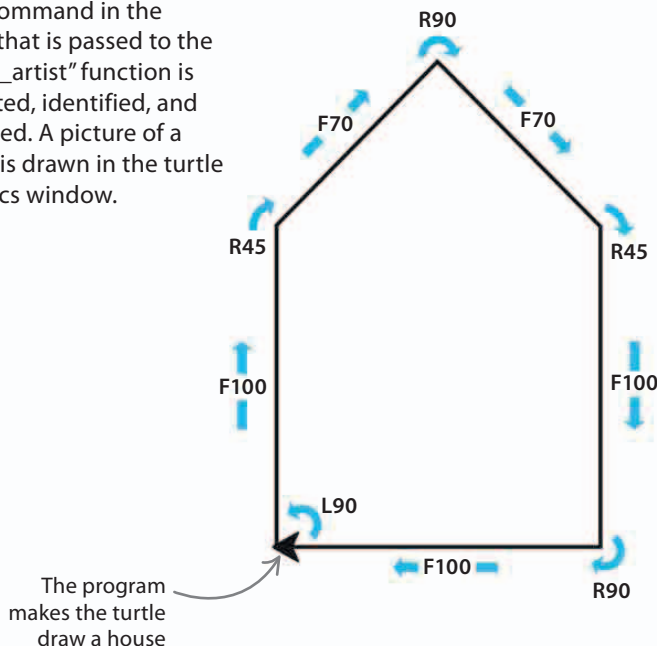

## REMEMBER Commands

Here's a reminder of the turtle commands in this program. Some of these are only one letter long, while others include a number telling the turtle how far to travel or turn. Each time you activate "string\_artist", it adds to the drawing, until "N" clears the screen.

- N** = New drawing
- U/D** = Pen Up/Down
- F100** = Forward 100
- B50** = Backwards 50
- R90** = Right turn 90 deg
- L45** = Left turn 45 deg



## DRAWING MACHINE

### Finish off the code with a user interface

The drawing machine needs an interface to make it easier to use. This will let the user enter a string from the keyboard to tell the machine what to draw.



**10** This code creates a pop-up window where the user can input instructions. A "while True" loop lets them keep entering new strings.

The triple quote (""") tells Python that everything until the next triple quote is part of the same string, including the line breaks

```
instructions = '''Enter a program for the turtle:
```

```
eg F100-R45-U-F100-L45-D-F100-R90-B50
```

```
N = New drawing
```

```
U/D = Pen Up/Down
```

```
F100 = Forward 100
```

```
B50 = Backwards 50
```

```
R90 = Right turn 90 deg
```

```
L45 = Left turn 45 deg'''
```

```
screen = getscreen()
```

```
while True:
```

```
    t_program = screen.textinput('Drawing Machine', instructions)
```

```
    print(t_program)
```

```
    if t_program == None or t_program.upper() == 'END':
```

```
        break
```

```
    string_artist(t_program)
```

Tells the user what letters to use for different turtle commands

End of the string

Gets the data needed to create the pop-up window

This line tells the program what to show in the pop-up window

Stops the program if the user types "END" or presses the "Cancel" button

Passes the string to the String artist function

**11** This window pops up over the turtle window ready for the user to type a drawing machine program string.

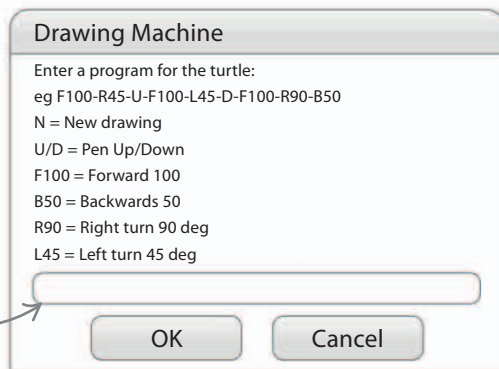

Type the program string here and then click "OK" to run the program



#### △ Turtle control

Using this program, the turtle is easier to control, and you don't have to restart the program to draw another picture.

**12** The drawing machine can be used to create more than just outlines. By lifting up the turtle's pen while moving to a new position, it's possible to fill in details inside a shape. Run the program and try entering the string below.

```
N-L90-F100-R45-F70-R90-F70-R45-F100-R90-F100-
B10-U-R90-F10-D-F30-R90-F30-R90-F30-R90-F30
```

Lifts up the turtle's pen so it moves without leaving a line

Puts the pen down to draw a window

The house now has a window

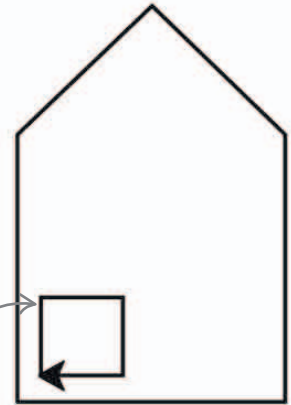

## Time for something different

Now you know how to add details, you can really have fun with the drawing machine. Try drawing this owl face using the string of instructions below.

```
N-F100-L90-F200-L90-F50-R60-F30-L120-F30-R60-F40-
R60-F30-L120-F30-R60-F50-L90-F200-L90-F100-L90-U-
F150-L90-F20-D-F30-L90-F30-L90-F30-L90-F30-R90-U-
F40-D-F30-R90-F30-R90-F30-R90-F30-L180-U-F60-R90-
D-F40-L120-F40-L120-F40
```

The string lifts the pen three times to draw the eyes and beak separately

The arrow shows where the turtle stopped. This means that the owl's beak was drawn last

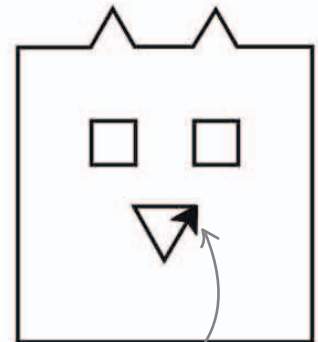

## REMEMBER

### Achievements

You created the drawing machine program by achieving several smaller targets:

**Used a flowchart** to plan a function by working out the decision points and the resulting actions.

**Wrote pseudocode** to plan out a function before writing out the real code.

**Created the function** "turtle\_controller" that works out what turtle command to execute from the letter and number it's been given.

**Created the function** "string\_artist" that produced a turtle drawing from a string of instructions.

**Made an interface** that allows the user to tell the program what to draw from the keyboard.

# Bugs and debugging

Programmers aren't perfect, and most programs contain errors at first. These errors are known as "bugs" and tracking them down is called "debugging".

## SEE ALSO

◀ 94–95 Errors

◀ 122–123 Loops  
in Python

What next? 176–177 ▶

## Types of bugs

Three main types of bugs can turn up in programs—syntax, runtime, and logic errors. Some are quite easy to spot, while others are more difficult, but there are ways of finding and fixing them all.

The Python keyword is "for" not "fir"

```
fir i in range(5):
    print(i)
```

### △ Easy to spot

A syntax error is a mistake in the program's words or symbols, such as misspelled keywords, missing brackets, or incorrect indents.

This will cause an error as no number can be divided by 0

```
a = 0
print(10 / a)
```

### △ Harder to spot

Runtime errors appear only when the program is running. Adding numbers to strings or dividing by 0 can cause them.

Age cannot be less than 5 and greater than 8 at the same time, so no free tickets

```
if age < 5 and age > 8:
    print('Free ticket!')
```

### △ Hardest to spot

Logic errors are mistakes in a program's thinking. Using "<" instead of ">", for example, or adding when you should be subtracting result in these errors.

## Find and fix a bug

Syntax errors are easy to spot because IDLE highlights them in red when you run the program. Finding runtime and logic errors takes a bit more work.

### 1 Problem program

This program aims to add all the numbers from 1 up to the value stored in the variable "top\_num". It then prints the total.

```
top_num = 5
total = 0
for n in range(top_num):
    total = total + n
print('Sum of numbers 1 to', top_num, 'is', total)
```

The highest number in the series of numbers being added

This command prints a sentence to let the user know the result

### 2 Output

The answer for the program should be (1 + 2 + 3 + 4 + 5), but it shows the answer as "10". You need to find out why.

Sum of numbers 1 to 5 is 10

The answer should be "15", not "10"



### 3 Add a “print” and “input()”

The program doesn't show what it's doing at each step. Adding a “print” command here will let you see what's happening. The “input()” command waits for the “return” or “Enter” key to be pressed before looping.

```
top_num = 5
total = 0
for n in range(top_num):
    total = total + n
    print('DEBUG: n=', n, 'total=', total)
    input()
print('Sum of numbers 1 to', top_num, 'is', total)
```

This command prints the current value of the loop variable and the total so far



### 4 New output

The loop is only adding the numbers from 0 up to 4, and not 1 to 5. This is because a “for” loop always starts counting from 0 (unless told otherwise), and always stops 1 before the end of the range.

```
DEBUG: n= 0 total= 0
DEBUG: n= 1 total= 1
DEBUG: n= 2 total= 3
DEBUG: n= 3 total= 6
DEBUG: n= 4 total= 10
Sum of numbers 1 to 5 is 10
```

This is actually the sum of the numbers from 0 to 4, not 1 to 5



### 5 Fix the faulty line

The range should go from 1 up to “top\_num + 1”, so that the loop adds up the numbers from 1 to “top\_num” (5).

```
top_num = 5
total = 0
for n in range(1, top_num + 1):
    total = total + n
    print('DEBUG: n=', n, 'total=', total)
    input()
print('Sum of numbers 1 to', top_num, 'is', total)
```

The new range will count from 1 and stop at “top\_num” (1 less than “top\_num + 1”)



### 6 Correct output

The “print” command shows that the program is adding the numbers from 1 to 5 and getting the correct answer. The bug has now been fixed!

```
DEBUG: n= 1 total= 1
DEBUG: n= 2 total= 3
DEBUG: n= 3 total= 6
DEBUG: n= 4 total= 10
DEBUG: n= 5 total= 15
Sum of numbers 1 to 5 is 15
```

When “n= 3”, the total is (1 + 2 + 3)

The correct answer is now printed



# Algorithms

An algorithm is a set of instructions for performing a task. Some algorithms are more efficient than others and take less time or effort. Different types of algorithms can be used for simple tasks such as sorting a list of numbers.

## Insertion sort

Imagine you've been given your class's exam papers to put in order from the lowest to the highest mark. "Insertion sort" creates a sorted section at the top of the pile and then inserts each unsorted paper into the correct position.

### ▽ How it works

"Insertion sort" goes through each of these stages sorting the numbers far quicker than a human could.

**6 is sorted into position 1**

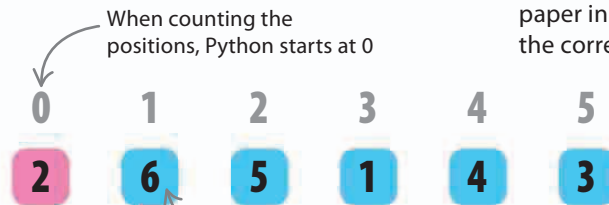

**5 is sorted into position 1**



**1 is sorted into position 0**

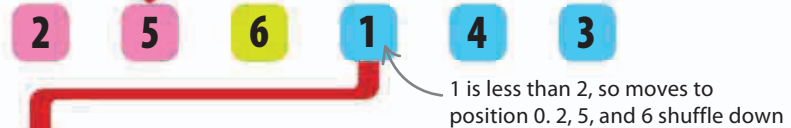

**4 is sorted into position 2**



**3 is sorted into position 2**



**Sorted!**

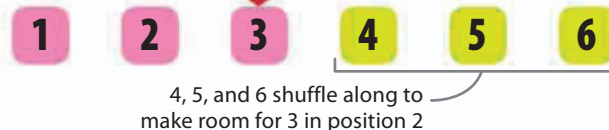

### SEE ALSO

◀ 16–17 Think like a computer

Libraries 152–153 ▶



### △ Sorting in order

"Insertion sort" takes each paper in turn and inserts it into the correct (sorted) place.



# Selection sort

“Selection sort” works differently to “insertion sort”. It swaps pairs of items rather than constantly shifting all of the items. Each swap moves one number to its final (sorted) position.

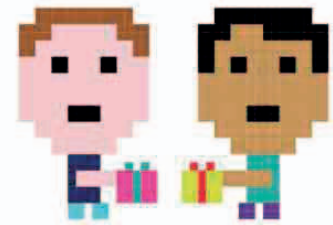

### △ Swapping positions

Switching one thing with another is usually quick and doesn't affect anything else in the list.

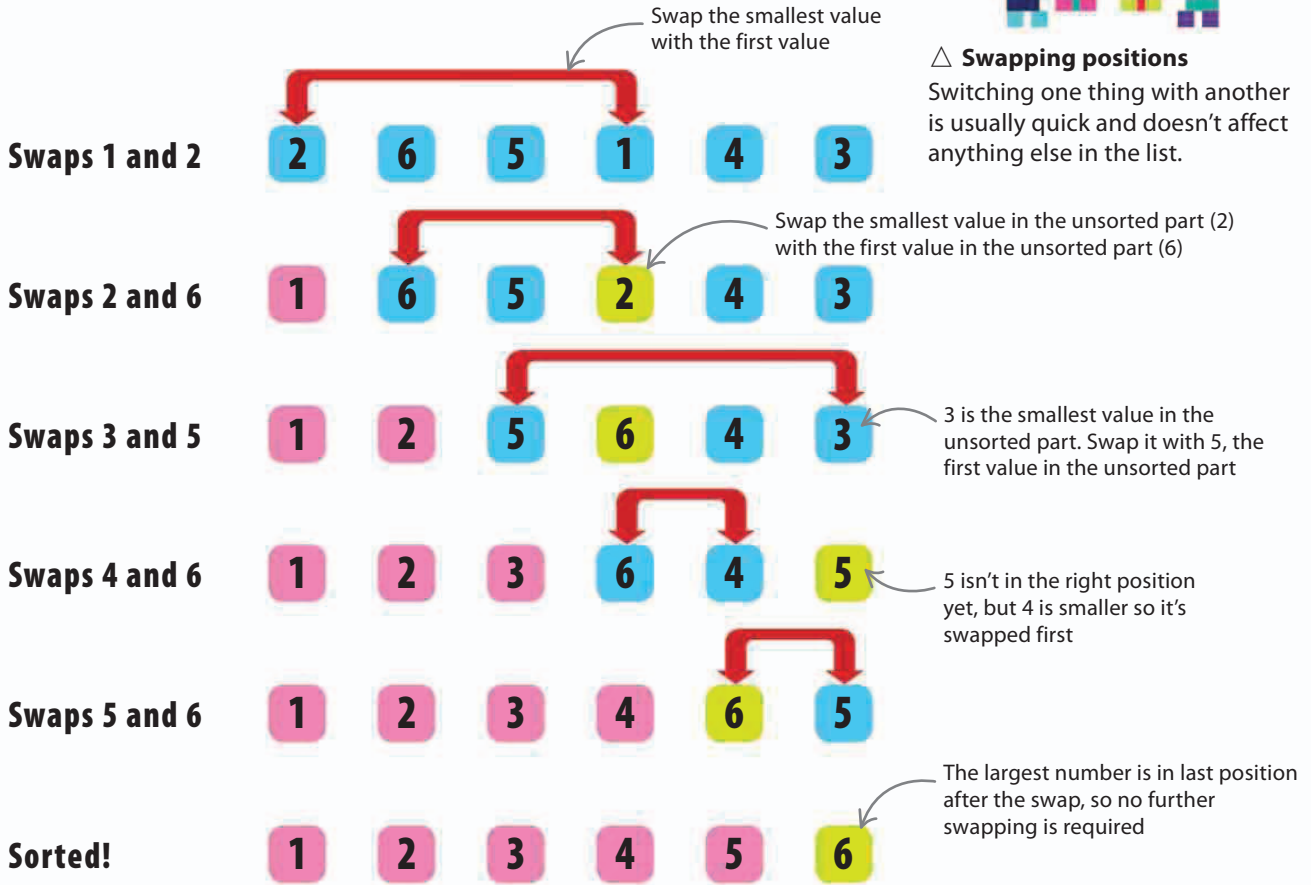

## EXPERT TIPS

### Sorting in Python

There are lots of different sorting algorithms, each with different strengths and weaknesses. Python's "sort()" function uses an algorithm called "Timsort", named after its designer, Tim Peters. It's based on two sorting algorithms: "Insertion sort" and "Merge sort". Type in this code to see how it works.

```
>>> a = [4, 9, 3, 8, 2, 6, 1, 5, 7]
>>> a.sort()
>>> a
[1, 2, 3, 4, 5, 6, 7, 8, 9]
```

"a" is a list of unsorted numbers

This calls the "sort()" function

The numbers in list "a" are now sorted

# Libraries

Writing new code takes time, so it's useful to be able to reuse bits of other programs. These snippets of code can be shared in packages called "libraries".

## SEE ALSO

Making **154–155** ›  
windows

Color and **156–157** ›  
coordinates

## Standard Library modules

Python comes with a "Standard Library" that has lots of useful bits of code ready to use. Stand-alone sections of a library called "modules" can be added to Python to make it even more powerful.

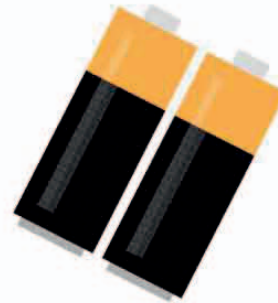

### ◁ Batteries included

Python's motto is "batteries are included". This means it comes with lots of ready-to-use code.



### ◁ Random

This module can pick a random number, or shuffle a list into a random order.



### ▽ Turtle

This module is used to draw lines and shapes on the screen.

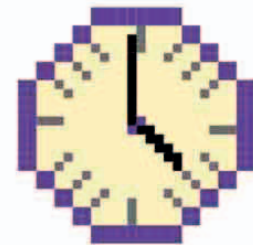
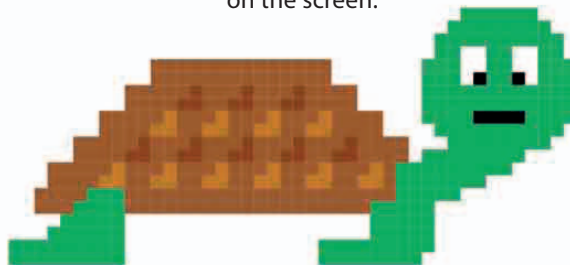

### △ Time

The Time module gives the current time and date, and can calculate dates—for instance, what day will it be in three days' time?



### △ Socket

The code in this module helps computers connect to each other over networks and the Internet.

### ▽ Tkinter

Tkinter is used to make buttons, windows, and other graphics that help users interact with programs.

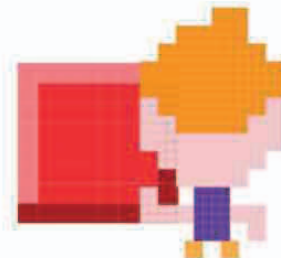

### ▷ Math

Use the Math module to work with complex mathematical calculations.

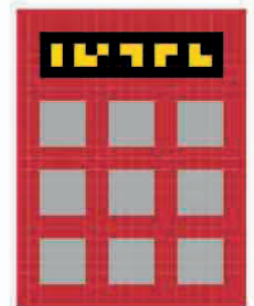

## Importing modules

Before using a module, you have to tell the computer to import it so it can be used by your program. This allows the bits of code it contains to be available to you. Importing modules is done using the “import” command. Python can import modules in a few different ways.

```
import random
```

```
random.randint(1, 6)
random.choice(my_list)
```

The module name comes before each function

### ▷ “from random import \*”

Importing a module like this works well for small programs. But it can get confusing with bigger programs because it isn’t clear which module the function belongs to.

```
from random import *
```

Imports all the functions from the Random module

```
randint(1, 6)
choice(my_list)
```

This code doesn’t show which module the function came from

Imports only the “randint” function

```
from random import randint
```

```
randint(1, 6)
```

Only the “randint” function is available

## Help and documentation

Not sure how to use a module or what functions are available? The Python Library Reference has all the details. Simply click on the library you want to learn more about. It’s a good idea to get to know the libraries, modules, and functions that are available, so you don’t waste time writing code that already exists.



### EXPERT TIPS

## Pygame

Pygame is a Python library designed for writing video games. Pygame gives you access to sound modules and special graphics that can be used in games. You’ll be able to use Pygame once you have a good understanding of the basics of Python covered in this book.

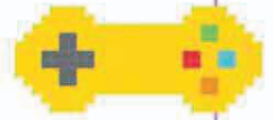

### ◁ Help!

At the top of any IDLE window, click “Help” and choose “Python Docs”. This brings up a window with lots of useful information.

Help

About IDLE

IDLE Help

Python Docs



# Making windows

Many programs have windows and buttons that can be used to control them. These make up the “graphical user interface”, or “GUI” (pronounced “gooey”).

## SEE ALSO

Color and coordinates **156–157** >

Making shapes **158–159** >

Changing things **160–161** >

## Make a simple window

The first step in creating a GUI is to make the window that will hold everything else inside it. Tkinter (from Python’s Standard Library) can be used to create a simple one.

### 1 Enter the code

This code imports Tkinter from the library and creates a new window. Tkinter must be imported before it can be used.

This imports Tkinter from the library

```
from tkinter import *
window = Tk()
```

This creates a Tkinter window

### 2 A Tkinter window appears

Run the code and a window appears. It looks a bit dull for now, but this is only the first part of your GUI.

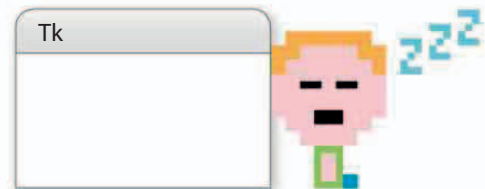

## Add buttons to the window

Make the GUI more interactive by adding buttons. A different message will be displayed when the user clicks each button.

### 1 Create two buttons

Write this code to create a simple window with two buttons.

```
from tkinter import *
def bAAction():
    print('Thank you!')
def bBAction():
    print('Ouch! That hurt!')
window = Tk()
buttonA = Button(window, text='Press me!', command=bAAction)
buttonB = Button(window, text='Don\'t press!', command=bBAction)
buttonA.pack()
buttonB.pack()
```

This message appears when button A is pressed

This message appears when button B is pressed

This label will appear on button A

This label will appear when the button is clicked

This code tells the computer to put the buttons in the window

This label will appear on button B



**2 Click the buttons to print messages**

When the program is run, a window with two buttons appears. Click the buttons and different messages will appear in the shell. You've now made an interactive GUI that responds to the user's commands.



## Roll the dice

Tkinter can be used to build a GUI for a simple application. The code below creates a program that simulates rolling a six-sided dice.



**1 Create a dice simulator**

This program creates a button that, when pressed, tells the function "roll()" to display a random number between 1 and 6.

```

from tkinter import *
from random import randint
def roll():
    text.delete(0.0, END)
    text.insert(END, str(randint(1,6)))
window = Tk()
text = Text(window, width=1, height=1)
buttonA = Button(window, text='Press to roll!', command=roll)
text.pack()
buttonA.pack()
    
```

This imports the function "randint" from the random library

This code clears the text inside the text box and replaces it with a random number between 1 and 6

Creates a text box to display the random number

This tells the program which function to run when the button is clicked

This label appears on the button

This puts the text box and the button in the window

**2 Press the button to roll the dice**

Run the program, then click the button to roll the dice and see the result. This program can be simply changed so that it simulates a 12-sided dice, or a coin being tossed.

A new number appears here each time the button is clicked

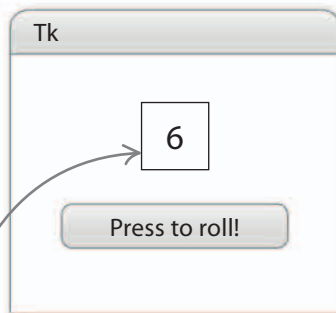

**EXPERT TIPS**

### Clear and simple

When you're designing a GUI, try not to confuse the user by filling the screen with too many buttons. Label each button with a sensible name to make the application easy to understand.

# Color and coordinates

Pictures and graphics on a computer screen are made up of tiny colored dots called pixels. To create graphics in a program, the computer needs to be told exactly what color each pixel should be.

## Selecting colors

It's important to describe colors in a way that computers can understand. Tkinter includes a useful tool to help you do this.

- 1 Launch the color selection tool**  
Type the following code into the shell window to launch the Tkinter tool for selecting colors.

```
>>> from tkinter import *
>>> t = Tk()
>>> colorchooser.askcolor()
```

This imports all of the Tkinter functions

Use the American spelling of color

- 2 Choose a color**  
The "color chooser" window will appear. Pick the color you want and then click the "OK" button.

This window makes it easy to pick the exact color you want

Select the color you want by clicking on it

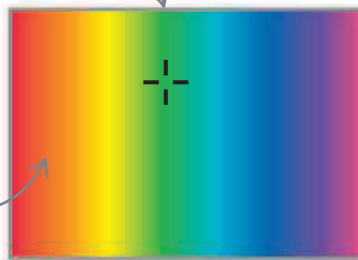

- 3 Color values**  
When a color is selected, a list of numbers will appear in the shell window. These numbers are the values of red, green, and blue that have been mixed to make the chosen color.

```
((60.234, 190.742, 52.203), '#3cbe34')
```

Red value

Green value

Blue value

Code for the color in hexadecimal (see pp.182–183)

### SEE ALSO

◀ **154–155** Making windows

Making **158–159** shapes

Changing **160–161** things



### EXPERT TIPS

## Mixing colors

Each pixel can give out red, green, and blue light. By mixing these colors together, you can make any color imaginable.

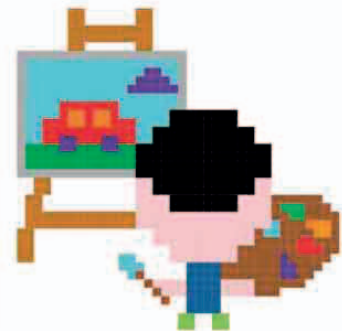
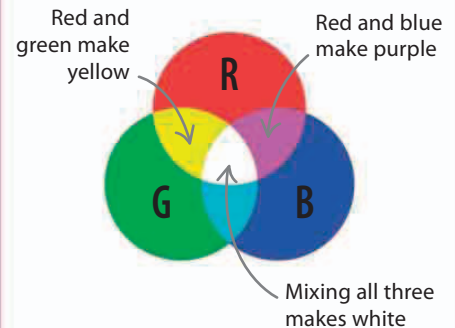

## Drawing on a canvas

To create graphics using Python, you need to make a blank area to draw on. This is known as a canvas. You can use x and y coordinates to tell Python exactly where to draw on the canvas.

### 1 Create a graphics program

Use this code to create a window and put a canvas inside it. It will then draw random circles on the canvas.

**EXPERT TIPS**

### Coordinates

In Tkinter, x coordinates get larger moving to the right, and y coordinates get larger moving downward. (0,0) is in the top-left corner.

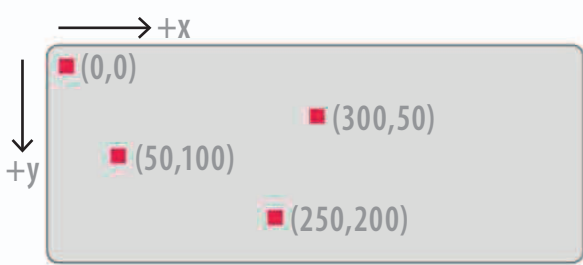

```

from random import *
from tkinter import *
size = 500
window = Tk()
canvas = Canvas(window, width=size, height=size)
canvas.pack()
while True:
    col = choice(['pink', 'orange', 'purple', 'yellow'])
    x0 = randint(0, size)
    y0 = randint(0, size)
    d = randint(0, size/5)
    canvas.create_oval(x0, y0, x0 + d, y0 + d, fill=col)
    window.update()
    
```

This imports the "randint" and "choice" functions from the Random module

This imports all of the Tkinter functions

The variable "size" sets the dimensions of the canvas

A forever loop makes the program draw circles endlessly

This chooses a random color from the list

This creates a circle of a random size in a random place on the canvas

This part of the line draws the circle

This creates a canvas inside a window

This part fills it with the color that has been chosen ("col")

### 2 Colored canvas

Run the code and the program will start drawing circles on the canvas.



Circles are drawn in random places

The size of each circle is random

This part fills it with the color that has been chosen ("col")

# Making shapes

As well as adding windows, buttons, and colors to a graphical user interface (GUI), Tkinter can also be used to draw shapes.

## SEE ALSO

Changing **160–161** ›  
things

Reacting **162–163** ›  
to events

## Creating basic shapes

Rectangles and ovals are useful shapes for drawing all sorts of things. Once a canvas has been created, the following functions can be used to draw shapes on it.

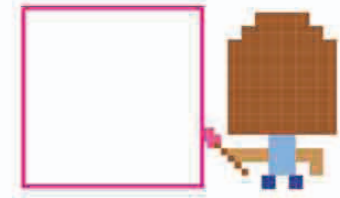

```
>>> from tkinter import *
>>> window = Tk()
>>> drawing = Canvas(window, height=500, width=500)
>>> drawing.pack()
>>> rect1 = drawing.create_rectangle(100, 100, 300, 200)
>>> square1 = drawing.create_rectangle(30, 30, 80, 80)
>>> oval1 = drawing.create_oval(100, 100, 300, 200)
>>> circle1 = drawing.create_oval(30, 30, 80, 80)
```

Creates a canvas to draw on

Sets the size of the canvas

Sets the position and size of the rectangle using coordinates (see below)

Draws a rectangle

A square can be made by drawing a rectangle with all sides the same length

Draws a circle

Sets the position and size of the circle

## Drawing with coordinates

Coordinates are used to tell the computer exactly where to create shapes. The first number (“x”) tells the computer how far along the screen to go. The second number (“y”) tells the computer how far down to go.

### ▽ Coordinates grid

The top-left corner of the rectangle is at coordinates (50, 50). The bottom-right corner is at (250, 350).

```
>>> drawing.create_rectangle(50, 50, 250, 350)
```

This is the name of the canvas

Coordinates for the top left of the rectangle

Coordinates for the bottom right of the rectangle

### △ Setting the coordinates

The first two numbers give the coordinates for the top-left corner of the rectangle. The second two numbers locate the bottom-right corner.

(x1=50, y1=50)

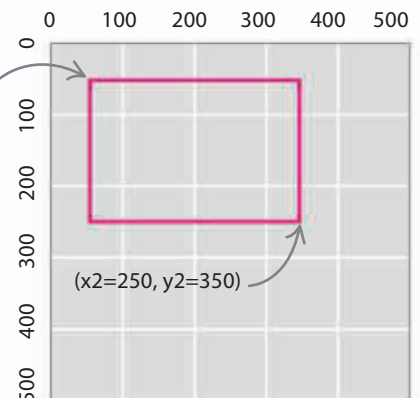



## Adding color to shapes

It's also possible to create colored shapes. Code can be used to set different colors for the outline and the inside ("fill") of each shape.

Creates a solid blue circle with a red outline

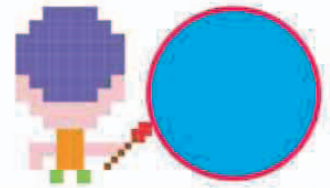

```
>>> drawing.create_oval(30, 30, 80, 80, outline='red', fill='blue')
```

## Draw an alien

You can draw almost anything by combining different shapes. Here are some instructions for creating an alien using ovals, lines, and triangles.

### 1 Create the alien

For each part of the alien, you must define the type of shape, size, position on the canvas, and color. Each shape has a unique ID number that can be stored in a variable.

```
from tkinter import *
window = Tk()
window.title('Alien')
c = Canvas(window, height=300, width=400)
c.pack()
body = c.create_oval(100, 150, 300, 250, fill='green')
eye = c.create_oval(170, 70, 230, 130, fill='white')
eyeball = c.create_oval(190, 90, 210, 110, fill='black')
mouth = c.create_oval(150, 220, 250, 240, fill='red')
neck = c.create_line(200, 150, 200, 130)
hat = c.create_polygon(180, 75, 220, 75, 200, 20, fill='blue')
```

Sets "Alien" as the title of the window

Creates the canvas

Draws a green oval for the body

Draws a black dot inside the eye

Draws a red oval for the mouth

Draws a blue triangle for the alien's hat

### 2 Meet the alien

Run the code to draw the alien. It has a green body, a red mouth, and one eye on a stalk. It's also wearing a lovely blue hat.

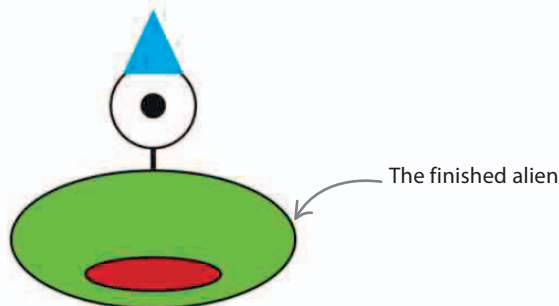

# Changing things

Once a graphic has been drawn on the canvas, it doesn't need to stay the same. Code can be used to change the way it looks, or move it around the screen.

## SEE ALSO

◀ 158–159 Making shapes

Reacting to 162–163 ▶  
events

## Moving shapes

To make a shape move on the canvas, you need to tell the computer what to move (the name or ID you gave the shape) and where to move it.

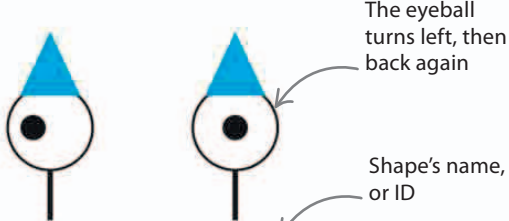

The eyeball turns left, then back again

Shape's name, or ID

```
>>> c.move(eyeball, -10, 0)
>>> c.move(eyeball, 10, 0)
```

This function moves shapes

Sets coordinates for the movement



## REMEMBER

### Meaningful names

It's a good idea to use sensible names to identify the shapes on the canvas. These pages use names like "eyeball" and "mouth" so the code is easy to read and understand.

### ◁ Moving eyeballs

Type this code into the shell window to make the eyeball turn to the left, then turn back again.

## Changing colors

You can make the mouth look as though it is opening and closing by simply changing the color of the oval.

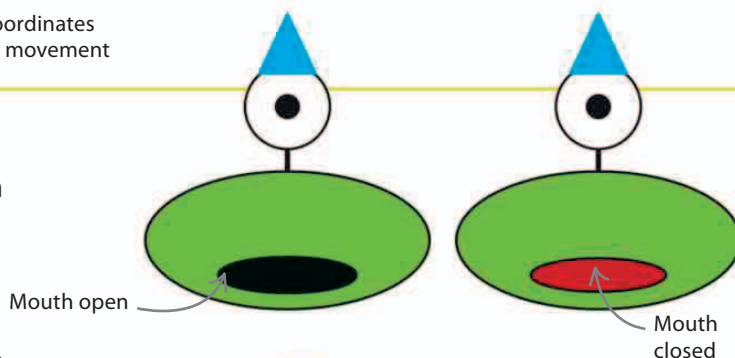

**1 Write the code**  
Type this code to create two functions that will make the mouth seem to open and close.

The function "itemconfig()" changes the properties of shapes you've already drawn

The opened mouth will be black

```
def mouth_open():
    c.itemconfig(mouth, fill='black')
def mouth_close():
    c.itemconfig(mouth, fill='red')
```

The shape's ID

The closed mouth will be red

### 2 Open and close

Type this code into the shell window to make the mouth open and close.

```
>>> mouth_open()
>>> mouth_close()
```

Enter these commands to make the alien open and close its mouth

## Hide and show

Shapes can be hidden using the "itemconfig()" function. If you hide the eyeball, and then show it again a moment later, the alien looks as though it is blinking.

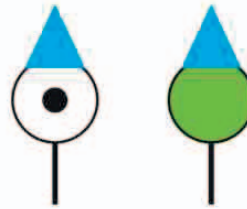

◁ **Blinking alien**  
To make the alien blink, you need to hide the pupil and make the white of the eye green.

**1 Create blinking functions**  
This code creates two functions so you can make the alien blink.

```
def blink():
    c.itemconfig(eye, fill='green')
    c.itemconfig(eyeball, state=HIDDEN)
def unblink():
    c.itemconfig(eye, fill='white')
    c.itemconfig(eyeball, state=NORMAL)
```

Turns the white of the eye green

The shape's ID

Makes the eye white again

**2 Blink and unblink**  
Type this code into the shell window to make the alien blink.

```
>>> blink()
>>> unblink()
```

Hides the pupil

The "unblink()" command makes the eye appear open again

Reveals the pupil

## Saying things

Text can also be displayed on the screen to make the alien talk. You can even make it say different things in response to user commands.

**1 Adding text**  
This code adds text to the graphic of the alien and creates a function to steal its hat.

```
words = c.create_text(200, 280, text='I am an alien!')
def steal_hat():
    c.itemconfig(hat, state=HIDDEN)
    c.itemconfig(words, text='Give my hat back!')
```

Positions the text on the canvas

I am an alien!

Put what you want the alien to say in quote marks

This hides the hat

As soon as the hat disappears the alien will ask for it back

A new message appears when the hat disappears

Give my hat back!

**2 Steal the hat**  
Type this code into the shell window and see what happens.

```
>>> steal_hat()
```

Type this to steal the hat

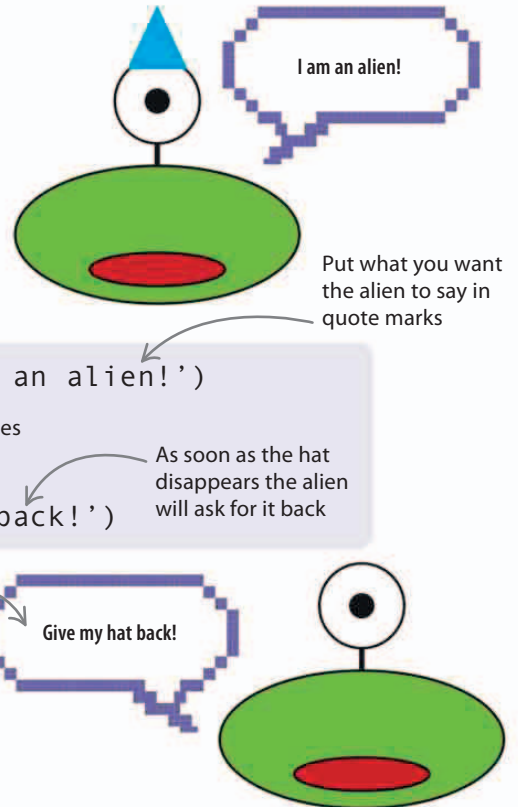

# Reacting to events

Computers receive a signal when a key is pressed or a mouse is moved. This is called an “event”. Programs can instruct the computer to respond to any events it detects.

## SEE ALSO

◀ 158–159 Making shapes

◀ 160–161 Changing things

## Event names

Lots of different events can be triggered using input devices like a mouse or keyboard. Tkinter has names to describe each of these events.



## Mouse events

**<Button-1>**  
Left mouse button clicked

**<Button-3>**  
Right mouse button clicked

Spacebar pressed

## Keyboard events

**<Right>**  
Right arrow key pressed

**<Left>**  
Left arrow key pressed

**<space>**

**<Up>**  
Up arrow key pressed

**<Down>**  
Down arrow key pressed

“A” key pressed

Different letters can go here  
**<KeyPress-a>**

## Mouse events

To make a program respond to mouse events, simply link (or bind) a function to an event. Here, the function “burp” is created, then bound to the “<Button-1>” event.

```

window.attributes('-topmost', 1)
def burp(event):
    mouth_open()
    c.itemconfig(words, text='Burp!')
c.bind_all('<Button-1>', burp)

```

This brings the Tkinter window to the front of your screen

Creates a function called “burp”

Links the left mouse click to the “burp” function

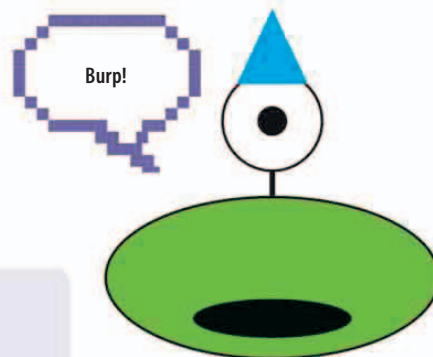

### △ Burping alien

Click the left mouse button and the alien lets out a burp. This is because the “burp” function has been used.

## Key events

Functions can also be bound to keys on the keyboard in the same way. Type in the code below to make the alien blink when the “A” and “Z” keys are pressed.

```
def blink2(event):
    c.itemconfig(eye, fill='green')
    c.itemconfig(eyeball, state=HIDDEN)
def unblink2(event):
    c.itemconfig(eye, fill='white')
    c.itemconfig(eyeball, state=NORMAL)
c.bind_all('<KeyPress-a>', blink2)
c.bind_all('<KeyPress-z>', unblink2)
```

Makes the eye green (closed)

Hides the eyeball

Shows the eyeball

This code links functions to events

This binds the function “unblink2” to the “Z” key

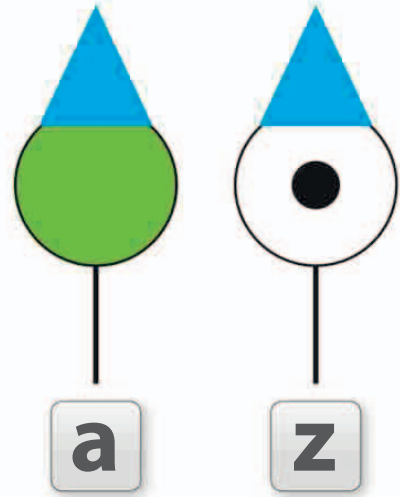

### △ Make the alien blink

When this code is run, the “A” key will make the eye close, and the “Z” key will make it open again.

## Moving with keys

Key presses can also be used to trigger movement. This code binds the arrow keys to functions that make the alien’s eyeball move.

```
def eye_control(event):
    key = event.keysym
    if key == "Up":
        c.move(eyeball, 0, -1)
    elif key == "Down":
        c.move(eyeball, 0, 1)
    elif key == "Left":
        c.move(eyeball, -1, 0)
    elif key == "Right":
        c.move(eyeball, 1, 0)
c.bind_all('<Key>', eye_control)
```

This line finds out the name of the pressed key

The eyeball moves up if the up arrow key is pressed

The eyeball moves left if the left arrow key is pressed

Activates the function “eye\_control” when any key is pressed

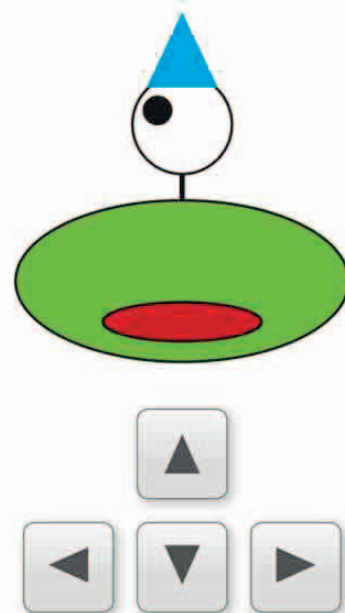

### △ Eyeball control

The eyeball moves in the direction of the pressed arrow key.

## PROJECT 7

# Bubble blaster

This project uses all the skills taught in this chapter to make a game. It's a big project, so tackle it in stages and remember to save the program regularly. Try to understand how each part fits together before moving on to the next stage. By the end you'll have a game that you can play and share with friends.

## Aim of the game

Before writing any code, think about the overall plan for the game and how it should work. Here are the main rules that set out how the game will be played:

**The player controls a submarine**

**The arrow keys move the submarine**

**Popping bubbles scores points**

**A timer is set to 30 seconds at the start**

**Scoring 1,000 points earns extra time**

**The game ends when the time runs out**

### SEE ALSO

◀ **154–155** Making windows

◀ **156–157** Color and coordinates

◀ **158–159** Making shapes

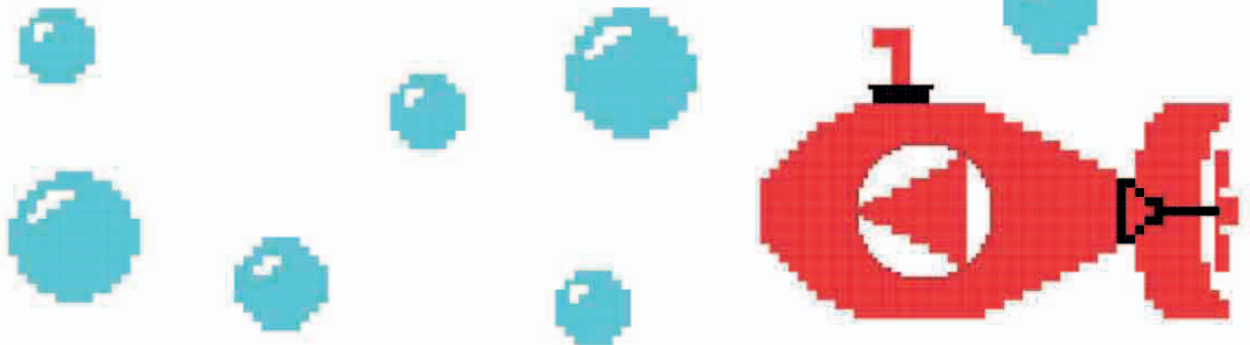

## Create the game window and the submarine

Start by setting the scene. Open a new code window in IDLE. Type in the code below to create the window for the game, and the submarine that the player controls.

- 1** Use the Tkinter library to build the graphical user interface (GUI). This code will create the main window for the game.

```
from tkinter import *
HEIGHT = 500
WIDTH = 800
window = Tk()
window.title('Bubble Blaster')
c = Canvas(window, width=WIDTH, height=HEIGHT, bg='darkblue')
c.pack()
```

Imports all of the Tkinter functions

Sets the size of the window

Give the game a snappy title

Sets dark blue as the color of the background (the sea)

Creates a canvas that can be drawn on

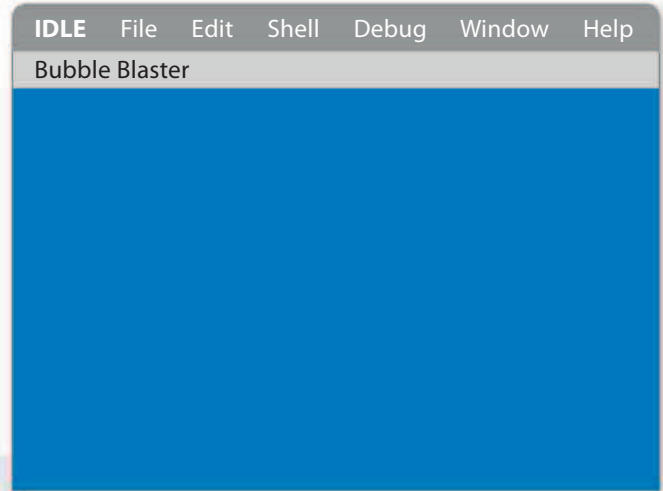

- 2** A simple graphic will represent the submarine in this game. This can be made using some of the drawing functions from Tkinter. Type out this code, then run it.

```
ship_id = c.create_polygon(5, 5, 5, 25, 30, 15, fill='red')
ship_id2 = c.create_oval(0, 0, 30, 30, outline='red')
SHIP_R = 15
MID_X = WIDTH / 2
MID_Y = HEIGHT / 2
c.move(ship_id, MID_X, MID_Y)
c.move(ship_id2, MID_X, MID_Y)
```

The radius (size) of the submarine

The variables "MID\_X" and "MID\_Y" give the coordinates of the middle of the screen

Draws a red triangle for the submarine

Draws a red circle outline

Moves both parts of the submarine to the center of the screen

The submarine will be represented by a triangle inside a circle



Don't forget to save your work



## BUBBLE BLASTER

### Controlling the submarine

The next stage of the program is to write the code that makes the submarine move when the arrow keys are pressed. The code will create a function called an “event handler”. The event handler checks which key has been pressed and moves the submarine.

**3** Type this code to create a function called “move\_ship”. This function will move the submarine in the correct direction when a cursor key is pressed. Try running it to see how it works.

```
SHIP_SPD = 10
def move_ship(event):
    if event.keysym == 'Up':
        c.move(ship_id, 0, -SHIP_SPD)
        c.move(ship_id2, 0, -SHIP_SPD)
    elif event.keysym == 'Down':
        c.move(ship_id, 0, SHIP_SPD)
        c.move(ship_id2, 0, SHIP_SPD)
    elif event.keysym == 'Left':
        c.move(ship_id, -SHIP_SPD, 0)
        c.move(ship_id2, -SHIP_SPD, 0)
    elif event.keysym == 'Right':
        c.move(ship_id, SHIP_SPD, 0)
        c.move(ship_id2, SHIP_SPD, 0)
c.bind_all('<Key>', move_ship)
```

The sub will move this far when a key is pressed

Moves the two parts of the sub up when the up arrow key is pressed

These lines are activated when the down arrow key is pressed, and the sub moves down

The sub moves left when the left arrow key is pressed

Moves the sub right when the right arrow key is pressed

y coordinate gets smaller moving up

Tells Python to run “move\_ship” whenever any key is pressed



Don't forget to save your work

#### ► How it works

The “move\_ship” function moves the sub in different directions. Adding to the sub’s x and y coordinates moves it right and down, while subtracting from them moves it left and up.

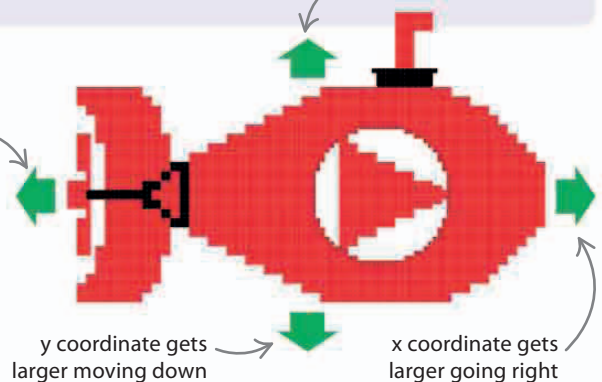



## Get ready for bubbles

Now the submarine can move, start creating the bubbles for the player to pop. Each bubble will be a different size and move at a different speed.

- 4 Every bubble needs an ID number (so the program can identify each specific bubble), a size, and a speed.

```

from random import randint
bub_id = list()
bub_r = list()
bub_speed = list()
MIN_BUB_R = 10
MAX_BUB_R = 30
MAX_BUB_SPD = 10
GAP = 100
def create_bubble():
    x = WIDTH + GAP
    y = randint(0, HEIGHT)
    r = randint(MIN_BUB_R, MAX_BUB_R)
    id1 = c.create_oval(x - r, y - r, x + r, y + r, outline='white')
    bub_id.append(id1)
    bub_r.append(r)
    bub_speed.append(randint(1, MAX_BUB_SPD))
  
```

This creates three empty lists used to store the ID, radius (size), and speed of each bubble

Sets the minimum radius of the bubble to 10, and the maximum to 30

Sets the position of the bubble on the canvas

Picks a random size for the bubble, between the minimum and maximum values possible

This line of code creates the bubble shape

Adds the ID, radius, and speed of the bubble to the three lists

### EXPERT TIPS

#### Bubble lists

Three lists are used to store information about each bubble. The lists start off empty, and information about each bubble is then added as you create it. Each list stores a different bit of information.

**bub\_id:** stores the ID number of the bubble so the program can move it later.

**bub\_r:** stores the radius (size) of the bubble.

**bub\_speed:** stores how fast the bubble travels across the screen.



Don't forget to save your work



## BUBBLE BLASTER

### Make the bubbles move

There are now lists to store the ID, size, and speed of the bubbles, which are randomly generated. The next stage is to write the code that makes the bubbles move across the screen.

**5** This function will go through the list of bubbles and move each one in turn.

```
def move_bubbles():
    for i in range(len(bub_id)):
        c.move(bub_id[i], -bub_speed[i], 0)
```

Goes through each bubble in the list

Moves the bubble across the screen according to its speed

Imports the functions you need from the Time library

**6** This will be the main loop for the game. It will be repeated over and over while the game is running. Try running it!



Don't forget to save your work

```
from time import sleep, time
BUB_CHANCE = 10
#MAIN GAME LOOP
while True:
    if randint(1, BUB_CHANCE) == 1:
        create_bubble()
    move_bubbles()
    window.update()
    sleep(0.01)
```

Generates a random number from 1 to 10

If the random number is 1, the program creates a new bubble (on average 1 in 10 times – so there aren't too many bubbles!)

Runs the "move\_bubbles" function

Updates the window to redraw bubbles that have moved

Slows the game down so it's not too fast to play

**7** Now you're going to create a useful function to find out where a particular bubble is, based on the ID. This code should be added to the program directly after the code you created in step 5.

```
def get_coords(id_num):
    pos = c.coords(id_num)
    x = (pos[0] + pos[2])/2
    y = (pos[1] + pos[3])/2
    return x, y
```

Works out the x coordinate of the middle of the bubble

Works out the y coordinate of the middle of the bubble

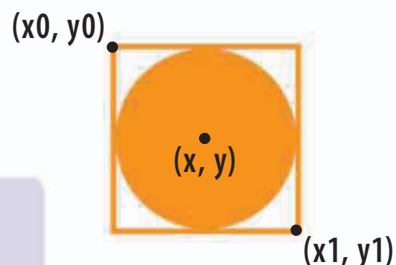

#### △ Locating bubbles

The function finds the middle of the bubble by taking the point halfway between the corners of the box around it.

## How to make bubbles pop

The player will score points when the bubbles are popped, so the program has to make bubbles disappear from the screen. These next functions will allow it to do that.

**8** This function will be used to remove a bubble from the game. It does this by deleting it from all the lists, and from the canvas. This code should be added directly after the code you typed out in step 7.

```
def del_bubble(i):
    del bub_r[i]
    del bub_speed[i]
    c.delete(bub_id[i])
    del bub_id[i]
```

This function deletes the bubble with ID "i"

Deletes the bubble from the radius and speed lists

Deletes the bubble from the canvas

Deletes the bubble from the ID list

**9** Type this code to create a function that cleans up bubbles that have floated off the screen. This code should go directly after the code from step 8.

```
def clean_up_bubs():
    for i in range(len(bub_id)-1, -1, -1):
        x, y = get_coords(bub_id[i])
        if x < -GAP:
            del_bubble(i)
```

This goes through the bubble list backward to avoid the "for" loop causing an error when bubbles are deleted

Finds out where the bubble is

If the bubble is off the screen then it is deleted; otherwise, it would slow the game down

**10** Now update the main game loop (from step 6) to include the helpful functions you have just created. Run it to make sure you haven't included any errors.

```
#MAIN GAME LOOP
while True:
    if randint(1, BUB_CHANCE) == 1:
        create_bubble()
    move_bubbles()
    clean_up_bubs()
    window.update()
    sleep(0.01)
```

Makes a new bubble

Updates the positions of all the bubbles

Redraws the window to show the changes

Removes bubbles that are off the screen



Don't forget to save your work



## BUBBLE BLASTER

### Figuring out the distance between points

In this game, and lots of others, it is useful to know the distance between two objects. Here's how to use a well-known mathematical formula to have the computer work it out.

**11** This function calculates the distance between two objects. Add this bit of code directly after the code you wrote in step 9.

```
from math import sqrt
def distance(id1, id2):
    x1, y1 = get_coords(id1)
    x2, y2 = get_coords(id2)
    return sqrt((x2 - x1)**2 + (y2 - y1)**2)
```

Loads the "sqrt" function from the Math library

Gets the position of the first object

Gets the position of the second object

Gives back the distance between them

### Pop the bubbles

The player scores points by popping bubbles. Big bubbles and fast bubbles are worth more points. The next section of code works out when each bubble is popped by using its radius (the distance from the center to the edge).

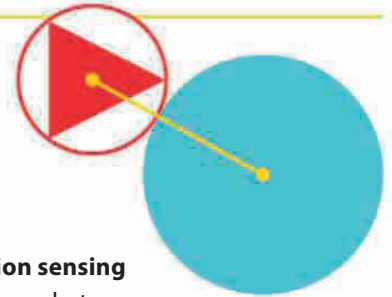

#### ▷ Collision sensing

If the distance between the center of the sub and the center of a bubble is less than their radiuses added together, they have collided.

**12** When the submarine and a bubble crash into each other, the program needs to pop the bubble and update the score. This bit of code should come directly after the code in step 11.

```
def collision():
    points = 0
    for bub in range(len(bub_id)-1, -1, -1):
        if distance(ship_id2, bub_id[bub]) < (SHIP_R + bub_r[bub]):
            points += (bub_r[bub] + bub_speed[bub])
            del_bubble(bub)
    return points
```

This variable keeps track of points scored

This loop goes through the entire list of bubbles (it goes backwards to avoid errors when deleting bubbles)

Checks for collisions between the sub and any bubbles

Deletes the bubble

Calculates the number of points this bubble is worth and adds it to "points"

Gives back the number of points

- 13** Now update the main game loop to use the functions you have just created. Remember that the order is important, so make sure you put everything in the right place. Then run the code. Bubbles should burst when they hit the sub. Check the shell window to see the score.

```
score = 0
#MAIN GAME LOOP
while True:
    if randint(1, BUB_CHANCE) == 1:
        create_bubble()
    move_bubbles()
    clean_up_bubs()
    score += collision()
    print(score)
    window.update()
    sleep(0.01)
```

← Sets the score to zero when the game starts

← Creates new bubbles

← Adds the bubble score to the total

← Shows the score in the shell window—it will be displayed properly later

← This pauses the action for a very short time—try removing this and see what happens

### EXPERT TIPS

## Python shortcut

The code “score += collision()” is a shortcut for writing “score = score + collision()”. It adds the collision score to the total score, then updates the total score. Code like this is common, so a shortcut is useful. You can also do the same thing using the “-” symbol. For example, “score -= 10” is the same as “score = score - 10”.



Don't forget to save your work



## BUBBLE BLASTER

### Adding a few final touches

The main stages of the game are now working. All that remains is to add the final parts: displaying the player's score, and setting a time limit that counts down until the game ends.

- 14** Type in this code after the code you entered in step 12. It tells the computer to display the player's score and the time left in the game.

```
c.create_text(50, 30, text='TIME', fill='white' )
c.create_text(150, 30, text='SCORE', fill='white' )
time_text = c.create_text(50, 50, fill='white' )
score_text = c.create_text(150, 50, fill='white' )
def show_score(score):
    c.itemconfig(score_text, text=str(score))
def show_time(time_left):
    c.itemconfig(time_text, text=str(time_left))
```

Creates "TIME" and "SCORE" labels to explain to the player what the numbers mean

Sets the scores and time remaining

Displays the score

Displays the time remaining

- 15** Next, set up the time limit and the score required to gain bonus time, and calculate the end time of the game. This bit of code should come just before the main game loop.

```
from time import sleep, time
BUB_CHANCE = 10
TIME_LIMIT = 30
BONUS_SCORE = 1000
score = 0
bonus = 0
end = time() + TIME_LIMIT
```

Imports functions from the Time library

Starts the game with a 30-second time limit

Sets when bonus time is given (when a player has scored 1,000 points)

Stores the finish time in a variable called "end"

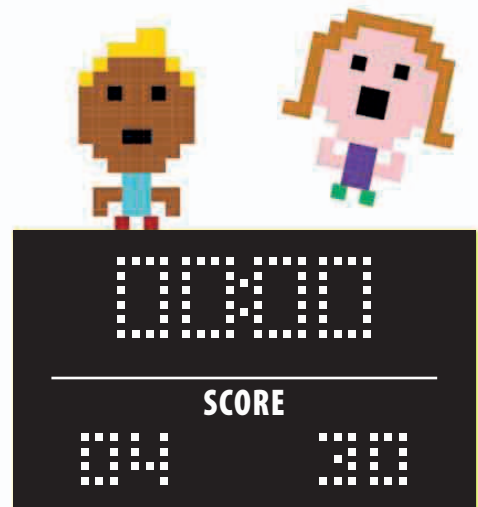

#### △ Scoreboard

Scoreboards are a great visual way to show players at a glance how well they are doing in a game.

16

Update the main game loop to include the new score and time functions.



Don't forget to save your work

```
#MAIN GAME LOOP
```

```
while time() < end:
```

```
    if randint(1, BUB_CHANCE) == 1:
```

```
        create_bubble()
```

```
    move_bubbles()
```

```
    clean_up_bubs()
```

```
    score += collision()
```

```
    if (int(score / BONUS_SCORE)) > bonus:
```

```
        bonus += 1
```

```
        end += TIME_LIMIT
```

```
    show_score(score)
```

```
    show_time(int(end - time()))
```

```
    window.update()
```

```
    sleep(0.01)
```

Repeats the main game loop until the game ends

Calculates when to give bonus time

"print(score)" has been replaced by "show\_score(score)" so that the score now appears in the game window

Displays the time remaining

17

Finally, add a "GAME OVER" graphic. This will be shown when the time runs out. Add this to the very bottom of your program.

```
c.create_text(MID_X, MID_Y, \
```

```
    text='GAME OVER', fill='white', font=('Helvetica',30))
```

```
c.create_text(MID_X, MID_Y + 30, \
```

```
    text='Score: ' + str(score), fill='white')
```

```
c.create_text(MID_X, MID_Y + 45, \
```

```
    text='Bonus time: ' + str(bonus*TIME_LIMIT), fill='white')
```

Puts graphic in the middle of the screen

Sets the font—"Helvetica" is a good font for big letters

Tells you what your score was

Sets the text color to white

Shows how much bonus time was earned



Don't forget to save your work



## BUBBLE BLASTER

### Time to play

Well done! You've finished writing Bubble blaster and it's now ready to play. Run the program and try it out. If something isn't working, remember the debugging tips—look back carefully over the code on the previous pages to make sure everything is typed out correctly.

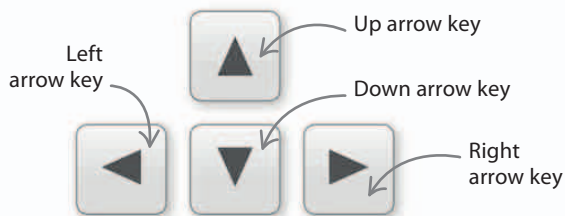

#### △ Controls

The submarine is steered using the arrow keys. The program can be adjusted so it works with other controls.



#### EXPERT TIPS

### Improving your game

All computer games start as a basic idea. They are then played, tested, adjusted, and improved. Think of this as version one of your game. Here are some suggestions of how you could change and improve it with new code:

**Make the game harder** by adjusting the time limit and the score required for bonus time.

**Choose a different color** for your submarine.

**Create a more detailed** submarine graphic.

**Have a special type of bubble** that increases the speed of the submarine.

**Add a smart bomb** that deletes all of the bubbles when you press the spacebar.

**Build a leaderboard** to keep track of the best scores.

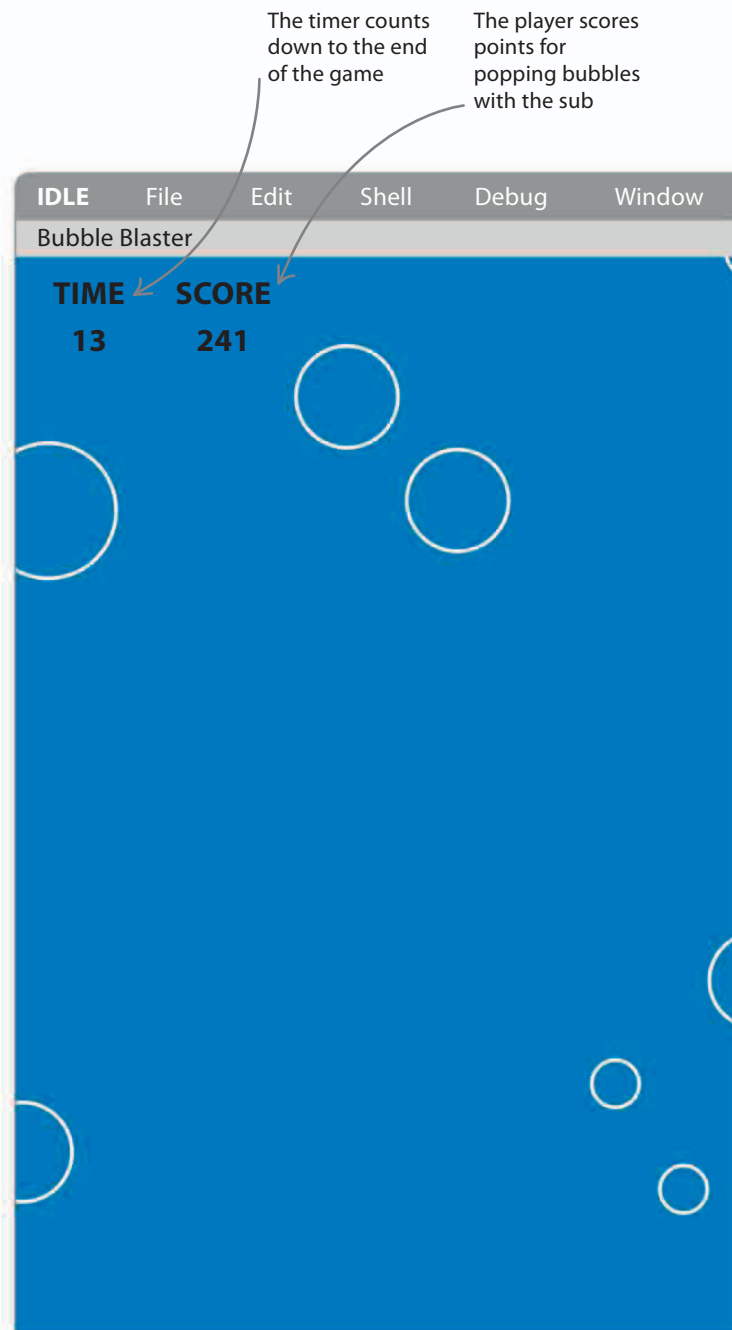



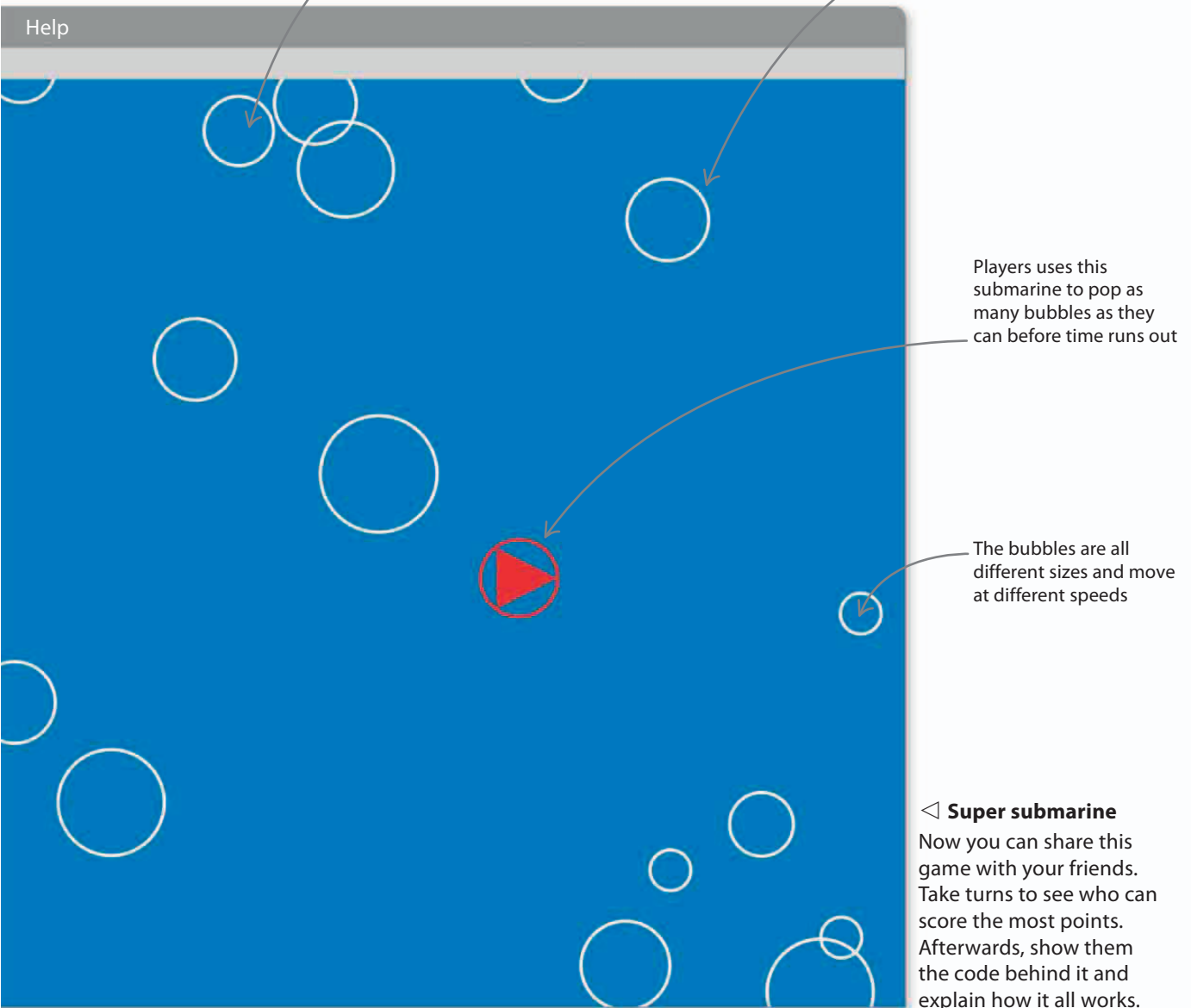

# What next?

Now that you've tackled the Python projects in this book, you're on your way to becoming a great programmer. Here are some ideas for what to do next in Python, and how to take your programming skills further.

## SEE ALSO

◀ 152–153 Libraries

Computer 204–205 ▶  
games

## Experiment

Play around with the code samples in this book. Find new ways to remix them or add new features—and don't be afraid to break them too! This is your chance to experiment with Python. Remember that it is a professional programming language with a lot of power—you can do all sorts of things with it.

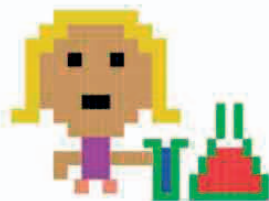

## REMEMBER

### Read lots of code

Find interesting programs or libraries written by other people and read through the code and their comments. Try to understand how the code works, and why it is built that way. This increases your knowledge of coding practices. You will also learn useful bits of information about libraries that you can use in future programs.



## Build your own libraries

Programmers love to reuse code and share their work. Create your own library of useful functions and share it. It's a great feeling to see your code being used by another programmer. You might build something as useful as Tkinter or Turtle!

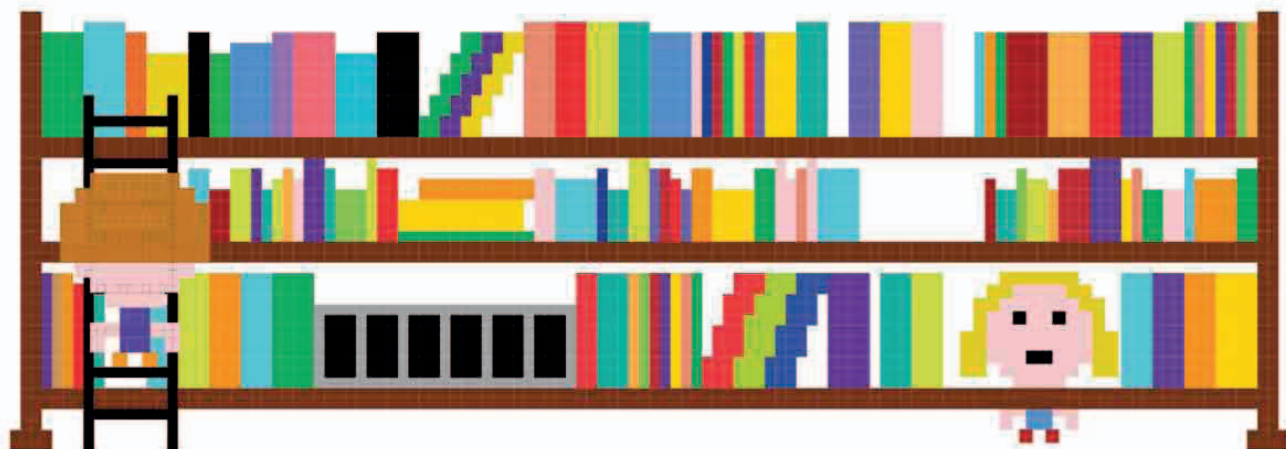

## Make games with Python

You could create your own game using Python. The PyGame library, which is available to download from the web, comes with lots of functions and tools that make it easier to build games. Start by making simple games, then progress to more complex ones.



### EXPERT TIPS

#### Different versions of Python

When you find code elsewhere (in other books or online), it may be written for a different version of Python. The versions are similar, but you might need to make small changes.

```
print 'Hello World'
```

Python 2

```
print('Hello World')
```

Python 3

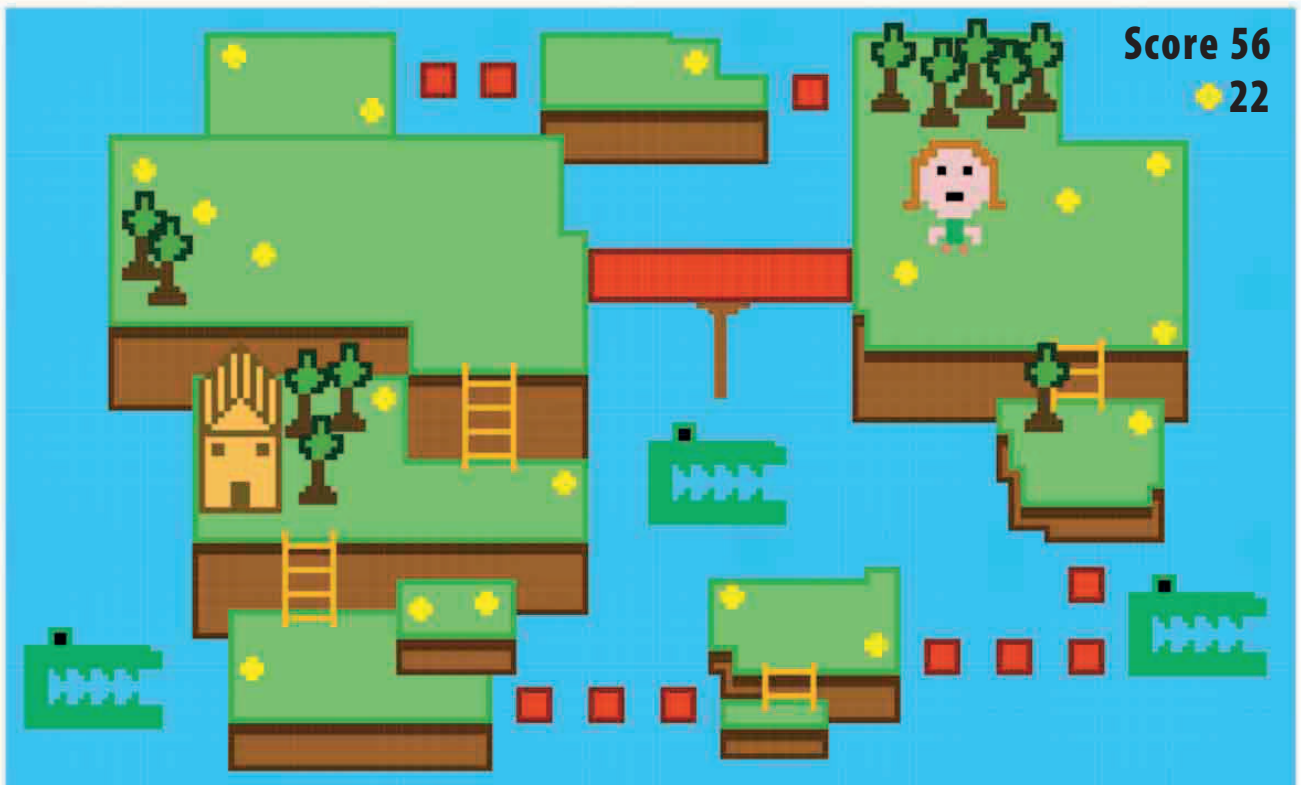

## Debug your code

Debugging is an important part of programming. Don't just give up if something isn't working. Remember that computers will only do what you tell them, so look through the code and figure out why it's not working. Sometimes looking over it with another programmer helps you find bugs quicker.

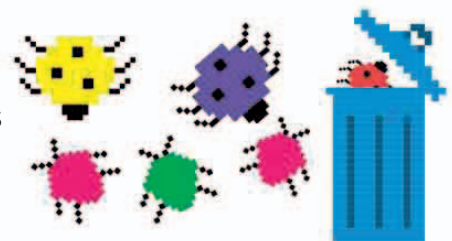

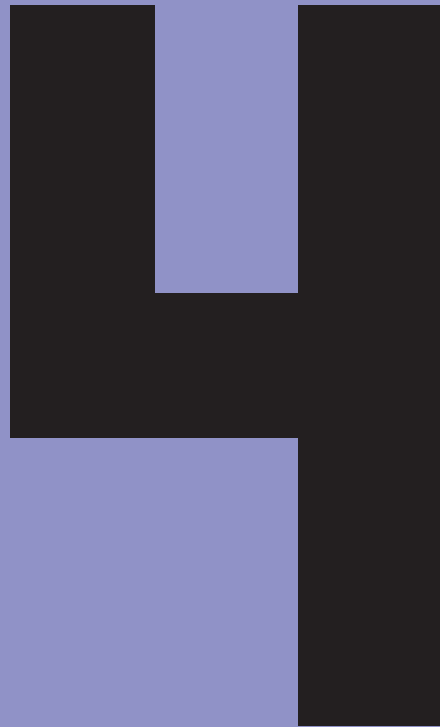

# Inside computers

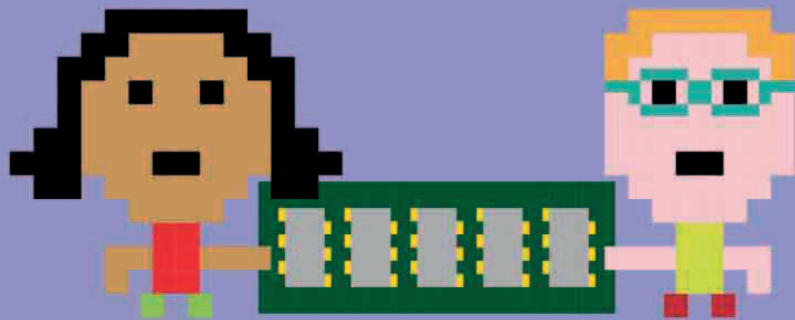

# Inside a computer

The earliest computers were simple calculators. At a basic level, computers haven't changed much since then. They take in data (input), perform calculations, and give out answers (output).

## Basic elements

A computer consists of four main parts: input, memory, processor, and output. Input devices gather data, similar to the way your eyes or ears collect information about the world around you. Memory stores the data, while processors examine and alter it, just like a human brain. Output devices show the results of the processor's calculations, like a person speaking or moving after deciding what to do.

### ▷ Von Neumann architecture

A scientist called John von Neumann first came up with the standard layout for a computer in 1945. His plan is still followed today, with some improvements.

## Input

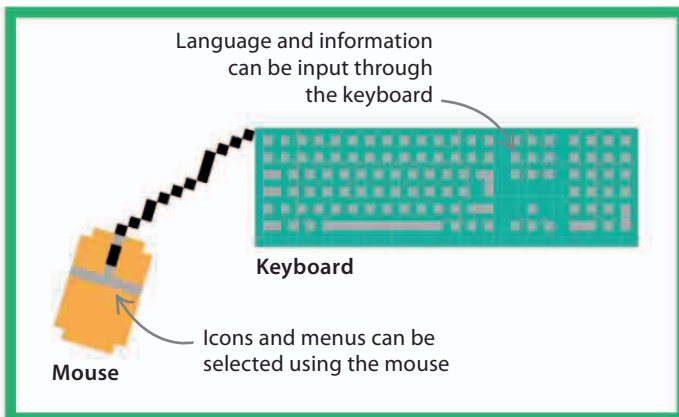

The memory contains information in sections, like books on library shelves. Memory is used to store programs and the data they use

## Memory

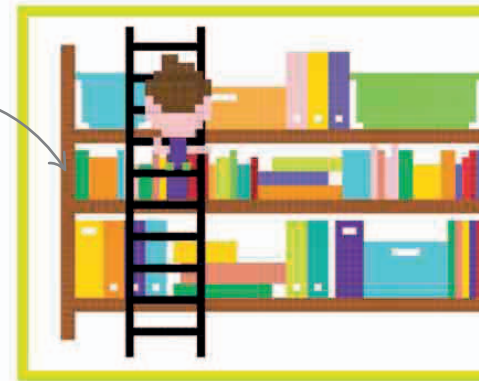

The control unit loads and carries out instructions from programs

## Processor

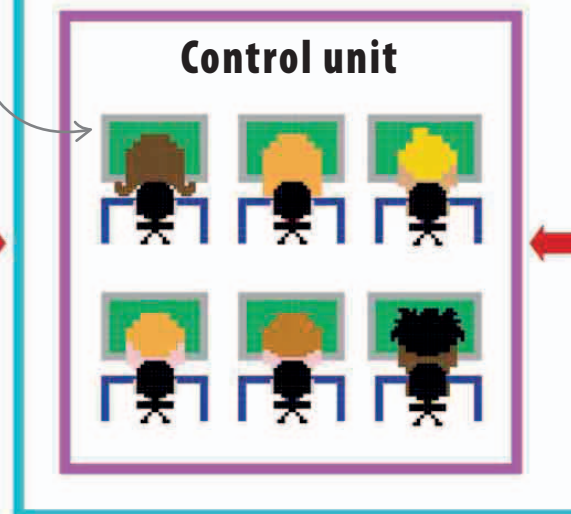

### SEE ALSO

Storing data **192–193** >  
in files

The Internet **194–195** >

Mini **214–215** >  
computers

# Computer hardware

Hardware is the physical parts of a computer. Computers contain many different bits of hardware working together. As computer makers pack more and more features into smaller machines, the hardware components have to be smaller, generate less heat, and use less power.

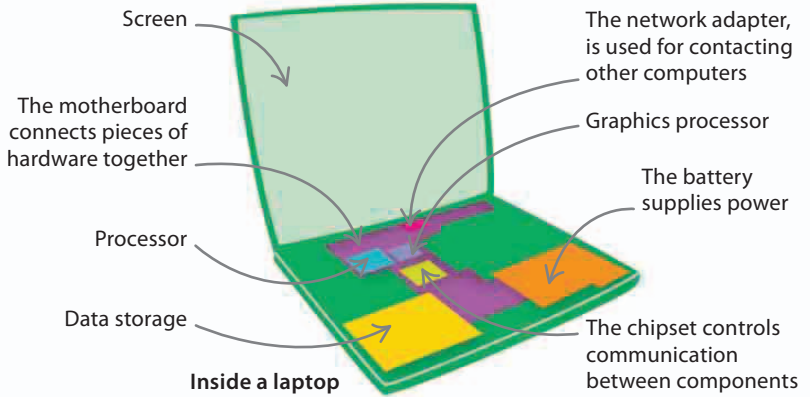

The arithmetic logic unit retrieves data for its calculations from the memory

The processor is made up of two parts, one to carry out instructions and the other to perform calculations

The arithmetic logic unit (ALU) performs any calculations the program needs

**LINGO**

**GIGO**

“Garbage in, garbage out” (“GIGO” for short) is a computing phrase meaning that even the best programs will output nonsense if they receive the wrong input.

**Arithmetic logic unit**

2+3=5

5 > 3 = ?

## Output

Printers output data onto paper

Speakers turn data into sounds

Printer

Screens provide visual output

Screen

Speaker

# Binary and bases

How can computers solve complex calculations when all they understand is electrical signals? Binary numbers are used to translate these signals into numbers.

## SEE ALSO

Symbols **184–185** >  
and codes

Logic gates **186–187** >

## What is a base number?

A “base” is the number of values that can be shown using only one digit. Each extra digit increases the number of values that can be shown by a multiple of the base.

### ▷ Decimal system

The decimal system is the most familiar counting system, and has a base of 10. It can show 10 values with one digit, 100 values with two digits, and 1,000 with three digits.

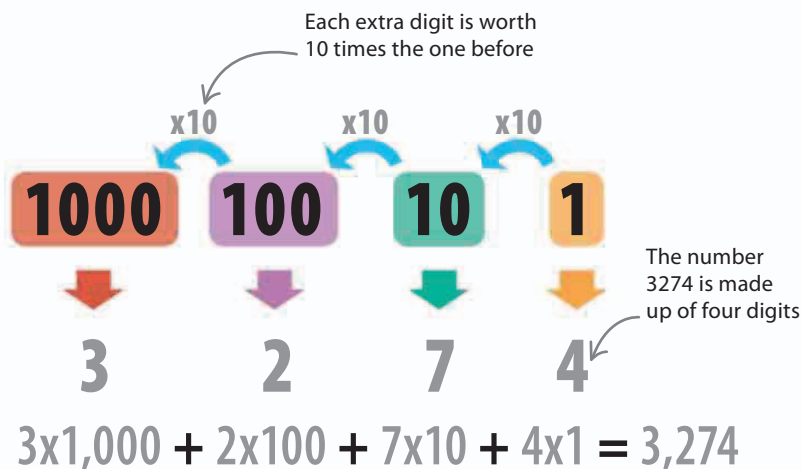

## Binary code

At the most basic level, computers only understand two values: electrical signals that are “on” and “off”. Because there are only two values, computers deal with numbers using a base of two, or “binary”. Each digit is either a 1 or a 0, and each extra digit in the number is worth two times the previous digit.

A wire with a current

### ▷ 1 and 0

A wire with electrical signal “on” is a 1. A wire with electrical signal “off” is a 0.

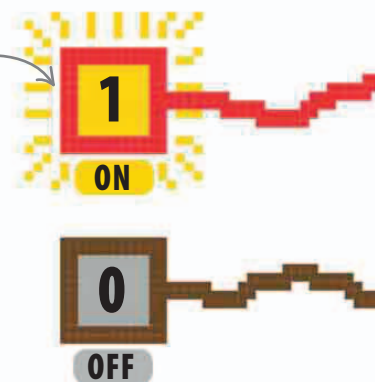

Each extra digit is worth twice as much

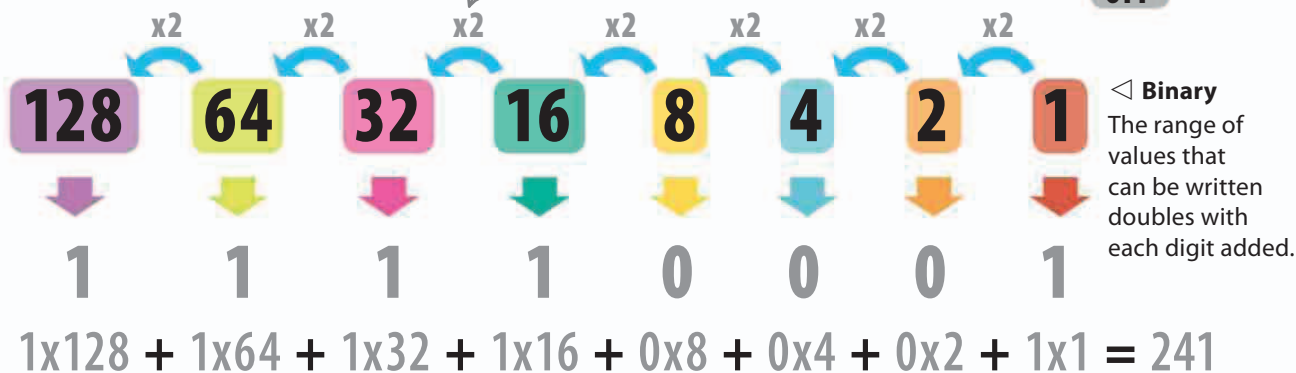



## Hexadecimal

When using numbers in computer programs, a base of 16 is often used because it's easy to translate from binary. Because there are only 10 symbols for numbers (0–9), the values for 10–16 are represented by the letters A–F.

### Understanding nibbles

A “nibble” is made up of four binary digits, which can be represented by one hexadecimal digit.

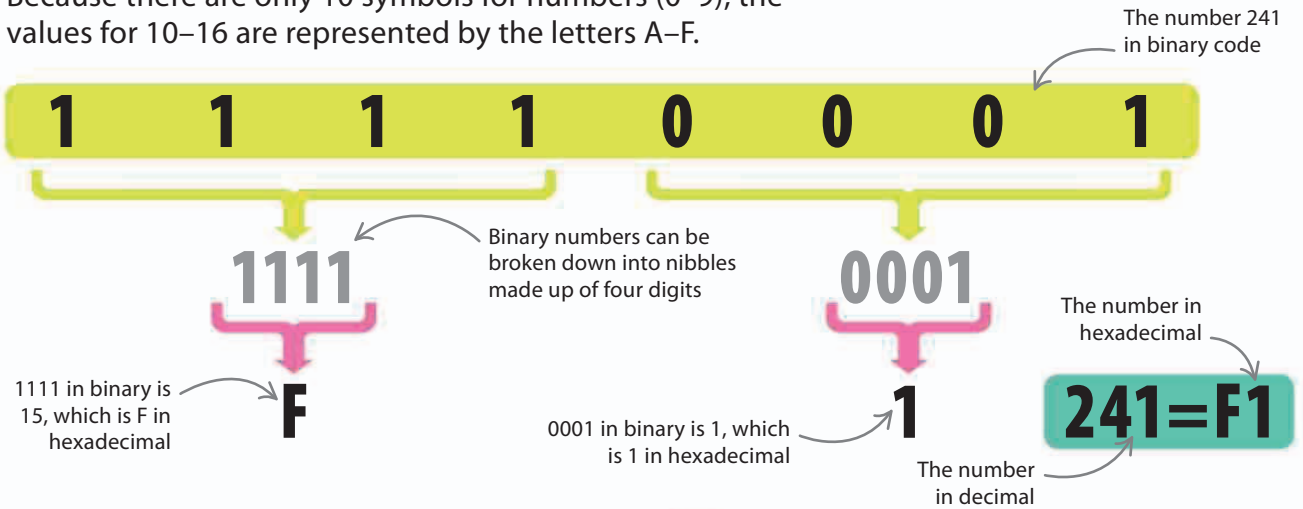

### Comparing base systems

Using this table, you can see that expressing numbers in hexadecimal gives the most information with the fewest digits.

DIFFERENT BASES		
Decimal	Binary	Hexadecimal
0	0 0 0 0	0
1	0 0 0 1	1
2	0 0 1 0	2
3	0 0 1 1	3
4	0 1 0 0	4
5	0 1 0 1	5
6	0 1 1 0	6
7	0 1 1 1	7
8	1 0 0 0	8
9	1 0 0 1	9
10	1 0 1 0	A
11	1 0 1 1	B
12	1 1 0 0	C
13	1 1 0 1	D
14	1 1 1 0	E
15	1 1 1 1	F

**REMEMBER**

### Bits, nibbles, and bytes

A binary digit is known as a “bit”, and is the smallest unit of memory in computing. Bits are combined to make “nibbles” and “bytes”. A kilobit is 1,024 bits. A megabit is 1,024 kilobits.



1

**Bits:** Each bit is a single binary digit—a 1 or 0.



1001

**Nibbles:** Four bits make up a nibble—enough for one hexadecimal digit.

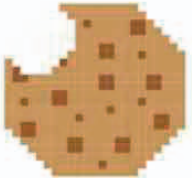

10110010

**Bytes:** Eight bits, or two hexadecimal digits, make up a byte. This gives us a range of values from 0 to 255 (00 to FF).

# Symbols and codes

Computers use binary code to translate numbers into electrical signals. But how would a computer use binary code to store the words and characters on this page?

## ASCII

The first computers each stored characters in their own unique way. This worked fine until data needed to be moved between computers. At this point, a common system was chosen, called the American Standard Code for Information Interchange (ASCII, pronounced “askey”).

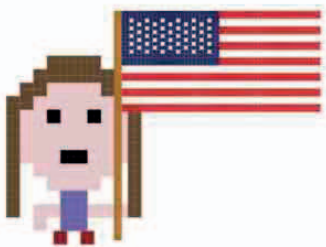

### ▷ ASCII table

In ASCII, a decimal number value is given to each character in the upper- and lower case alphabets. Numbers are also assigned to punctuation and other characters, such as a space.

### ▷ ASCII in binary

Because each character has a number, that number then needs to be converted to binary to be stored in a computer.

**R = 82 = 1010010**

**r = 114 = 1110010**

### ▽ ASCII in Python

You can convert between ASCII and binary code in most languages, including Python.

This command prints the character, the ASCII value, and the binary value for each letter in the name “Sam”

```
>>> name = 'Sam'
>>> for c in name:
    print(c, ord(c), bin(ord(c)))
```

```
S 83 0b1010011
a 97 0b1100001
m 109 0b1101101
```

Here are the results. The beginning of each binary number is marked “0b”

### SEE ALSO

◀ **180–181** Inside a computer

◀ **182–183** Binary and bases

ASCII					
32	SPACE	64	@	96	`
33	!	65	A	97	a
34	"	66	B	98	b
35	#	67	C	99	c
36	\$	68	D	100	d
37	%	69	E	101	e
38	&	70	F	102	f
39	'	71	G	103	g
40	(	72	H	104	h
41	)	73	I	105	i
42	*	74	J	106	j
43	+	75	K	107	k
44	,	76	L	108	l
45	-	77	M	109	m
46	.	78	N	110	n
47	/	79	O	111	o
48	0	80	P	112	p
49	1	81	Q	113	q
50	2	82	R	114	r
51	3	83	S	115	s
52	4	84	T	116	t
53	5	85	U	117	u
54	6	86	V	118	v
55	7	87	W	119	w
56	8	88	X	120	x
57	9	89	Y	121	y
58	:	90	Z	122	z
59	;	91	[	123	{
60	<	92	\	124	
61	=	93	]	125	}
62	>	94	^	126	~
63	?	95	_	127	DELETE

## Unicode

As computers across the world began to share data, the limits of ASCII began to show. Thousands of characters used in hundreds of languages had to be represented, so a universal standard called Unicode was agreed on.

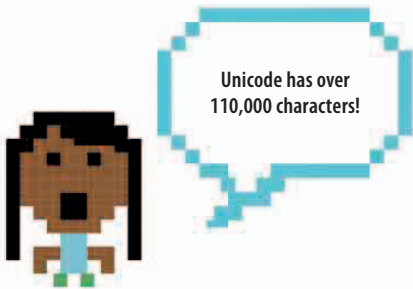

### ▷ International code

Unicode represents all the languages of the world. For example, the Arabic characters are represented in the range 0600–06FF.



### ▷ Unicode characters

Unicode characters are represented by their hexadecimal value, which appears as a series of letters and numbers (see pp.182–183). Each character has its own code. More characters are added all the time, and there are some unusual ones, such as a mini umbrella.



2602



2EC6



08A2



0036



0974



004D



2702



A147

## REMEMBER

### Hexadecimals

Hexadecimal numbers have a base of 16. Ordinary decimal numbers are used for 0 to 9, and the values 10–15 are represented by the letters A to F. Each hexadecimal number has an equivalent binary value.

The Unicode value of ë as hexadecimal

The same value as binary

**ë = 00EB = 11100111**

### ▽ Unicode in Python

Unicode can be used to display special characters in Python. Simply type a string containing a Unicode character code.

Putting “\u” before the hexadecimal code tells the computer this is Unicode

```
>>> 'Zo\u00EB'
'Zoë'
```

The code is translated into the character “ë”

# Logic gates

Computers use electrical signals not only to understand numbers and letters but also to make decisions using devices called “logic gates”. There are four main types of logic gates: “AND”, “NOT”, “OR”, and “EXCLUSIVE OR”.

## SEE ALSO

◀ 180–181 Inside a computer

◀ 182–183 Binary and bases

## AND gate

Gates use one or more input signals to produce an output signal, based on a simple rule. AND gates switch their output signal “on” (1) only when both input signals are “on” (1 and 1).

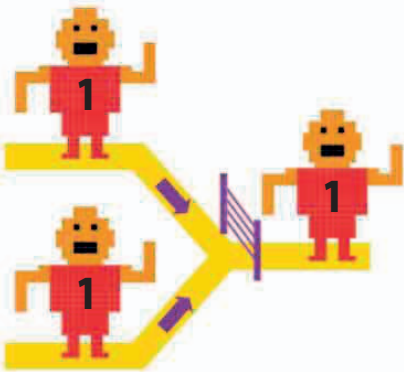

△ **Inputs 1 and 1 = output 1**  
Both input signals are “on”, so the AND gate produces an “on” output signal.

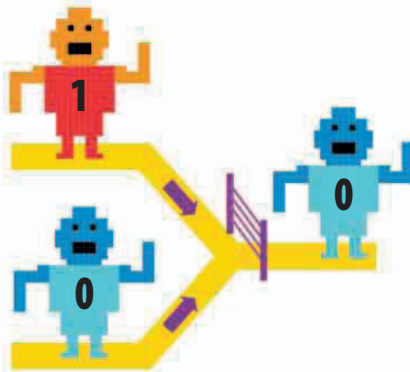

△ **Inputs 1 and 0 = output 0**  
If one input is “on” but the other is “off”, the output signal is “off”.

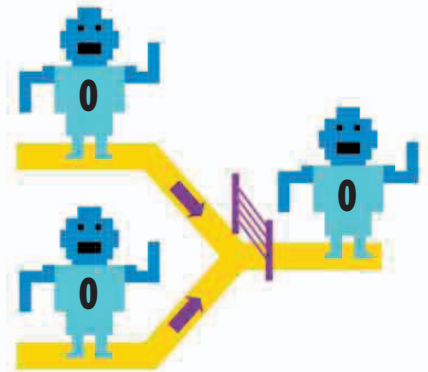

△ **Inputs 0 and 0 = output 0**  
An AND gate produces an “off” output signal if both input signals are “off”.

## NOT gate

These gates “flip” any input to its opposite. “On” input becomes “off” output, and “off” input turns to “on” output. NOT gates are also known as “inverters”.

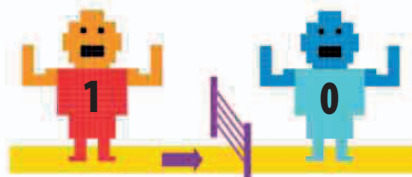

△ **Input 1 = output 0**  
The NOT gate flips an “on” input to an “off” output, and vice versa.



## REAL WORLD

### George Boole (1815–64)

George Boole was an English mathematician whose work made logic gates possible. He worked out a system to solve logic problems. This kind of math, which deals in values that can only be true or false (positive or negative), is known as “Boolean logic” in his honor.

## OR gate

An OR gate produces an “on” output when either one of the inputs is “on”, or when both are “on”.

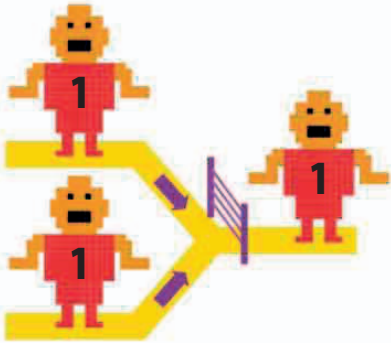

△ **Inputs 1 and 1 = output 1**

Two “on” inputs produce an “on” output.

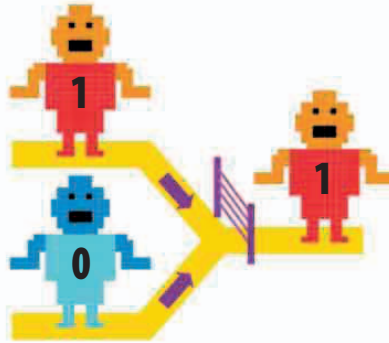

△ **Inputs 1 and 0 = output 1**

One “on” and one “off” input still produce an “on” output.

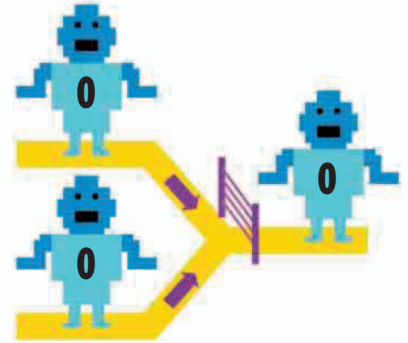

△ **Inputs 0 and 0 = output 0**

Only two “off” inputs produce an “off” output from an OR gate.

## EXCLUSIVE OR gate

This type of gate only gives an “on” output when one input is “on” and the other is “off”. Two “on” or two “off” inputs will produce an “off” output. Gates like this are also known as “XOR” gates.

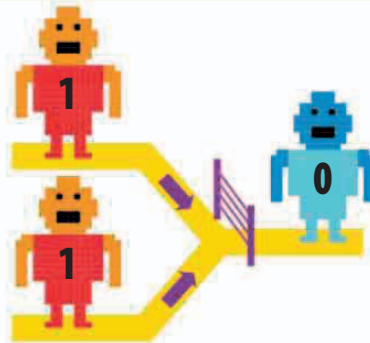

△ **Inputs 1 and 1 = output 0**

Two “on” inputs produce an “off” output.

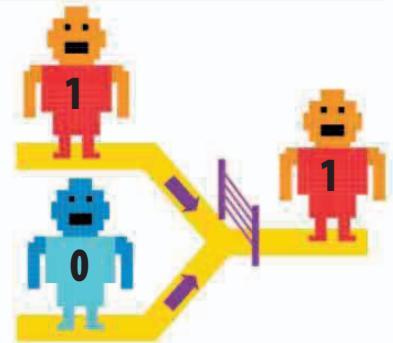

△ **Inputs 1 and 0 = output 1**

The output is only “on” when the inputs are different.



### EXPERT TIPS

## Building computer circuits

By combining these four basic logic gates, you can create circuits to perform a whole range of advanced functions. For example, by linking an AND gate to an XOR gate, you create a circuit that can add two binary digits (bits) together. By linking two OR gates

with two NOT gates in a loop, you can create a circuit that will store a bit of data (a single 1 or 0). Even the most powerful computers are based on billions of tiny logic circuits.

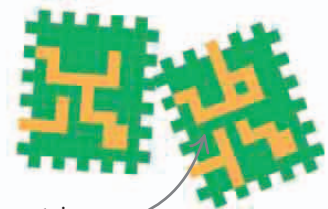

Computer chips contain many logic circuits

# Processors and memory

Inside a computer are many types of electronic chips. Most importantly, the processor chip runs programs and memory chips store data for instant access.

## SEE ALSO

◀ **180–181** Inside a computer

◀ **186–187** Logic gates

## The processor

Processors are a collection of very small and complex circuits, printed on a glasslike material called silicon. Small switches called transistors are combined to form simple logic gates, which are further combined to form complex circuits. These circuits run all the programs on your computer.

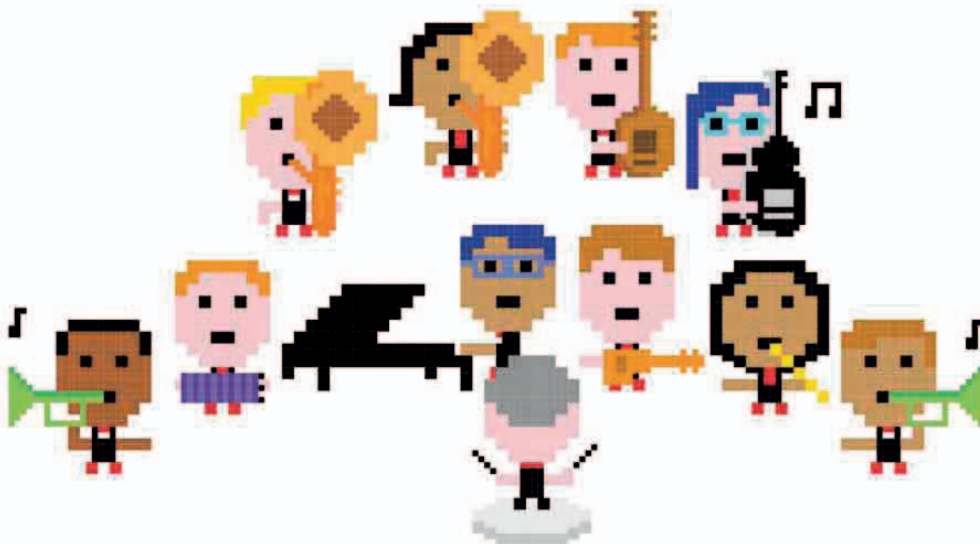

### ◀ Circuits in a processor

The circuits are kept synchronized by a clock pulse, just like an orchestra is kept in time by a conductor.

## Machine code

Processors only understand a set of program instructions called “machine code”. These simple instructions for operations like adding, subtracting, and storing data are combined to create complex programs.

### ▷ Understanding machine code

Machine code is just numbers, so coders use programming languages like Python that get converted into machine code.

Save to memory

Call another piece of code

Compare two values

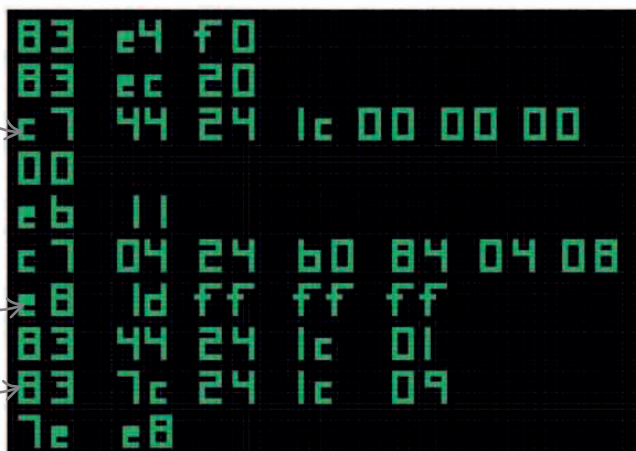

## Memory

Like processors, memory chips are printed on silicon. A few logic gates are combined to create a “latch circuit”. Each latch stores one bit (the smallest unit of data with a binary value of either 1 or 0), and many latches are combined to create megabytes and gigabytes of storage.

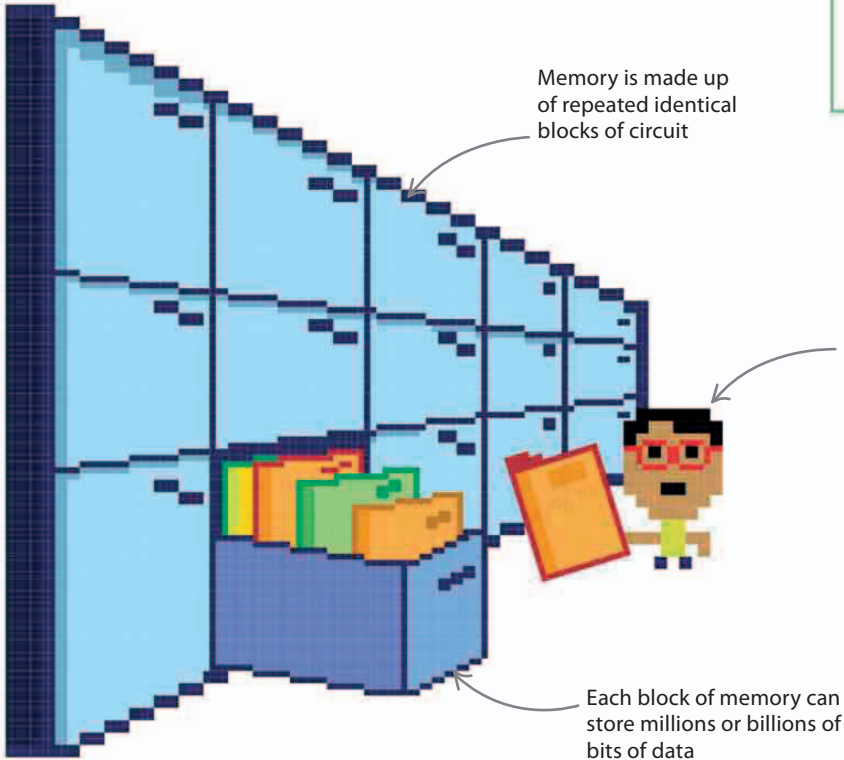

LINGO

### RAM

Memory is often referred to as RAM (“Random Access Memory”), meaning any part of it can be accessed directly. Early types of storage could only access data in order from start to end, which was much slower.

#### ◀ Programs and data

Programs constantly read, write, and update the data stored in the memory.



REMEMBER

## Processing information

The processor and memory, when combined with input and output devices, give you everything you need for a computer. In a game program, for example, the user inputs position data by clicking the mouse, the processor does the calculations, reads and writes memory, and then produces output in the form of making the character jump on the screen.

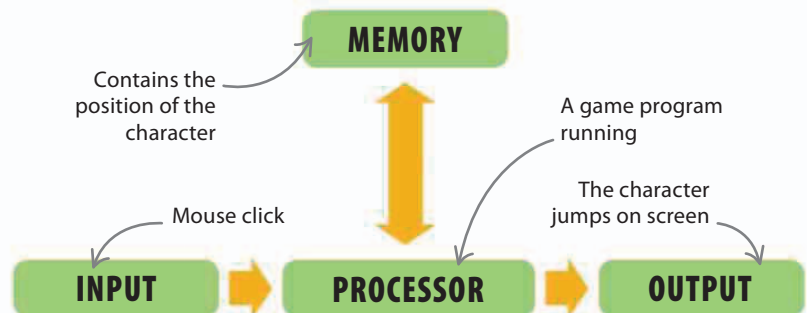

# Essential programs

There are a few programs that every computer needs in order to work. Some of the most important programs are operating systems, compilers, and interpreters.

## SEE ALSO

◀ **180–181** Inside a computer

◀ **182–183** Binary and bases

◀ **188–189** Processors and memory

## Operating system

The operating system (OS) is the manager of the computer's resources. It controls which programs are allowed to run, how long they run for, and which parts of the computer they use while running. The OS also provides interfaces, such as file browsers, to let a user interact with the computer. Common operating systems include Microsoft Windows and Mac OS X.

The operating system is like an octopus, with tentacles connecting to all parts of the computer

The operating system manages the processor's time

### ▷ How it works

The processor's time is divided up into slices. A program will be given a slice. If it can't finish in that time, it is paused and the next program runs.

This program has run and is now waiting for its next slice of processor time

Each program has its own space in the computer's memory

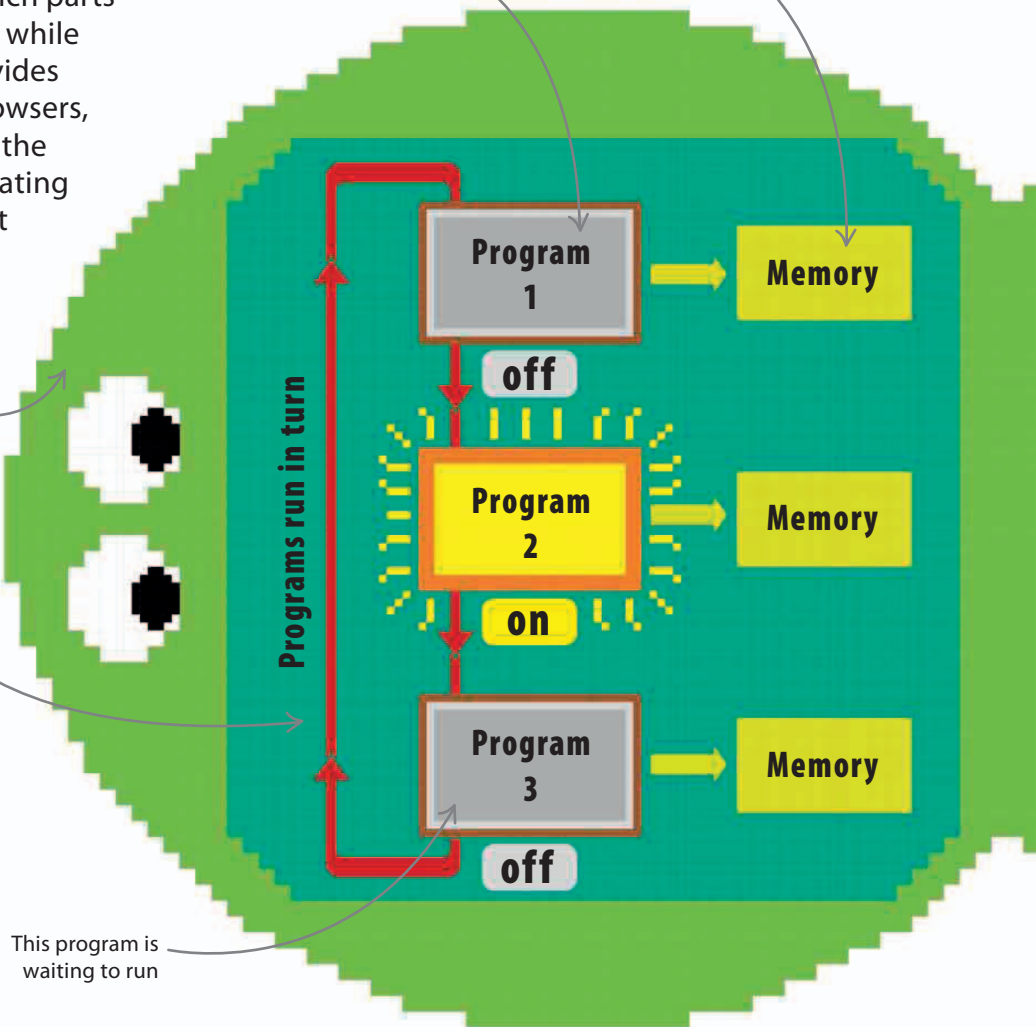

This program is waiting to run



# Compilers and interpreters

The languages you write programs with, such as Python, are known as “high-level languages”. Computer processors don’t understand these languages, so compilers and interpreters are used to translate them into a low-level language (known as “machine code”) that a computer does understand.

## Compiler

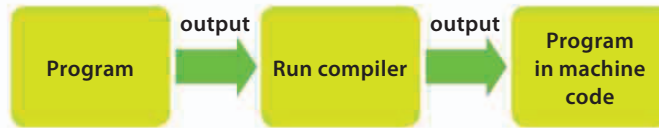

△ **Compiler**  
Compilers produce translated machine code that can be saved and run later.

## Interpreter

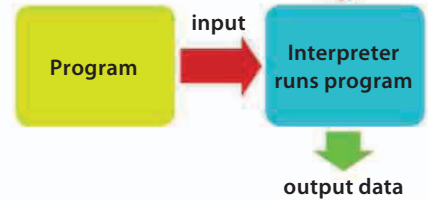

▷ **Interpreter**  
Interpreters translate the code and execute the program at the same time.

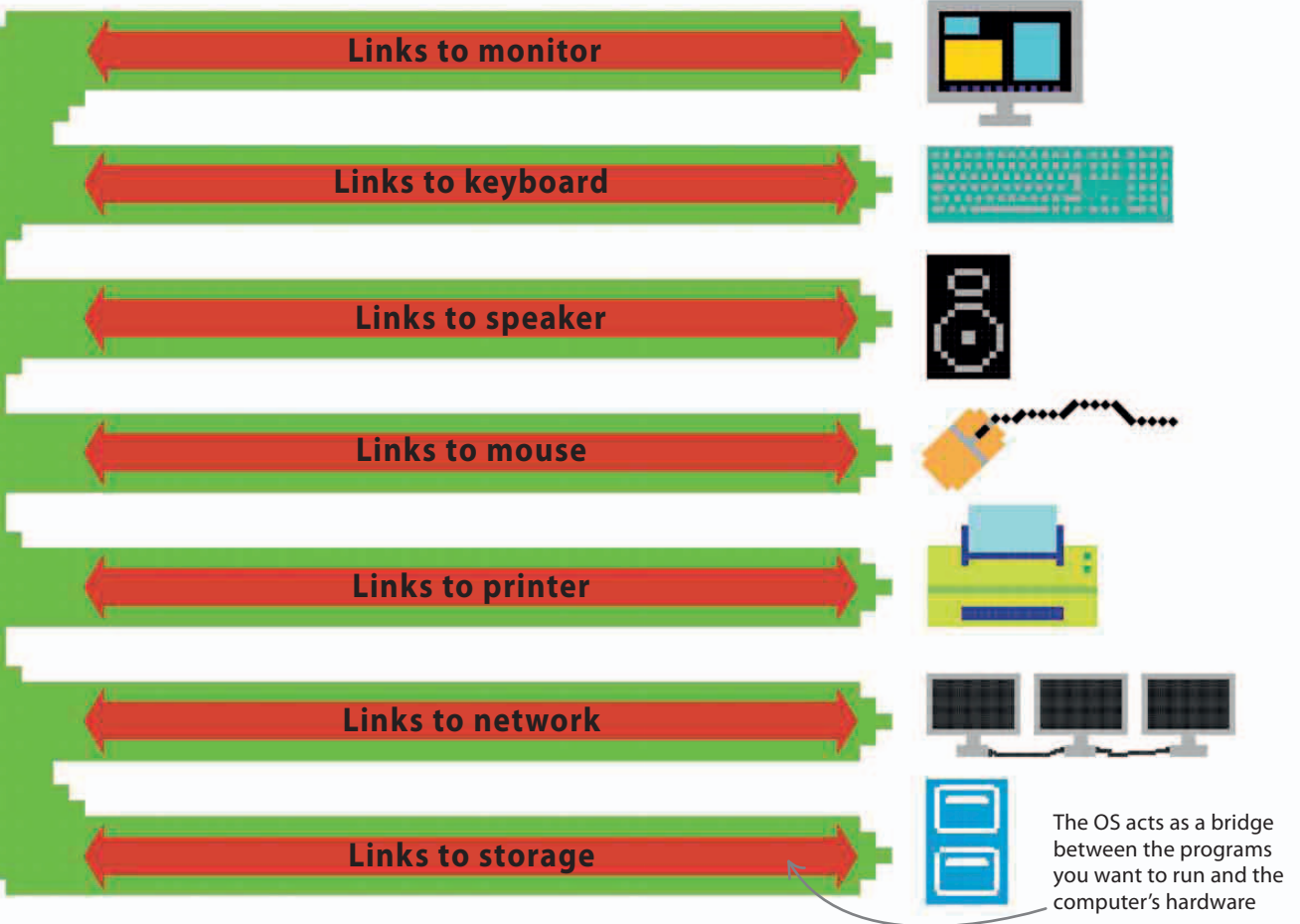

# Storing data in files

A computer's memory doesn't just store numbers and characters. Many more types of data can be stored, including music, pictures, and videos. But how is this data stored? And how can it be found again?

## SEE ALSO

◀ **182–183** Binary and bases

◀ **188–189** Processors and memory

◀ **190–191** Essential programs

## How is data stored?

When data is saved to be used later, it is put into a file. This file can be given a name that will make it easy to find again. Files can be stored on a hard-drive, memory stick, or even online—so data is safe even when a computer is switched off.

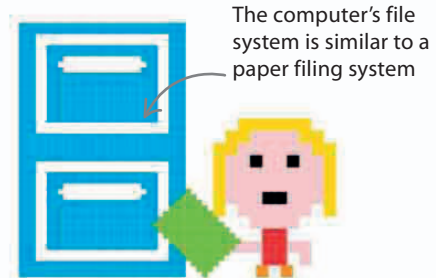

The computer's file system is similar to a paper filing system

## EXPERT TIPS

### File sizes

Files are essentially collections of data in the form of binary digits (bits). File sizes are measured in the following units:

#### Bytes (B)

1 B = 8 bits (for example, 10011001)

#### Kilobytes (KB)

1 KB = 1,024 B

#### Megabytes (MB)

1 MB = 1,024 KB = 1,048,576 B

#### Gigabytes (GB)

1 GB = 1,024 MB = 1,073,741,824 B

#### Terabytes (TB)

1 TB = 1,024 GB = 1,099,511,627,776 B

### File information

There is more to a file than just its contents. File properties tell the system everything it needs to know about a file.

Right-click on a file to see properties such as file type, location, and size

FILE PROPERTIES	
The file name should be memorable	<b>name</b> groove
What type of file it is, typically in three characters	<b>file type extension</b> mp3
The program that can handle the file's data	<b>opens with</b> Music Player
The location of the file on the computer	<b>full directory path</b> /Users/Jack/Music
The file size (see the box on the left)	<b>size</b> 50 MB

## Directories

It's easier to find files on a computer system if they are well organized. To help with this, files can be grouped together in "directories", also known as "folders". It's often useful for directories to contain other directories in the form of a directory tree.

### ▽ Directory tree

When directories are placed inside other directories, it creates a structure that resembles an upside-down tree, and just like a tree it has roots and branches (confusingly called "paths").



### EXPERT TIPS

## Managing files

A file manager program helps find files and directories. Each operating system has a different one:

**Windows:** Use Windows Explorer to look around the directory tree.

**Apple:** Use Finder to look around the directory tree.

**Ubuntu:** Use Nautilus to look around the directory tree.

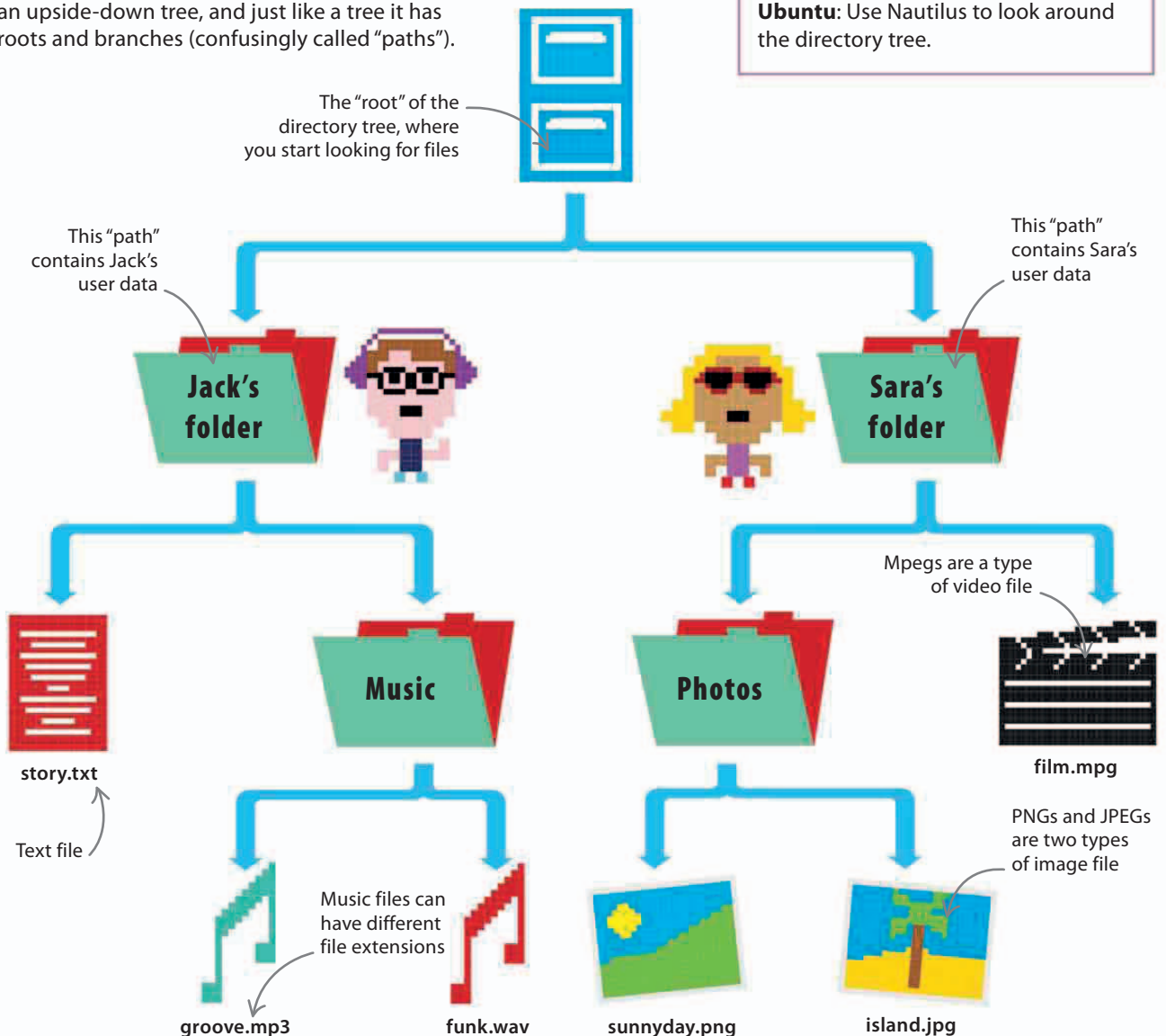

# The Internet

The Internet is a network of computers all across the world. With so many computers, clever systems are needed to make sure information goes to the right place.

## IP addresses

Every computer or phone connected to the Internet has an address, much like a building. The addresses are called “Internet Protocol (IP) addresses” and each one is made up of a series of numbers.

### ▽ Sending information

Files travel between computers in small chunks called packets. Special computers called routers forward these packets to their destination.

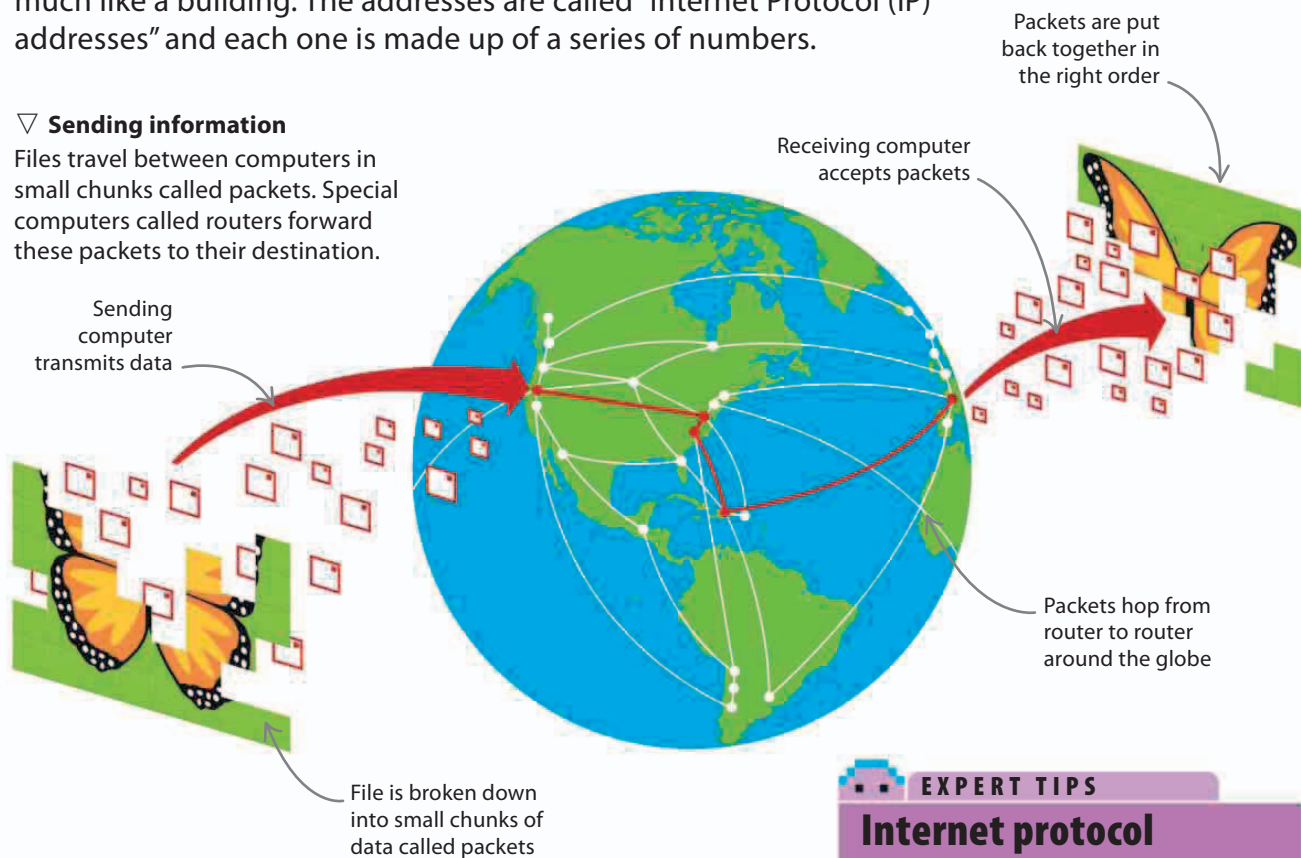

### ◁ Address information

Every packet of data is labeled with the destination and sender's IP addresses. Domain names like “dk.com” are translated into IP addresses.

### SEE ALSO

◀ 182–183 Binary and bases

◀ 192–193 Storing data in files

### EXPERT TIPS

## Internet protocol

A protocol is a list of rules. “Internet Protocols” are rules for how big packets can be and how they are structured. All Internet devices must follow these rules if they want to be able to communicate with each other.

## Moving data

Before packets can be sent between devices, they have to be translated into binary signals (ones and zeroes) that can travel over great distances. Every device on the Internet has a “network adapter” to perform this task. Different devices send data in different forms.



△ **Electrical signals**  
Copper wires carry ones and zeroes as electrical signals of different strengths.



△ **Light**  
Special glass fibres, called fibre optic cables, transmit data as pulses of light.



△ **Radio waves**  
Different types of radio waves can carry ones and zeroes without using wires.

## Ports

Just as you mail a letter to a specific person in an apartment building, you may want to send packets to a specific program on a device. Computers use numbers called “ports” as addresses for individual programs. Some common programs have ports specially reserved for them. For example, web browsers always receive packets through port number 80.

### ▽ Port numbers

The numbers used for ports range from 0 to 65535 and are divided into three types: well-known, registered, and private.

A device's IP address is like the street address of a building

**IP 165.193.128.72**

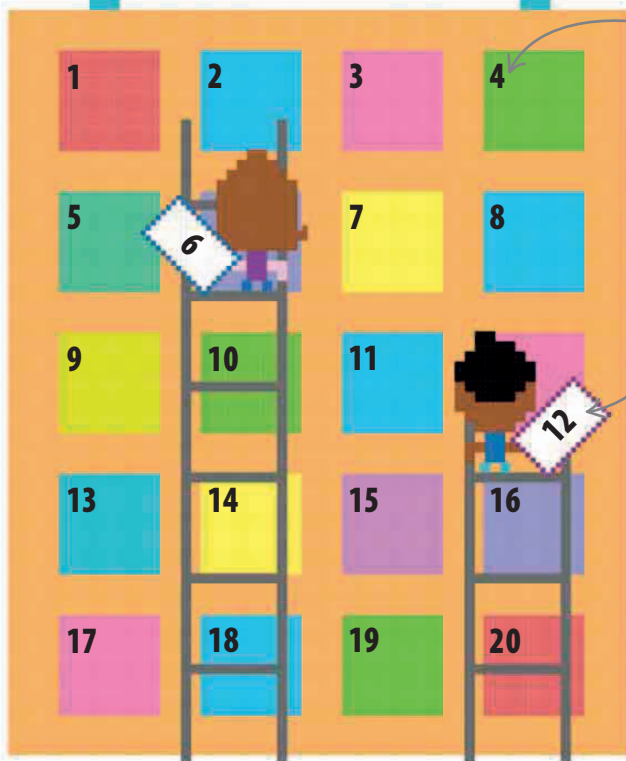

A port within a device is like an apartment in a building

Routers deliver packets like mailmen to the correct addresses

### EXPERT TIPS

#### Sockets

The combination of an IP address and a port is known as a “socket”. Sockets let programs send data directly to each other across the Internet, which is useful for things such as playing online games.





# Programming in the real world



# Computer languages

Thousands of different programming languages have been created. Which one you should use depends on a number of factors, such as the type of program being written and which kind of computer it will run on.

## Popular programming languages

Some languages have emerged as the most popular for creating certain types of program on certain types of computer. Here is how to run a simple “Hello World!” program in a few popular programming languages.

### SEE ALSO

Computer **204–205** ›  
games

Making **206–207** ›  
apps

```
#include <iostream>
int main()
{
    std::cout << "Hello World!" << std::endl;
}
```

#### △ C++

Based on C, but with extra features. Used in programs that need to be fast, such as console games.



```
#import <stdio.h>
int main(void)
{
    printf("Hello World!");
}
```



#### △ Objective-C

Based on C, with some extra features. It has become popular because of its use on Apple’s Mac and iOS devices.

```
class HelloWorldApp {
public static void main(String[] args) {
    System.out.println("Hello World!");
}
}
```

#### △ Java

A very versatile language that can run on most computers. It’s often used for coding on the Android operating system.



```
<?php
echo "Hello World!";
?>
```



#### △ PHP

Mostly used for creating interactive websites, PHP runs on the web servers that host websites.

```
#include <stdio.h>
main()
{
    printf("Hello World!");
}
```



#### △ C

One of the most popular languages of all time, C is often used for programming hardware.

```
alert('Hello World!');
```



#### △ JavaScript

Used to create programs that run on web browsers, such as simple games and email websites.



## Languages from the past

Many languages that were famous twenty or thirty years ago have fallen in popularity, despite still being used in some very important systems. These languages are often seen as difficult to code by modern standards.

### BASIC

Designed in 1964 at Dartmouth College, in the US, BASIC was very popular when home computers first became available.

### Fortran

Designed in 1954 at IBM, a technology firm, Fortran is mainly used for calculations on large computers. It is still being used in weather forecasting.

### COBOL

Designed in 1959 by a committee of experts, COBOL is still being used in many business and banking programs.



### REAL WORLD

## Millennium bug

Many programs in older languages like COBOL used two digits to represent a year (such as 99 for 1999). The “millennium bug” was predicted to cause problems in 2000 when these dates rolled over into the new millennium as 00.

Computers all over the world had to be updated to prevent the millennium bug

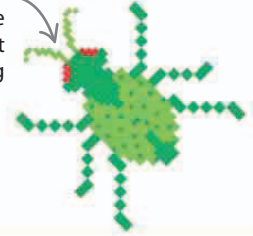

## Weird languages

Among the thousands of languages are a few that have been created for very specific and strange purposes.

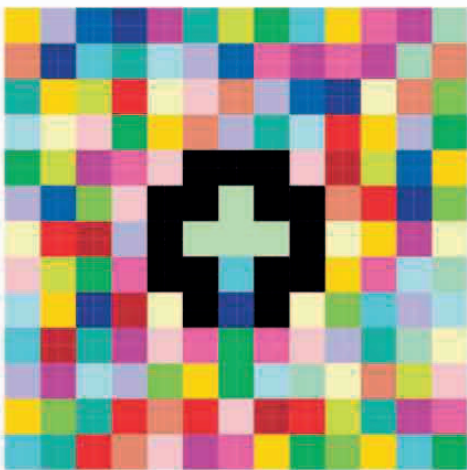

### △ Piet

Programs created in Piet code look like abstract art. The “Hello World!” program is shown above.

```
('&%:9]!~}z2Vxwv-,POqponI$Hjig%eB@>a=<M:9[p6ts1TS/
QlOj)L(I&%$""Z~AA@UZ=RvtT`R5P3m0LEDh,T*?(b& $#87[]fW
```

### △ Malbolge

The Malbolge language was designed to be impossible to program. The first working code did not emerge until two years after its release, and was written by another program.



### △ Chef

A program written in Chef is meant to resemble a cooking recipe. However, in practice, the programs rarely produce useful cooking instructions.

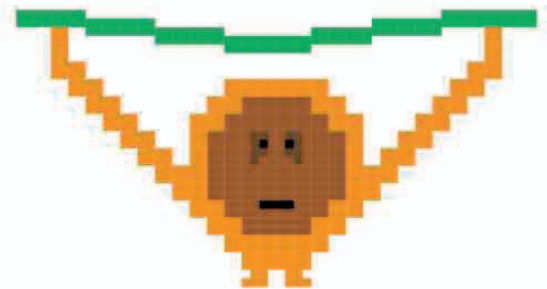

### △ Ook!

Designed to be used by orangutans, Ook! has only three elements: “Ook”, “Ook!”, and “Ook?” These can be combined to create six commands, such as “Ook! Ook” and “Ook? Ook!”

# Coding stars

Computing is driven forward every day by millions of programmers all around the world, but every now and then someone special comes along and takes a massive leap. Here are a few of the most famous coders.

## SEE ALSO

◀ 18-19 Becoming a coder

Computer 204-205 ▶  
games

## Ada Lovelace

**Nationality:** British

**Dates:** 1815-52

**Famous for:** Ada Lovelace is considered to be the first computer programmer. In 1843, she published the first program for Charles Babbage's Analytical Engine (a proposed early computer). She also suggested methods for representing characters as numbers.



## Alan Turing

**Nationality:** British

**Dates:** 1912-54

**Famous for:** Mathematician Alan Turing is known as the father of computer science. He's also famous for his ground-breaking work cracking secret German codes during World War II for the British.



## Grace Hopper

**Nationality:** American

**Dates:** 1906-92

**Famous for:** Grace Hopper created the first programming language compiler (which transforms human readable programs into machine code). As well as being a computer scientist she was a Rear Admiral in the US Navy!

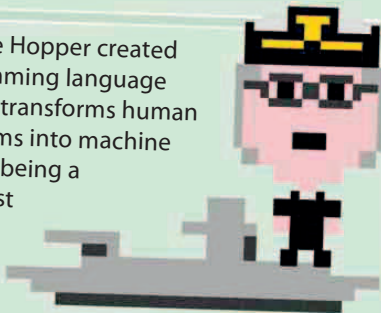

## Bill Gates and Paul Allen

**Nationality:** American

**Dates:** Gates 1955-present, Allen 1953-present

**Famous for:** Bill Gates and Paul Allen founded Microsoft together in the 1970s. They invented some of the most popular programs ever, such as Microsoft Windows and Office.



## Gunpei Yokoi and Shigeru Miyamoto

**Nationality:** Japanese

**Dates:** Yokoi 1941–97, Miyamoto 1952–present

**Famous for:** Yokoi and Miyamoto worked for Nintendo, the gaming company. Yokoi invented the Game Boy, while Miyamoto made successful games such as Super Mario.

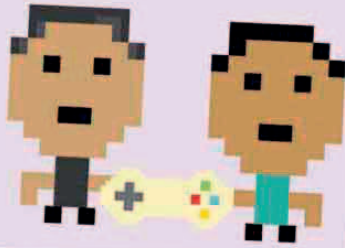

## Tim Berners-Lee

**Nationality:** British

**Dates:** 1955–present

**Famous for:** While working at CERN (a famous scientific research center in Switzerland), Tim Berners-Lee invented the World Wide Web, and made it free for everyone. He was knighted by Queen Elizabeth II in 2004.



## Larry Page and Sergei Brin

**Nationality:** American

**Dates:** Both 1973–present

**Famous for:** In 1996, Page and Brin began work on what would become the Google search engine. Their effective search method revolutionized the Internet.

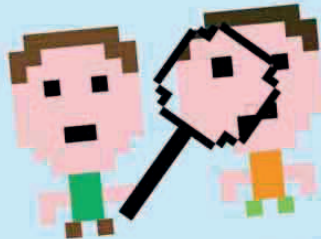

## Mark Zuckerberg

**Nationality:** American

**Dates:** 1984–present

**Famous for:** Zuckerberg launched Facebook from his college room in 2004. Facebook has since become a billion-dollar company, and made Zuckerberg one of the wealthiest people alive.



## Open Source Movement

**Nationality:** All

**Dates:** Late 1970s–present

**Famous for:** The open source movement is a collection of programmers around the world who believe software should be free and available to all. The movement has been responsible for many significant pieces of software, such as the GNU/Linux operating system and Wikipedia, the online encyclopedia.

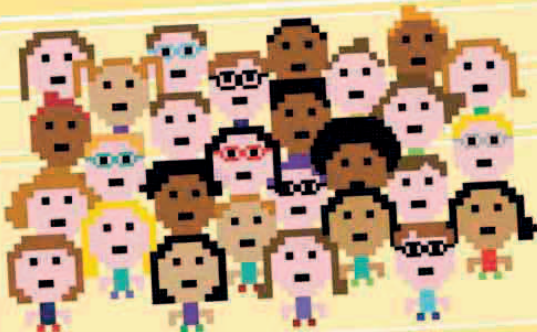

# Busy programs

Computers and programs have become an invisible part of daily life. Every day, people benefit from very complex computer programs that have been written to solve incredibly tough problems.

## SEE ALSO

◀ **180–181** Inside a computer

◀ **192–193** Storing data in files

## Compressing files

Almost every type of file that is sent over the Internet is compressed (squeezed) in some way. When a file is compressed, data that isn't needed is identified and thrown away, leaving only the useful information.



## REAL WORLD

### Music files

Without music compression programs, you could only fit a few songs on your music player. By compressing audio files, the average smartphone can now hold thousands of songs.

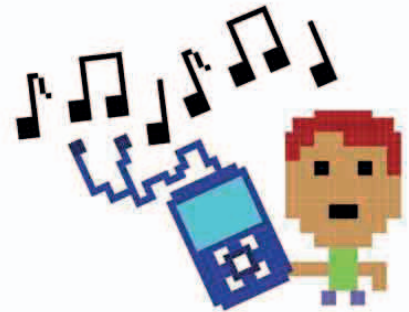

## Secret codes

When you log in to a website, buy something, or send a message across the Internet, smart programs scramble your secret data so that anyone who intercepts it won't be able to understand it. Global banking systems rely on these advanced programs capable of hiding secret information.

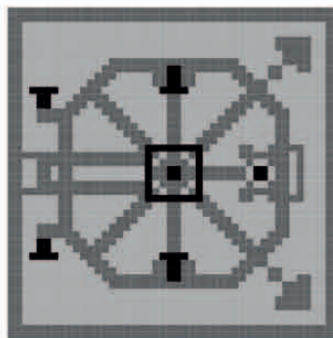

### ◀ **Cryptography**

Cryptography is the study of codes. Complex mathematical codes scramble and unscramble personal data to keep it safe from thieves.

## Artificial Intelligence

Intelligent programs do more than just make computer games fun. Artificial Intelligence (AI) is being used to provide better healthcare, as well as helping robots operate in places too dangerous for humans to go, such as war zones and areas destroyed by natural disasters.



### △ Medicine

Systems are able to analyze a huge database of medical information and combine it with details from the patient to suggest a diagnosis.

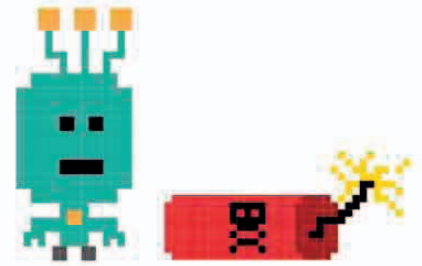

### △ Bomb disposal

Many soldiers' lives can be saved by using an intelligent robot to safely dispose of a bomb in an area that has been cleared of people.

## Supercomputers

Supercomputers—used by high-tech organizations such as NASA—combine the power of thousands of computer processors that share data and communicate quickly. The result is a computer that can perform millions of calculations per second.

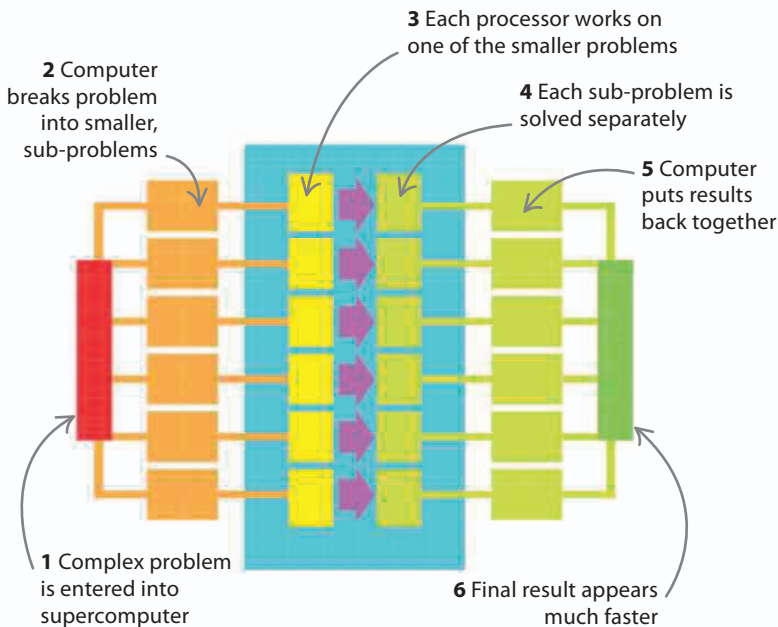

### △ How it works

Problems are broken into smaller problems that are all worked on separately at the same time by different processors. The results are then combined together to give the answer.



## REAL WORLD

### Weather forecast

Weather patterns are very unpredictable. Supercomputers crunch the huge amounts of data needed to accurately predict what will happen. Each processor in the supercomputer calculates the weather for a small part of the map. All the results are then combined to produce the whole forecast.



# Computer games

What does it take to make a modern video game? All computer games are a different mix of the same ingredients. Great games are usually made by teams of software developers—not just programmers.

## Who makes computer games?

Even simple games on your mobile phone might be made by large teams of people. For a game to be popular and successful, attention to detail needs to be given to every area during its development, which involves many people with lots of different skills.



### △ Coder

Programmers write the code that will make the game work, but they can only do this with input from the rest of the team.



### ◁ Level designer

The architects of the game's virtual world, level designers create settings and levels that are fun to play.



### △ Graphic designer

All of the levels and characters need to look good. The graphic designers define the structure and appearance of everything in the game.



### △ Scriptwriter

Modern games have interesting plots just like great books and films. Scriptwriters develop all the characters and stories for the game.

### ▷ Tester

Playing games all day may seem like a great job, but testers often play the same level over and over again to check for bugs.



### ◁ Sound designer

Just like a good movie, a great game needs to have quality music and sound effects to set the mood.

## SEE ALSO

◀ 200–201 Coding stars

Making 206–207 › apps



## LINGO

### Consoles

A console is a special type of computer that is well suited to running games. Consoles, such as the PS4 and Xbox One, often have advanced graphics and sound processors capable of running many things at once, making more realistic games possible.

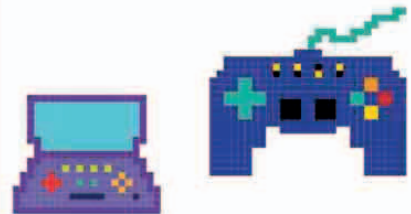

## Game ingredients

The most common ingredients in games are often combined into a “game engine”. Engines provide an easy-to-use base so that new games can be developed quickly.

### ▷ Story and game logic

All games must have a good story and some sort of goal to aim for, such as saving the princess. Well-designed game logic keeps players interested.

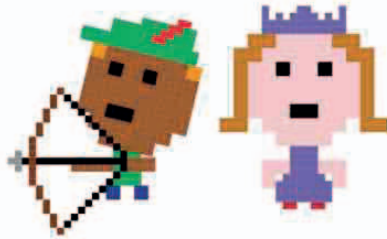

### ◁ Game physics

In a virtual world, the rules of the real world, such as gravity and collisions, must be re-created to make the game more believable.



### ▷ Controls

Familiar controls that make sense to the player help make a great game. Good control design makes the player forget that they are using a controller.

### ▷ Sound

All of the words spoken in the game must be recorded, as well as the background music and the sound effects that change throughout the game.

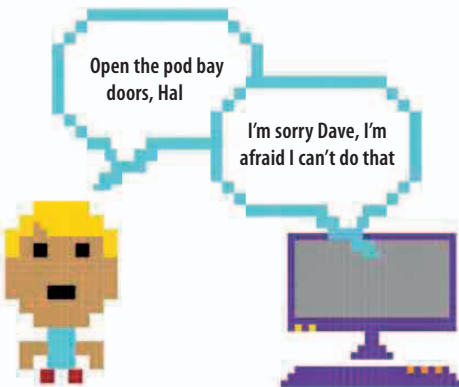
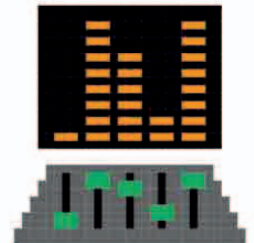

### △ Artificial intelligence

Human players often play alongside or against computer-controlled players. Artificial intelligence programming allows these characters to respond realistically.

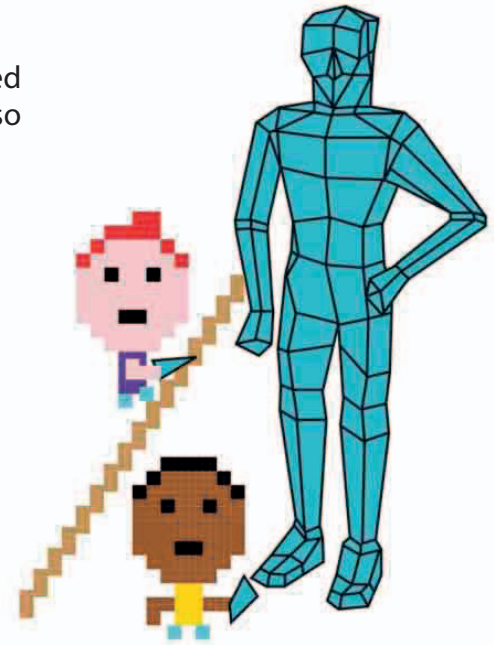

### △ Graphics

As games become more realistic their graphics must become more complex. Body movements, smoke, and water are particularly hard to get right.

## REAL WORLD

### Serious games

Games are being used for more than just fun. Pilots, surgeons, and soldiers are just some of the professionals who use games at work for training purposes. Some businesses even use strategy games to improve their employees' planning skills.

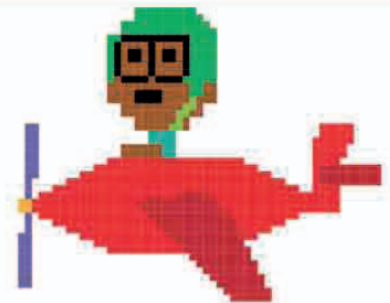

# Making apps

Mobile phones have opened up a world of possibilities for coders. With a computer in everyone's pocket, mobile apps can use new inputs, such as location-finding and motion-sensing, to give users a better experience.

## SEE ALSO

◀ **190–191** Essential programs

◀ **198–199** Computer languages

◀ **204–205** Computer games

## What is an app?

“App” (short for “application”) is a word that describes programs that run on mobile devices, including smartphones, tablets, and even wearable technology such as watches. There are many different categories of apps that do different things.



### ◀ Games

All sorts of games are available on mobile devices, from simple puzzle games to fast-paced action adventures.



### △ Weather

Mobile apps use your location to provide accurate weather forecasts, and also allow you to check the weather around the world.

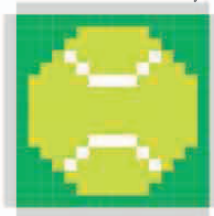

### ◀ Sport

People use apps to track their fitness when running or cycling, and can also keep up to date on the latest sports scores while on the go.



### ◀ Social network

Social apps can allow people to connect with friends, whether they are nearby or far away, to share thoughts, pictures, music, and videos.

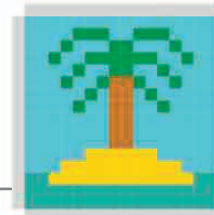

### △ Travel

Travel apps use your location combined with other users' reviews to provide recommendations for restaurants, hotels, and activities.

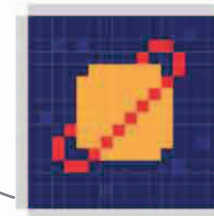

### △ Education

Educational apps are great for learning. Young children can learn to count and spell, and older people can learn a new language.

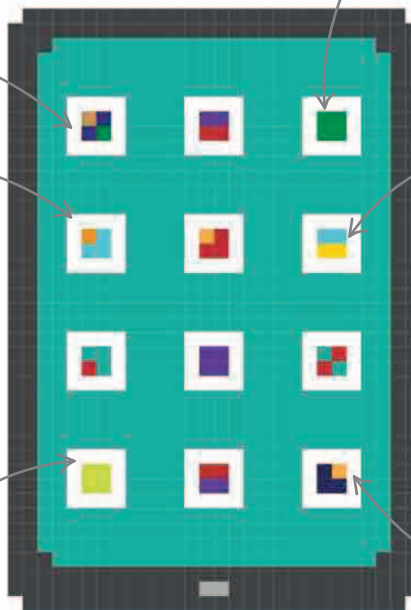



## How to build an app

There are many questions to answer before building an app. What will it do? What devices will it run on? How will the user interact with it? Once these questions are answered, building an app is a step-by-step process.

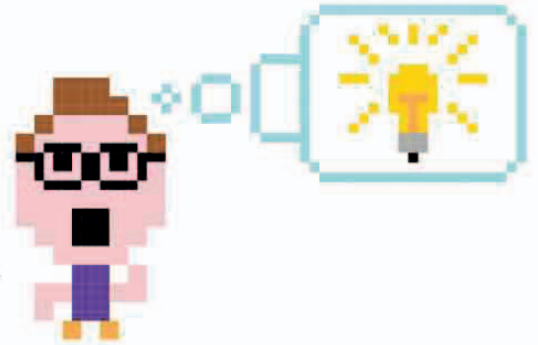

### 1 Have an idea

Any idea for a new app must be well suited to mobile devices. It might be a completely new idea, or it could just be an improvement on an already existing idea to make a better version.

Mac

Android

Windows

### 2 Which operating system?

Will the app target a certain type of mobile device? Coders can often use tools that let them write their application once and then adapt it for different operating systems.

### 3 Learn to make apps

Whichever platform the app will run on, a coder needs to learn the language and other skills needed to build a good app. Online tutorials and local coding clubs can help.

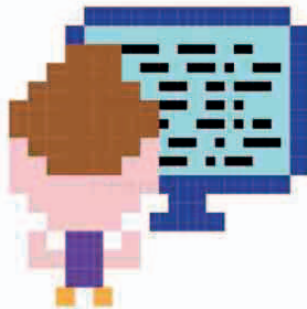
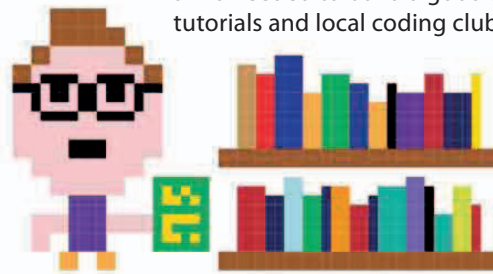

### 4 Create the program

Good apps take time to make. A basic version might be working in weeks, but for an app to be really successful, it will need to be developed for a few months before its release.



### 5 Test it

Users will quickly get rid of an app if it contains bugs. Putting in tests as part of the code, and getting friends and family to try out the app can help clean up any errors before the app is released.

# Programming for the Internet

Websites are built using coding languages that work just like Python. One of the most important of these is JavaScript, which makes websites interactive.

## How a web page works

Most web pages are built using several different languages. An email website, for instance, is made with CSS, HTML, and JavaScript. The JavaScript code makes the site respond instantly to mouse clicks without having to reload the page.

### SEE ALSO

◀ 198–199 Computer languages

Using 210–211 ▶  
JavaScript

### ◀ CSS

The language CSS (Cascading Style Sheets) controls the colors, fonts, and layout of the page.

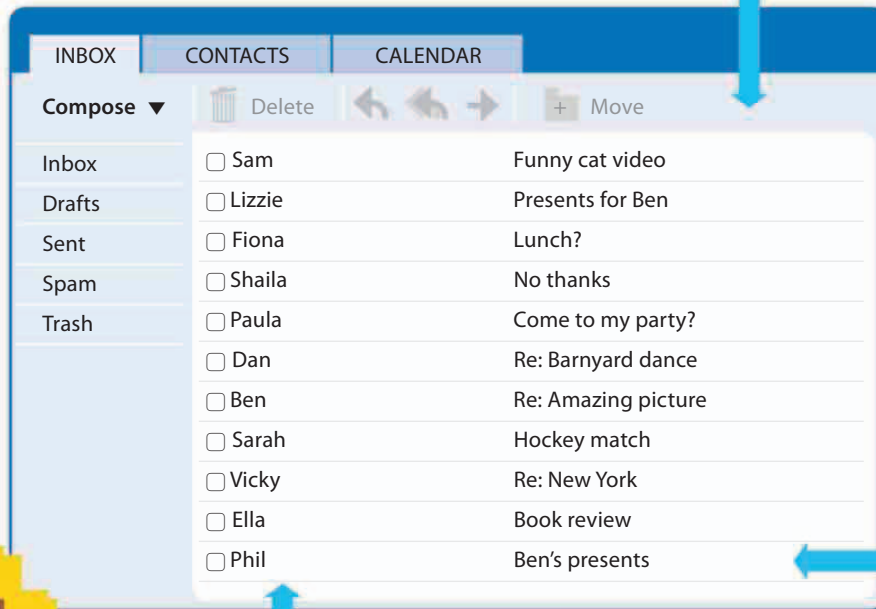
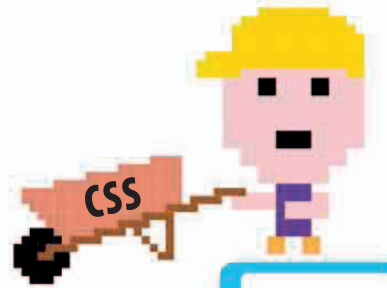

### ◀ HTML

HTML (HyperText Markup Language) builds the basic structure of the page, with different sections that contain text or images.

### ▶ JavaScript

JavaScript controls how the page changes when you use it. Click on an email, for instance, and JavaScript makes a message open up.

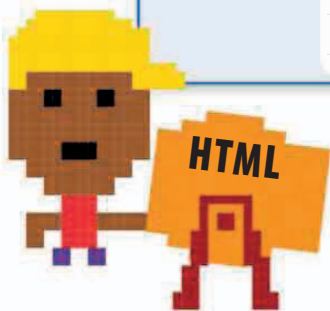

## HTML

When you open a website, your Internet browser downloads an HTML file and runs the code to turn it into a web page. To see how it works, type the code here into an IDLE code window (see pp.92–93) and save it as a file with the ending “.html”. Double click the file and it will launch a browser window saying “Hello World!”

```
<html>
<head>
  <title>The Hello World Window</title>
</head>
<body>
  <h1>Hello World in HTML</h1>
  <p>Hello World!</p>
</body>
</html>
```

Blocks of text are surrounded by “tags”, a very common feature in HTML code. This tag gives the window a title

The “<p>” and “</p>” tags surround ordinary paragraphs

This tag shows where the HTML code ends

## Trying JavaScript

It’s easy to experiment with JavaScript because all modern web browsers can understand it. JavaScript code is usually placed within HTML code, so the example below uses two coding languages at once. The JavaScript section is surrounded by “<script>” tags.

### 1 Write some JavaScript

Open a new IDLE code window and type out the code below. Check the code very carefully. If there are any errors, you’ll just see a blank page.

```
<script>
alert(“Hello World!”);
</script>
```

The “<script>” tag introduces JavaScript code

The “alert” command will make an alert box pop up

### 2 Save your file

Save the file and enter a filename such as “test.html” so the code is saved as an HTML file and not a Python file. Then double click the file to test it.

test.html

Don’t forget to give your filename an “.html” ending

## EXPERT TIPS

### Games in JavaScript

JavaScript is so good at creating interactive features that it can be used to make games—from simple puzzles to fast-paced racing games. These will work in any modern web browser, so there’s no need to install the game first. JavaScript is also used to create web apps such as webmail or interactive calendars.

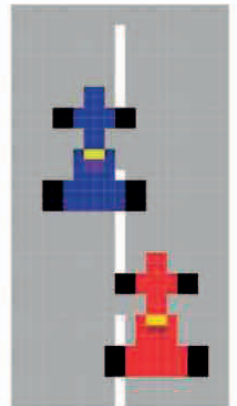

### 3 Pop-up appears

The browser will open and an interactive alert box will pop up with the greeting “Hello World!” Click “OK” to dismiss the box.

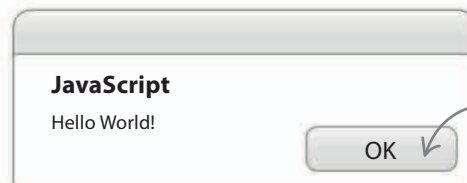

JavaScript creates interactive features such as buttons

# Using JavaScript

JavaScript is great for creating mini programs that run inside HTML, bringing websites to life and allowing users to interact with them. Although it works like Python, JavaScript code is more concise and trickier to learn.

## SEE ALSO

◀ **162–163** Reacting to events

◀ **122–123** Loops in Python

◀ **208–209** Programming for the Internet

## Getting input

As with Python, you can use JavaScript to ask the user for information. JavaScript can do this with a pop-up box. The following program prompts the user to enter their name and responds with a greeting.

### 1 Use a prompt

This short script stores the user's name in a variable. Type the code into the IDLE code window and remember to save it with a ".html" filename.

```
<script>
var name = prompt("Please enter your name");
var greeting = "Hello " + name + "!";
document.write(greeting);
</script>
```

This line creates a pop-up box and stores the text the user types into it

The text in quotes appears in the box

JavaScript lines always end with a semicolon

The "</script>" tag shows where the JavaScript ends

This line displays the greeting

### 2 Question appears

Double-click the HTML file to launch a browser window. Enter your name in the box and click "OK" to see the greeting.

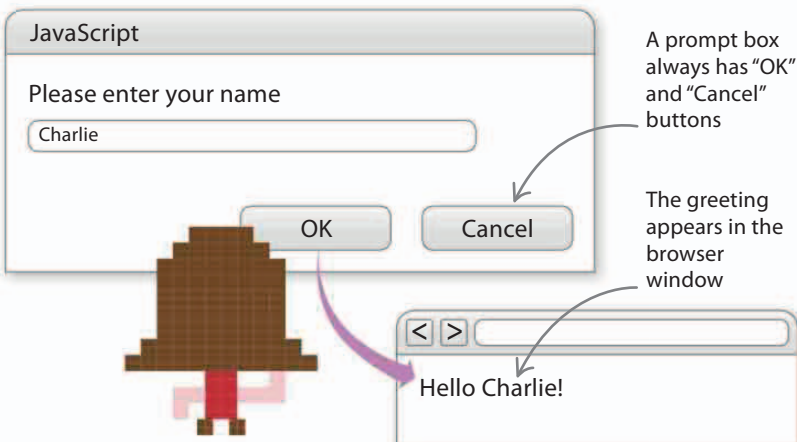

## EXPERT TIPS

### Type carefully

When working with JavaScript, be careful to check that you've typed out the code correctly. If there's an error, the browser will simply ignore the whole block of JavaScript and will create a blank window, without any error message saying what went wrong. If that happens, check the code again carefully.



## Events

An event is any action that a program can detect, such as a mouse click or a keystroke. The section of code that reacts to an event is called an “event handler”. Event handlers are used a lot in JavaScript and can trigger many different functions, making web pages fun and interactive.

### 1 Type the code

In this example, an event (clicking a button) triggers a simple function (a tongue-twister appears). Type the code in an IDLE code window and save the file with a “.html” ending.

```
<button onclick="tonguetwist()">Say this!</button>
<script>
  function tonguetwist()
  {
    document.write("She sells seashells");
  }
</script>
```

Annotations:

- Name of the function (points to `tonguetwist()`)
- HTML code links the function to a button (points to `onclick="tonguetwist()"`)
- Curly brackets surround a block of code—they work in a similar way to indents in Python (points to the curly braces around the function body)
- JavaScript code defines the function (points to the function body)

### 2 Run the program

Double-click the file to launch the program in a browser window.



## Loops in JavaScript

A loop is a section of code that repeats. Using loops is much quicker and easier than typing out the same line of code over and over again.

### 1 Loop code

Like Python, JavaScript uses “for” to set up a loop. The repeated lines of code are enclosed in curly brackets. This loop creates a simple counter that increases by one each time it repeats.

```
<script>
for (var x=0; x<6; x++)
{
  document.write("Loop count: "+x+"<br>");
}
</script>
```

Annotations:

- The “<script>” tag introduces the JavaScript code (points to `<script>`)
- This line creates a counter called “x” with a starting value of 0, rising by 1 in each repeat (points to `var x=0; x<6; x++`)
- This line tells the computer to write the text “Loop count:” followed by counter number (points to `document.write("Loop count: "+x+"<br>");`)

### 2 Loop output

Save the code as a “.html” file and run it. The loop keeps repeating as long as “x” is less than 6 (“x<6” in the code). To increase the number of repeats, use a higher number after the “<” symbol.

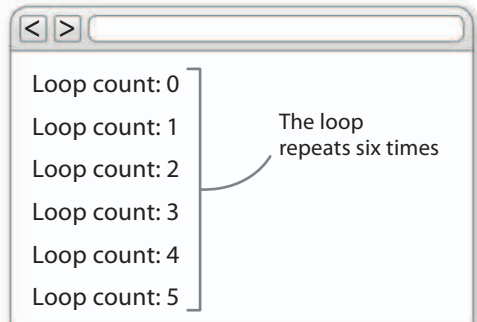

# Bad programs

Not all programs are fun games or useful apps. Some programs are designed to steal your data or damage your computer. They will often seem harmless, and you might not realize that you have been a victim.

## Malware

Programs that do things without your knowledge or permission are known as “malware”. Unauthorized access to a computer is a crime, but there are many different types of programs that still try to sneak on to your computer.

### ▷ Worm

A worm is a type of malware that crawls around a network from computer to computer. Worms can clog up networks, slowing them down—the first worm brought the Internet to a virtual standstill in 1988.

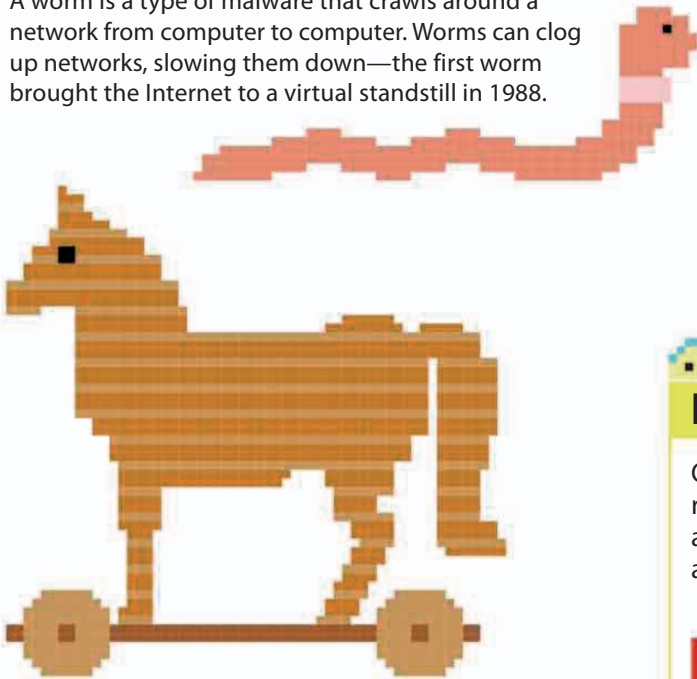

### △ Trojan

Malware that pretends to be a harmless program is known as a “trojan”. The word comes from a ruse used in the Trojan War: the Greeks gave the Trojans a giant wooden horse, with soldiers hidden inside. By breaching the Trojan defenses without detection, they won the war.

### SEE ALSO

◀ 194–195 The Internet

◀ 202–203 Busy programs

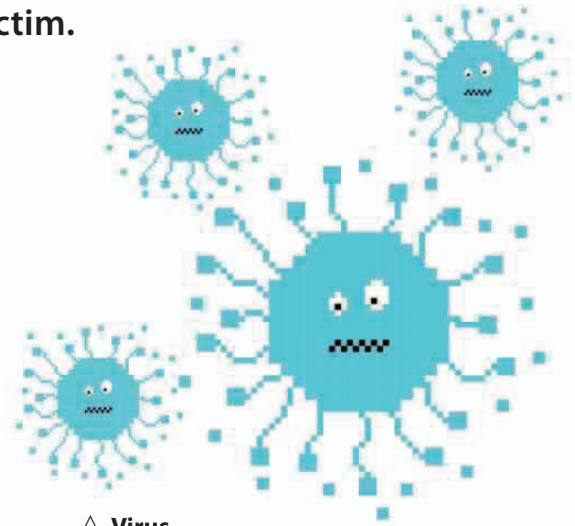

### △ Virus

Just like a virus in the human body, this malware copies itself over and over again. They are usually spread through emails, USB sticks, or other methods of transferring files between computers.

## REAL WORLD

### Famous worm

On May 5, 2000, Internet users in the Philippines received emails with the subject “ILOVEYOU”. An attachment appeared to be a love letter, but was actually a piece of malware that corrupted files.



### ◁ ILOVEYOU

This worm quickly spread to computers around the world. It is estimated to have cost more than \$20 billion to fix the damage it caused.

## What malware does

Viruses, worms, and trojans are all types of malware that are created to get into your machine, but what do they do once they have infected their target? They might delete or corrupt files, steal passwords, or seek to control your machine for some larger purpose as part of an organized “zombie botnet”.

### ▷ **Zombie botnets**

Botnets are collections of infected computers that can be used to send spam emails, or flood a target website with traffic to bring it crashing down.

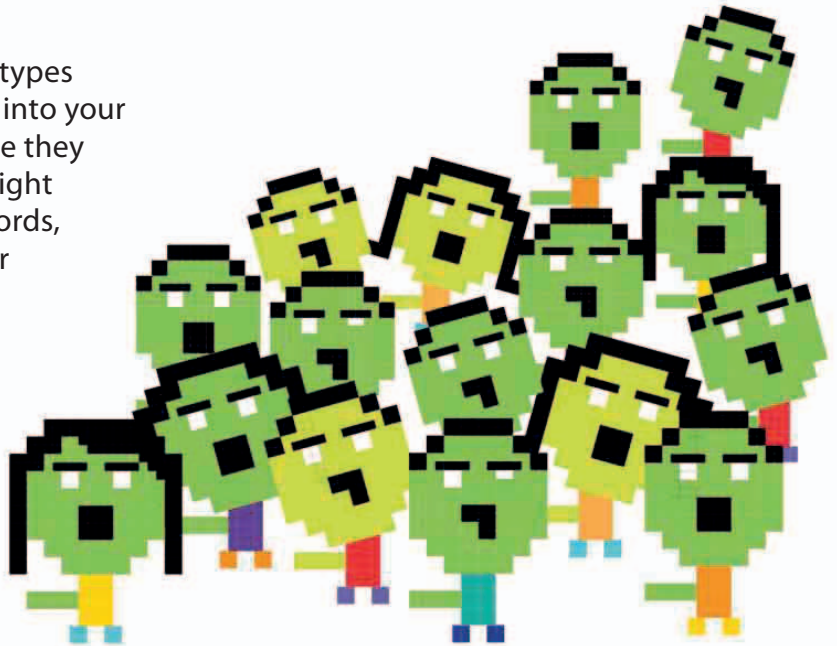

## Good software to the rescue

Thankfully, people aren't defenseless in the fight against malware. Anti-malware software has become big business, with many providers competing to provide the best protection. Two well-known examples are firewalls and antivirus programs.

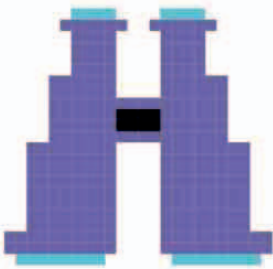

### △ **Antivirus programs**

Antivirus software tries to detect malware. It identifies bad programs by scanning files and comparing their contents with a database of suspicious code.



### △ **Firewalls**

Firewalls aim to prevent malware and dangerous network traffic from reaching your computer. They scan all incoming data from the Internet.



LINGO

## Hackers

Coders that study and write malware are known as “hackers”. Those who write malware to commit crimes are known as “black-hat” hackers, and those who write programs to try to protect against malware are known as “white-hat” hackers.



White-hat hacker

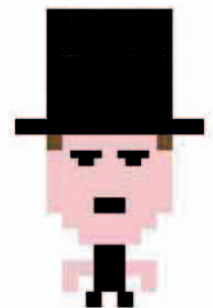

Black-hat hacker

# Mini computers

Computers don't have to be big or expensive. A wide range of small and cheap computers are available. Because of their small size and low cost, these computers are being used in lots of new and exciting ways.

## SEE ALSO

◀ **180–181** Inside a computer

◀ **202–203** Busy programs

## Raspberry Pi

The Pi is a credit-card-sized computer, created to teach the basics of how computers work. For its size it is impressively powerful, with the ability to run similar programs to a modern PC.

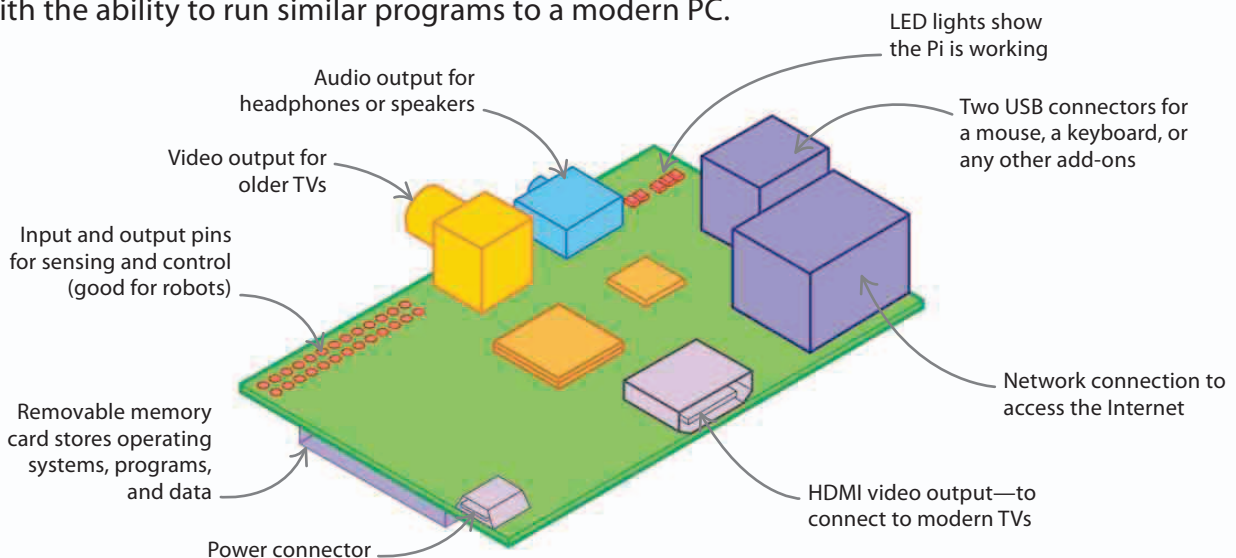

## Arduino

The Arduino is cheaper than the Pi, but less powerful. It is often used as a low-cost and simple way to build custom electronic or robotic machines.

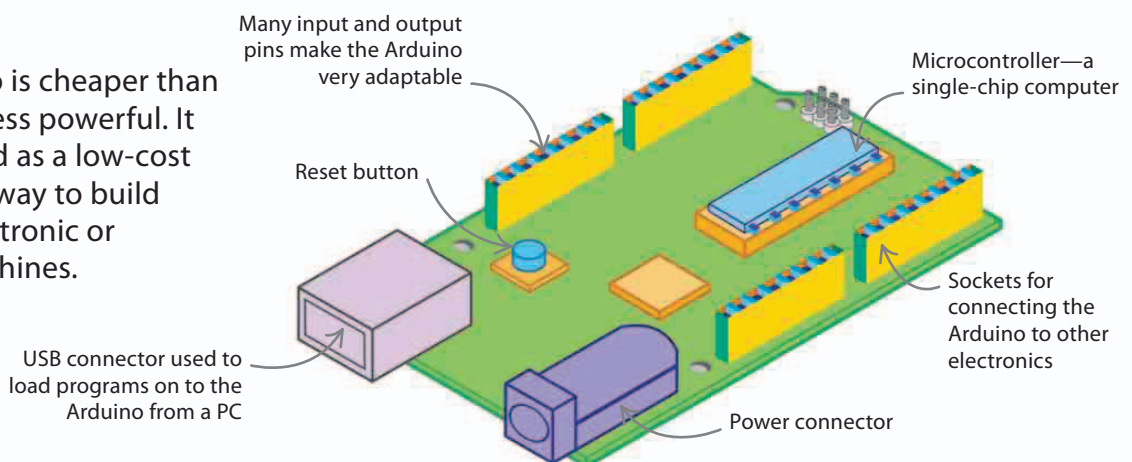



## Using mini computers

There are endless useful things a mini computer can do because of its many connection options. Here are just a few suggestions.

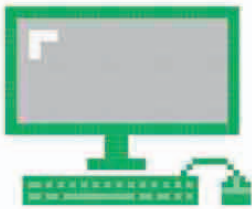

### △ Computer

Connect a keyboard, mouse, and monitor for a fully working desktop computer.



### △ Audio output

Connect a set of speakers and then send music to them over the network.



### △ Mobile phones

Connect the computer to the Internet using a mobile phone.

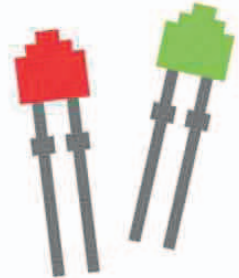

### △ Gadgets

Connect LED lights and other simple electronics to make robots or gadgets.



### △ Television

Connect a TV and use it as a media center to show all of your movies and pictures.

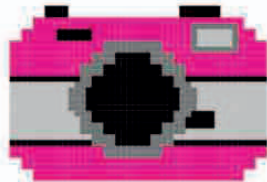

### △ Camera

Connect a basic camera to your mini computer to create your own webcam.



### △ USB

Connect a USB hard drive and share your files over your network.



### △ SD card

Change the programs on your mini computer just by swapping SD cards.

## ■ ■ REAL WORLD

### Home-built robots

With their small size, cost, and weight, mini computers are being used more and more to build different types of robot. For example:

**Weather balloons** that record weather conditions in the atmosphere.

**Mini vehicles** that can sense obstacles using sonar like a bat.

**Robotic arms** that pick up and move different objects.

Robotic spider controlled by the Arduino

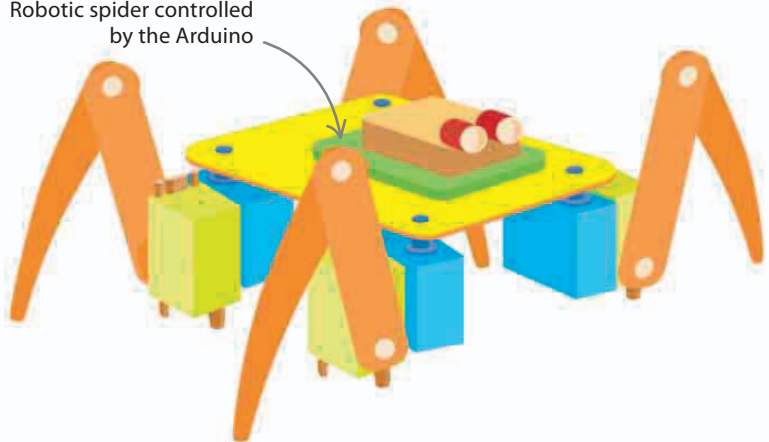

# Become a master programmer

The secret to becoming a master programmer is to have fun. As long as you're enjoying yourself, there's no limit to how skilled you can become at coding, whether as a hobby or a lifelong career.

## Ways to become a better programmer

Like skiing, learning the piano, or playing tennis, coding is a skill that you'll get better and better at over time. It can take years to become a true expert, but if you're having fun on the way, it will feel like an effortless journey. Here are a few tips to help you become a master programmer.

### SEE ALSO

◀ **176–177** What next?

◀ **214–215** Mini computers



### △ **Code a lot**

People say practice makes perfect—and it's true. The more code you write, the better you'll get. Keep going and you'll soon be an expert.

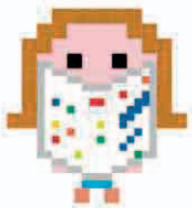

### ◁ **Be nosy**

Read websites and books about programming and try out other people's code. You'll pick up expert tips and tricks that might have taken you years to figure out on your own.

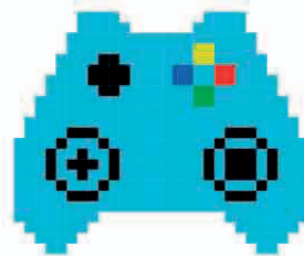

### △ **Steal ideas**

If you come across a great program, think how you might code it yourself. Look for clever ideas to use in your own code. All the best programmers copy each other's ideas and try to improve them.

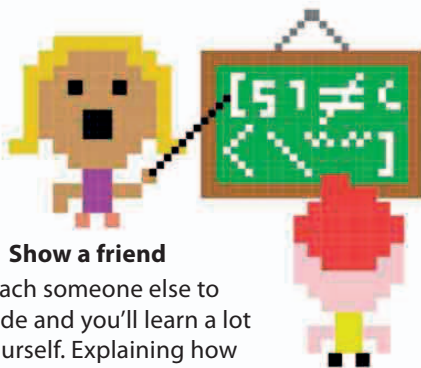

### ▷ **Show a friend**

Teach someone else to code and you'll learn a lot yourself. Explaining how coding works is a great way of making sure you understand it thoroughly.

### ▷ **Train your brain**

Your brain is like a muscle—if you exercise it, it will get stronger. Do things that help you think like a programmer. Solve logic puzzles and brainteasers, take up Sudoku, and work on your math.

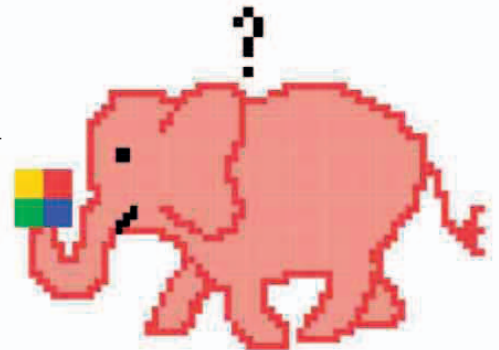

### ▷ Test your code

Test your code by entering crazy values to see what happens. See how well it stands up to errors. Try rewriting it to improve it or try rewriting someone else's—you'll learn all their secret tricks.

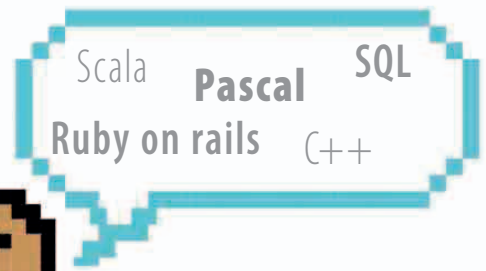
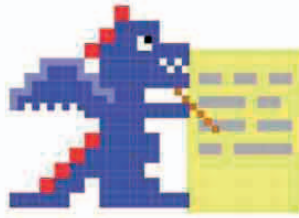

### △ Learn new languages

Become multilingual. Every new programming language you learn will teach you more about the ones you already know (or *thought* you knew). You can download free versions of most languages.

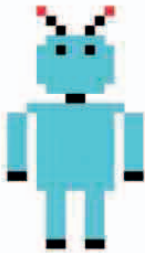

### ◁ Build a robot army

You can connect your computer to all sorts of programmable devices, from flashing LED lights to robots. It's fun and you'll learn lots as you figure out how to conquer the world.

### ▷ Pull a computer to bits

Take an old computer apart to see how it works (ask permission first!). There aren't many components, so it won't take long to figure out what all the bits are. Best of all, build your own computer and then run your code on it.

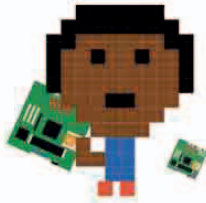

### ▷ Win a prize

When your skills develop, why not enter an online coding contest? There are lots to choose from at all different levels. The toughest are worldwide competitions like Google's Code Jam, but there are easier challenges too.



## REMEMBER

### Have fun!

Coding is a lot like trying to solve puzzles. It's challenging and you'll often get stuck. Sometimes it's frustrating. But you'll also have breakthroughs when you solve a problem and feel a buzz of excitement at seeing your code work. The best way to keeping coding fun is to take on challenges that suit you. If a project is too easy you'll get bored; if it's too hard you'll lose interest. Never be afraid to fiddle, tinker, experiment, and break the rules—let your curiosity lead you. But most of all, remember to have fun!

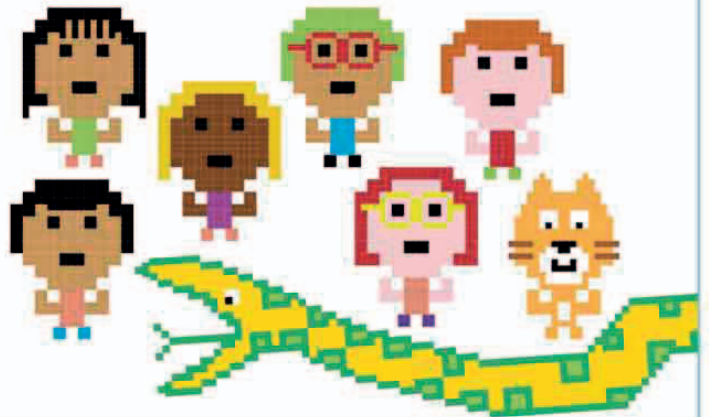

# Glossary

**algorithm**

A set of step-by-step instructions followed when performing a task: for example, by a computer program.

**ASCII**

“American Standard Code for Information Interchange”—a code used for storing text characters as binary code.

**binary code**

A way of writing numbers and data that uses only 0s and 1s.

**bit**

A binary digit—0 or 1. The smallest unit of digital information.

**Boolean expression**

A question that has only two possible answers, such as “true” and “false”.

**branch**

A point in a program where two different options are available to choose from.

**bug**

An error in a program’s code that makes it behave in an unexpected way.

**byte**

A unit of digital information that contains eight bits.

**call**

To use a function in a program.

**compression**

A way of making data smaller so that it takes up less storage space.

**computer network**

A way to link two or more computers together.

**container**

A part of a program that can be used to store a number of other data items.

**data**

Information, such as text, symbols, and numerical values.

**debug**

To look for and correct errors in a program.

**debugger**

A program that checks other programs for errors in their code.

**directory**

A place to store files to keep them organized.

**encryption**

A way of encoding data so that only certain people can read or access it.

**event**

Something a computer program can react to, such as a key being pressed or the mouse being clicked.

**execute**

See *run*.

**file**

A collection of data stored with a name.

**float**

A number with a decimal point in it.

**function**

A piece of code that does part of a larger task.

**gate**

Used by computers to make decisions. Gates use one or more input signals to produce an output signal, based on a rule. For example, “AND” gates produce a positive output only when both input signals are positive. Other gates include “OR” and “NOT”.

**GPU**

A graphics processing unit (GPU) allows images to be displayed on a computer screen.

**graphics**

Visual elements on a screen that are not text, such as pictures, icons, and symbols.

**GUI**

The GUI, or graphical user interface, is the name for the buttons and windows that make up the part of the program you can see and interact with.

**hacker**

A person who breaks into a computer system. “White hat” hackers work for computer security companies and look for problems in order to fix them. “Black hat” hackers break into computer systems to cause harm or to make profit from them.

**hardware**

The physical parts of a computer that you can see or touch, such as wires, the keyboard, and the display screen.

**hexadecimal**

A number system based on 16, where the numbers 10 to 15 are represented by the letters A to F.

**index number**

A number given to an item in a list. In Python, the index number of the first item will be 0, the second item 1, and so on.

**input**

Data that is entered into a computer: for example, from a microphone, keyboard, or mouse.

**integer**

Any number that does not contain a decimal point and is not written as a fraction (a whole number).

**interface**

The means by which the user interacts with software or hardware.

**IP address**

A series of numbers that makes up a computer's individual address when it is connected to the Internet.

**library**

A collection of functions that can be reused in other projects.

**loop**

Part of a program that repeats itself (to prevent the need for the same piece of code to be typed out multiple times).

**machine code**

The basic language understood by computers. Programming languages must be translated into machine code before the processor can read them.

**malware**

Software that is designed to harm or disrupt a computer. Malware is short for "malicious software".

**memory**

A computer chip inside a computer that stores data.

**module**

A section of code that performs a single part of an overall program.

**operator**

A symbol that performs a specific function: for example, "+" (addition) or "-" (subtraction).

**OS**

A computer's operating system (OS) provides the basis for other programs to run, and connects them to hardware.

**output**

Data that is produced by a computer program and viewed by the user.

**port**

A series of numbers used by a computer as the "address" for a specific program.

**processor**

A type of electronic chip inside a computer that runs programs.

**program**

A set of instructions that a computer follows in order to complete a task.

**programming language**

A language that is used to give instructions to a computer.

**random**

A function in a computer program that allows unpredictable outcomes. Useful when creating games.

**run**

The command to make a program start.

**server**

A computer that stores files accessible via a network.

**single-step**

A way of making a computer program run one step at a time, to check that each step is working properly.

**socket**

The combination of an IP address and a port, which lets programs send data directly to each other over the Internet.

**software**

The programs that run on a computer and control how it works.

**sprite**

A movable object.

**statement**

The smallest complete instruction a programming language can be broken down into.

**string**

A series of characters. Strings can contain numbers, letters, or symbols, such as a colon.

**syntax**

The rules that determine how a program must be structured in order for it to work properly.

**trojan**

A piece of malware that pretends to be another piece of software to trick the user.

**tuple**

A list of items separated by commas and surrounded by brackets.

**Unicode**

A universal code used by computers to represent thousands of symbols and text characters.

**variable**

A named place where you can store information that can be changed.

**virus**

A type of malware that works by multiplying itself to spread between computers.

# Index

Page numbers in **bold** refer to main entries.

## A

Ada 18  
 addition 52, 102, 112  
 Adobe Flash 25  
 AI *see* Artificial Intelligence  
 algorithms 16, 17, **150–1**, 218  
 Allen, Paul 200  
 ALU *see* arithmetic logic unit  
 American Standard Code for Information Interchange *see* ASCII  
 “and” block/operator 63, 103, 118, 119  
 AND gate 186  
 Android operating system 198, 207  
 anti-malware software 213  
 antivirus programs 213  
 apostrophes 115  
 Apple Mac  
   file management 193  
   operating system 190, 207  
   programming languages 198  
   Python 3 on 88, 90  
   Scratch on 25  
 apps, making **206–7**  
 Arduino **214**, 215  
 arithmetic logic unit (ALU) 181  
 arrow keys 163, 166  
 Artificial Intelligence (AI) **203**, 205  
 ASCII **184**, 218  
 audio output 181, 215

## B

Babbage, Charles 200  
 backgrounds/backdrop 23, 26  
   changes to 45  
   selecting from library 33, 74  
   switching 41  
 backpack, Scratch 82  
 banking 199, 202  
 bases 182–3  
 BASIC 199  
 battery, computer 181  
 beats 59  
 Berners-Lee, Tim 201  
 binary code/signals 15, **182–3**, 184, 185, 195, 218

bits 183, 189, 218  
 black-hat hackers 213  
 blank lines 117  
 blocks  
   colored 31  
   connecting 18  
   creating 72–3  
   defining 72, 73  
   functions of 31  
   help with 83  
   with inputs 73  
   programming 22  
   types of 31  
 blocks palette 27, 31, 32, 35, 38, 50  
 bomb disposal 203  
 Boole, George 186  
 Boolean expressions 62, 63, 64, 65, 111, 118–19, 120, 218  
 botnets, zombie 213  
 brackets  
   errors 94  
   in lists 128, 129  
   in tuples 134  
   using 112, 119  
 brain, training 216  
 branches/branching 65, 99, 100, 120–1, 218  
 breaks, inserting in loops 126–7  
 Brin, Sergei 201  
 broadcast blocks **70–1**, 77  
 browser windows 210, 211  
 Bubble blaster project 164–75  
 bugs **148–9**, 177, 207, 218  
 buttons  
   creating 152, 154–5  
   labelling 155  
   linking to events 162  
 bytes (B) 183, 192, 218

## C

C 18, 198  
 C++ 198  
 calculations 180, 181, 189  
   in Python 112  
   in Scratch 52–3  
   supercomputers 203  
 calling functions 104, **139**, 218  
 cameras 215  
 canvas 157, 158  
 cars 14  
 characters  
   between outputs 117  
   numbering in strings 115  
   in strings 114  
   Unicode 185  
 Chef 199  
 circles, drawing 157, 158  
 circuits, computer 187, 188, 189  
 clicking, and events 44, 66, 162  
 clock pulse 188  
 coordinates  
   drawing with 158  
   and location 168  
   and movement 166  
   in Python 157  
   in Scratch 56–7  
 COBOL 199  
 code windows 92, 93, **106–7**  
   errors in 94  
 coders 14, 15  
   becoming a coder 18–19  
   becoming a master programmer 216–17  
   famous 200–1  
   and games 204  
   think like a computer 16–17  
 coding  
   clear 143  
   computer programs 14–15  
   reading 176, 216  
   what is coding? 14–19  
 coding clubs 82, 207  
 coding contests 217  
 colors  
   adding to shapes 159  
   changing 60, 160  
   mixing 156  
   in Python 156–7  
   selecting 156  
 commands  
   Python and Scratch compared 102–5  
 commas  
   in lists 128  
   in tuples 134  
 comments, adding 143  
 comparison blocks/operators 62–3, 118–19  
 compass 39  
 compilers 191  
 components, computer 181, 217  
 compression **202**, 218  
 computer circuits 187, 188, 189  
 computer games *see* games  
 computer languages *see* programming languages  
 computer programmers *see* coders  
 computer programs 14–15

algorithms 16, 17  
 bad programs 212–13  
 essential 190–1  
 experimenting with 19  
 how they work 15  
 uses of 14  
 computers  
   deconstructing 217  
   invention of 201  
   main parts of 180–1  
   mini 214–15  
   supercomputers 203  
 console games 198  
 consoles 14, 204  
 containers **134**, 218  
 “continue” keyword 127  
 “Control” blocks 31, 65, 68  
 control unit 180  
 controls, game 174, 205  
 costumes **40–1**  
   and movement 23, 40, 41  
   random 61  
   Roll the dice project 60–1  
   and speech bubbles 41  
   switching 34, 40, 41  
 cryptography 202  
 CSS (Cascading Style Sheets) 208  
 cursor tools 26

## D

data 218  
   and functions 131  
   input 180  
   output 181  
   secret 202  
   sending via Internet 194, 195  
   theft 213  
 “Data” blocks 31, 50  
 data storage  
   in files 192–3  
   memory 180, 181, 188, 189  
   in variables 50  
 data types  
   converting 111  
   mixed 111  
   spotting 111  
   tuples and dictionaries 134–5  
 debugging **148–9**, 174, 177, 207, 218  
 decimal system 182  
 decisions  
   and branches 64–5  
   flowcharts 141  
   logic gates 186–7

dice simulator 155  
 dictionaries 135  
 direction 39  
 directories **193**, 218  
 directory trees 193  
 division 52, 102, 112  
 domain names 194  
 drawing  
   on a canvas 157, 165  
   with coordinates 158  
   pens and turtles 48–9, 122, 152  
 Drawing machine project 140–7  
 drums 59

## E

educational apps 206  
 electrical signals 195  
 “elif” command 121  
 “else-if” command *see* “elif”  
   command  
 emails  
   spam 213  
   websites 198, 208  
 encryption **202**, 218  
 “end” label 117  
 errors 94–5  
   finding and fixing 148–9  
 Escape the dragon! project 32–7  
 event handlers 166, 211  
 events 211, 218  
   reacting to **162–3**  
 “Events” blocks 31, 32, **44–5**  
 EXCLUSIVE OR gate 187  
 experimenting  
   with coding 19  
   with Python 176–7  
   with Scratch 82–3

## F

Facebook 201  
 false *see* true or false  
 fiberoptic cables 195  
 file browsers 190  
 files 218  
   compressing 202  
   corruption 213  
   managing 193  
   properties 192  
   sizes 192  
   storing data in **192–3**  
 firewalls 213

floats **110**, 218  
 flowcharts **141**, 146  
 folders 193  
 “for” loops 122, 124  
 “forever” block 23, 31, 32, 33, 38,  
   39, 46, 47, 125  
 forever loop 46, 47, 69, 103, 125,  
   133  
 Fortran 199  
 full stops 117  
 functions 72, **130–1**, 132–3, 218  
   calling 104, **130**, **139**  
   getting data back from 131  
   making 130  
   passing data to 131  
   using and naming 143  
   and variables 138–9

## G

gadgets 215  
 Game Boy 201  
 game engines 205  
 game logic 205  
 games 14, **204–5**  
   customizing 81  
   improving 174  
   in JavaScript 209  
   making with Python 177  
   for mobile devices 206  
   online 195  
   random numbers in 53  
   *see also* projects  
 Gates, Bill 200  
 gates, logic **186–7**, 218  
 Ghost game project 96–9  
 gigabytes (GB) 189, 192  
 global variables 138, 139  
 GNU/Linux operating system 201  
 Google 86, 201, 217  
 GPU 218  
 graphic designers 204  
 graphical user interface  
   *see* GUI  
 graphics 218  
   changing 160–1  
   color and coordinates 156–7  
   effects 43, 152, 153  
   games 205  
   making shapes 158–9  
 graphics processing unit  
   *see* GPU  
 grid, x and y 56, 158  
 GUI 154–9, 218

## H

hackers **213**, 218  
 hardware 15, 181, 191, 218  
   programming 198  
 hexadecimal 156, 183, 185, 218  
 high-level languages 191  
 Hopper, Grace 200  
 HTML (HyperText Markup  
 Language) 208, 209, 210

## I

IDLE  
   code and shell windows 106–7  
   color codes 107  
   and errors 148  
   how it works 93  
   and installation of Python  
     89, 90, 91  
   what is IDLE? **88**  
   working in **92–3**, 209  
 “if” block/command 64, 120  
 “if-elif-else” command 121  
 “if-else” command 120  
 “if-then” block/command 64, 66,  
   67, 103  
 “if-then-else” block/command  
   64, 65, 76, 103  
 “in” operator 119  
 indents 98  
 index numbers 115, 128, 218  
 infinite loops 125  
 input  
   blocks with 73  
   devices 162, 180, 189  
   logic gates 186–7  
   program 31, 100, 101, 106,  
     **116**, **180**, 218  
 “input()” function 101, 130  
 insertion sort 150  
 installation  
   Python 3 88–91  
   Scratch 24–5  
 instruments, musical 59  
 integers **110**, 219  
 Integrated DeveLopment  
   Environment *see* IDLE  
 interface  
   GUI 154–5  
   Scratch **26–7**, 49  
   user 140, 146–7, 219  
 Internet **194–5**  
   connecting to other  
   computers via 152

  connection to 19  
   programming for **208–9**  
 Internet browsers 209  
 Internet Protocol 194  
 interpreters 191  
 inverters 186  
 iOS devices 198  
 IP addresses **194**, 195, 219

## J

Java 18, 198  
 JavaScript 18, 198, 208, 209  
   using **210–11**  
 JPEGs 193

## K

keyboard  
   events 44, 66, 162, 163, 211  
   input function 116, 162, 163,  
     180  
 keys, dictionaries 135  
 kilobytes (KB) 183, 192

## L

laptops 181  
 latch circuits 189  
 letter commands 141  
 level designers 204  
 libraries 219  
   building your own 176  
   help and documentation  
     153  
   importing 153  
 light, data transmission as  
   pulses of 195  
 Linux 88, 201  
 lists  
   adding/deleting items 55, 105,  
     128, 129, 169  
   combining 129  
   commands 105  
   copying 137  
   creating 55, 105  
   in loops 129  
   playing with 55  
   putting tuples in 134  
   in Python **128–9**, 132–3  
   in Scratch **54–5**  
   using 55, 129, 167  
   in variables **136–7**

local variables 138, 139  
 logic circuits 187, 188, 189  
 logic errors 148  
 logic gates **186–7**, 188, 189  
 logical operators 118–19  
 LOGO 49  
 “Looks” blocks 31, 40, 42–3  
 loop blocks 46  
 loops 100, 103, 219  
   complex **68–9**  
   with conditions 104  
   escaping **126–7**  
   “for” 122, 124  
   forever 46, 47, 69, 103, 125  
   in JavaScript 211  
   lists in 129  
   main 99, 168, 169, 171  
   nested 69, 123  
   in Python **122–7**, 133  
   in Scratch **46–7**, **68–9**  
   simple **46–7**  
   skipping 124, 127  
   stopping 125  
   variable 123  
   while **124–5**  
 Lovelace, Ada 200  
 low-level languages 191

## M

Mac *see* Apple Mac  
 Mac OS X 190  
 machine code **188**, 191, 219  
 Malbolge 199  
 malware **212–13**, 219  
 Math module 152  
 math  
   in Python 102, **112–13**  
   in Scratch **52–3**, 102  
 MATLAB 18  
 medicine 203  
 megabytes (MB) 183, 189, 192  
 memory 180–1, **188–9**, 190,  
 192, 219  
 messages  
   reacting to 70  
   sending and receiving 70  
 microphones, and events 44, 45  
 Microsoft 200  
 Microsoft Windows  
   file management 193  
   operating system 190, 207  
   Python 3 on 88, 89  
   Scratch on 25  
 millennium bug 199

mini computers 214–15  
 Miyamoto, Shigeru 201  
 mobile phones 14, 204, 215  
   apps 206–7  
 modules 219  
   importing 153  
   Standard Library 152  
 Monkey mayhem project 74–81  
 motherboard 181  
 “Motion” blocks 31, 32, 33, 34, 36,  
 38–9, 57, 75  
 motion detector, webcam 45  
 mouse  
   control 25  
   events 162, 211  
   input function 180, 189  
 mouse-pointer  
   coordinates 56  
   following 69  
   pointing toward 32, 33, 36  
 movement  
   coordinates 57  
   and costumes 23, 40, 41  
   with keys 66, 163, 166  
   and “Sensing” blocks 66, 67  
   sprites 22, 23, **38–9**, 57  
 Mpegs 193  
 multiplication 52, 102, 112  
 music  
   adding 37, 79  
   files 192, 193, 202  
   making your own 59  
   playing 59  
   tempo 59  
 mutable/immutable objects  
 129

## N

name errors 95  
 NASA 86  
 negative numbers 56, 57  
 nested loops 47, 69, 123  
 network adaptors 181, 195  
 networks, computer 152,  
 194, 218  
 nibbles 183  
 NOT gate 186  
 notes, musical 59  
 numbers  
   binary and bases 182–3  
   comparing 62, 118  
   data types in Python 110  
   random 53, 104, 113, 152, 155

## O

Objective-C 198  
 Ook 199  
 open source movement 201  
 operating systems (OS) 25,  
 88–91, 92, **190–1**, 207, 219  
 operators 219  
   blocks 31, 52, 53  
   logical 118–19  
 “or” block/operator 63, 103, 118  
 OR gate 187  
 OS *see* operating systems  
 output  
   and branching 120–1  
   devices 180, 181, 189  
   logic gates 186–7  
   program 31, 92, 100, 101,  
   106, 108, **116–17**, **180–1**

## P

packets 194, 195  
 Page, Larry 201  
 painting area 60, 61  
 passwords, theft of 213  
 paths 193  
 “Pen” blocks 31, **48–9**, 87, 107  
 Peters, Tim 151  
 photograph files 193  
 Pi 214  
 pictures, files 192, 193  
 Piet 199  
 pilots 205  
 Pixar 86  
 pixels 156  
 player’s name 50  
 PNGs 193  
 pop-up boxes/windows 146,  
 209, 210  
 ports **195**, 219  
 position  
   coordinates 56–7  
   random 43, 57  
 “print()” function 87, 101, 102,  
 108, 109, 116, 117, 130  
 printers 181  
 processors 100, 101, 180–1,  
 188–9, 190, 203, 219  
 program flow 100–1  
 programming languages 15, 18,  
 19, 22, 49, 83, 198–9, 219  
   conversion into machine code  
   188  
   first 200

from the past 199  
 and interpreters 191  
 learning new 217  
 popular 198  
 Python and Scratch commands  
   compared 102–5  
   text-based 86  
   weird 199  
 programs *see* computer  
 programs  
 projects 11, 23  
 Bubble blaster 164–75  
 Drawing machine 140–7  
 Escape the dragon! 32–7  
 Ghost game 96–9  
 Monkey mayhem 74–81  
 remixing existing 82  
 Roll the dice 60–1  
 Silly sentences 132–3  
 PS4 204  
 pseudocode **143**, 144, 147  
 Pygame **153**, 177  
 Python 19, 83, **84–177**  
   algorithms 150–1  
   ASCII in 184  
   Booleans 111  
   branching 120–1  
   Bubble blaster project 164–75  
   bugs and debugging 148–9  
   code structure 98–9  
   color and coordinates 156–7  
   color codes 107  
   different versions of 177  
   Drawing machine project  
   140–7  
   errors 94–5  
   escaping loops 126–7  
   functions 130–1, 132–3  
   Ghost game project 96–9  
   harder commands 104–5  
   input and output 116–17  
   installing 88–91  
   introducing IDLE 92–3  
   libraries 152–3  
   lists 128–9, 132–3  
   lists in variables 136–7  
   loops in 122–7, 133  
   making decisions 118–19  
   making games with 177  
   making shapes 158–9  
   making windows 154–5  
   math in 112–13  
   numbers in 110  
   print in 87  
   program flow 100–1  
   reacting to events 162–3



saving work 88  
 and Scratch 87, 101, 102–5,  
 124, 125  
 scripts 101  
 shell and code windows 92,  
 93, 106–7  
 shortcuts 171  
 Silly sentences project 132–3  
 simple commands 102–3  
 sorting in 151  
 strings in 110, 114–15, 117  
 tuples and dictionaries 134–5  
 turtle graphics 87  
 types of data 110–11  
 Unicode in 185  
 variables 99, 101, 108–9, 116  
 variables and functions 138–9  
 website 89  
 what is Python? 19, 86–7  
 what next? 176–7  
 while loops 124–5

## Q

questions  
 asking 54  
 combining 63  
 true or false 62–3  
 quote marks  
 errors 94  
 in lists 128  
 in strings 110, 114, 116

## R

radio waves 195  
 RAM 189  
 “randint()” function 98, 99, 101,  
 104, 113, 130, 153, 155  
 Random Access Memory  
 see RAM  
 Random module 152, 153, 157  
 random numbers 53, 104, 113,  
 152, 155  
 random positions 43, 57  
 Raspberry Pi 25, **214**  
 reacting to events 162–3  
 readable code 133  
 remainders 53  
 repeat loops 46, 122, 211  
 “repeat until” block 68, 76, 77,  
 78, 124  
 rewriting code 217  
 robots 16, 203, 217

home-built 215  
 Roll the dice project 60–1  
 rotation  
 styles 38  
 tools 61  
 routers 194, 195  
 Ruby 18  
 running  
 programs 23, 102, 106  
 scripts 30  
 runtime errors 148

## S

saving your work 11  
 in Python 88, 93, 106, 107  
 in Scratch 24, 25, 33  
 saying things (in Python) 161  
 score 50, 79, 99, 172–3  
 scoreboards 172  
 Scratch **20–83**  
 account 24  
 adding sounds **58–9**, 79  
 backpack 82  
 blocks 30–1, 72–3  
 coordinates 56–7  
 complex loops 68–9  
 costumes 40–1  
 creating blocks 72–3  
 decisions and branches 64–5  
 Escape the dragon! project  
 32–7  
 events 44–5  
 experimenting with 82–3  
 harder commands 104–5  
 help menu 83  
 hide and seek 42–3  
 installing and launching 24–5  
 interface **26–7**, 49  
 lists 55  
 make some noise 58–9  
 making things move 38–9  
 math in 52–3  
 menu and tools 26  
 and microphones 45  
 Monkey mayhem project  
 74–81  
 pens and turtles **48–9**, 87  
 and Python 87, 102–5, 124, 125  
 and Python’s Ghost game 101  
 Roll the dice project 60–1  
 scripts and colored blocks  
**30–1**, 101  
 sending messages 70–1  
 sensing and detecting 66–7

simple commands 102–3  
 simple loops 46–7  
 software 24  
 special effects 42–3  
 sprites 28–9  
 strings and lists 54–5  
 true or false 62–3  
 typical programs 23  
 understanding 22  
 variables **50–1**, 108  
 versions of 25  
 and webcams 45  
 website 24, 82  
 what is Scratch? 18, **22–3**  
 screens 181  
 scripts 22, 23  
 building 27  
 and colored blocks 30–1  
 flow of 30  
 pausing 69  
 in Python 101  
 repeating 68  
 running 30  
 in Scratch **30–1**, 101  
 and sprites 28  
 stopping 30, 68  
 testing 30  
 scripts area 27  
 scripts tab 27  
 scriptwriters 204  
 SD cards 215  
 secret data 202  
 selection sort 151  
 “Sensing” blocks 31, 34, 36, 51,  
 65, 66–7, 75  
 separators 117  
 servers 219  
 shapes  
 adding color 159  
 drawing 140  
 making 158–9  
 moving 160  
 naming 160  
 shell windows 92, 93, **106–7**, 116  
 errors in 95  
 silicon chips 188, 189  
 Silly sentences project 132–3  
 skipping, in loops 127  
 slicing 115  
 smartphones 206  
 social apps 206  
 Socket module 152  
 sockets **195**, 219  
 software 14, 15, 219  
 sorting algorithms 150–1  
 “Sound” blocks 31, 58–9

sound designers 204  
 sound library 79  
 sounds 22, 23  
 adding to program **58–9**, 79  
 detectors 45  
 in games 205  
 playing 58  
 selecting from library 37, 58  
 volume control 58

spam 213  
 speakers 181  
 speech bubbles 22, 28, 87, 101  
 adding 41, 161  
 conversations 71  
 speed, setting 51, 77  
 “split()” function 144  
 sprites 22, 23, **28–9**, **39**, 219  
 adding graphic effects 43  
 adding more 76–7, 80  
 adding sounds 58–9  
 changing size 43  
 changing time or speed 35, 51  
 coordinates 56–7  
 collisions 67  
 communication between  
 70–1  
 controlling 31, 66  
 copying or deleting 29  
 creating and editing **29**, 34, 36  
 designing your own 39  
 direction 39  
 and events 44–5  
 hiding and showing 42  
 in the interface 28  
 movement 22, 23, **38–9**, 57,  
 66–7  
 naming 29  
 pen tools 48–9  
 renaming 29  
 rotation styles 38  
 and scripts 28  
 selecting from library 34, 36,  
 39, 75, 76  
 and “Sensing” blocks 66–7  
 sprite list 27  
 turtle graphics 49  
 and variables 35, **50–1**  
 what they can do 28

square roots 53  
 stage 23, 25, 27  
 Standard Library modules 152  
 stop button 30  
 stopping programs 102  
 strategy games 205  
 strings 219  
 adding 114

assigning 108  
 comparing 63, 118, 119  
 creating 114  
 joining 105  
 length of 114  
 operators 119  
 in Python 110, **114–15**, 117  
 in Scratch **54–5**  
 separating 117  
 subprograms *see* functions  
 subtraction 52, 102, 112  
 supercomputers 203  
 surgeons 205  
 symbols, choice of 143  
 syntax 219  
   errors 94, 148

## T

tablets 25, 206  
 tabs 26, 27  
 teleporting 43  
 television 215  
 tempo 59  
 terabytes (TB) 192  
 testers, game 204  
 text editors 88  
 text files 193  
 text messages 14  
 text-based programming  
   languages 86  
 time limit 172–3  
 Time module 152  
 Tkinter module 152, 154–5, 156,  
   157, 158, 159, 162, 165, 176  
 transistors 188  
 travel apps 206  
 Trojans **212**, 213, 219  
 true or false **62–3**, 64, 111,  
   118–21, 125  
 tuples **134**, 219  
 Turing, Alan 200

turtle graphics 49, 87, 105, 107  
   commands 105, 145  
   Drawing machine project  
     140–7  
   and loops 122  
 Turtle module 152, 176

## U

Ubuntu  
   file management 193  
   Python 3 on 88, 91  
   Scratch on 25  
 Unicode **185**, 219  
 upper/lower case 94  
 USBs 215  
 user interface 140, 146–7, 219

## V

values  
   assigning to variables 108,  
     109, 113, 118, 136  
   changing 136  
   in dictionaries 135  
   and functions 131  
 variables 35, 219  
   assigning a value to 108, 109,  
     113, 118, 136  
   changing contents of 109  
   comparing 62, 63, 118  
   creating **50**, 54, 77, 102, **108**  
   deleting 51  
   and functions 138–9  
   global 138, 139  
   lists in 136–7  
   local 138, 139  
   loop variables 123  
   naming 50, 109, 143  
   in Python 99, 101, **108–9**, 116,  
     **138–9**

read-only 51  
 results in 52  
 in Scratch **50–1**, 108  
 splitting tuples into 134  
 strings in 114  
   using 51, 109  
 video files 192, 193  
 video games **204–5**  
   writing 153  
 viruses **212–13**, 219  
 visual output 181  
 volume control 58  
 von Neumann, John 180

## W

washing machines 14  
 watches 206  
 wearable technology 206  
 weather forecasting 199, 203,  
   206, 215  
 web browsers 86, 195, 198  
 web servers 198  
 webcams, and events 44, 45  
 websites  
   construction 208–9  
   email 198, 208  
   interactive 198, 208, 210, 211  
   Python 89  
   Scratch 24, 82  
 while loops 124–5  
 white-hat hackers 213  
 Wikipedia 201  
 Windows *see* Microsoft Windows  
 windows  
   code and shell 92, 93, 106–7  
   making 152, 154–5, 165  
 word processing 86  
 words, comparing 63  
 World Wide Web 201  
 worms 212, 213

## X

x and y coordinates 56, 57, 157,  
   158, 166, 168  
 Xbox One 204

## Y

Yokoi, Gunpei 201

## Z

zombie botnets 213  
 Zuckerberg, Mark 201

# Acknowledgments

DORLING KINDERSLEY would like to thank: Max Albert for technical assistance on the US edition; Vicky Short, Mandy Earey, Sandra Perry, and Tannishtha Chakraborty for their design assistance; Olivia Stanford for her editorial assistance; Caroline Hunt for proofreading; Helen Peters for the index; and Adam Brackenbury for creative technical support.

DORLING KINDERSLEY INDIA would like to thank: Kanika Mittal for design assistance; Pawan Kumar for pre-production assistance; and Saloni Singh for editorial management of the jackets team.

Scratch is developed by the Lifelong Kindergarten Group at MIT Media Lab. See <http://scratch.mit.edu>

Python is copyright © 2001–2013 Python Software Foundation; All Rights Reserved.